

A



Surname \_\_\_\_\_

Other Names \_\_\_\_\_

Centre Number \_\_\_\_\_

Candidate Number \_\_\_\_\_

Candidate Signature \_\_\_\_\_

**AS**

**PHYSICS**

**Paper 2**

**7407/2**

**Thursday 9 June 2016      Afternoon**

**Time allowed: 1 hour 30 minutes**

**For this paper you must have:**

- a pencil
- a ruler
- a calculator
- a Data and Formulae booklet.

**At the top of the page, write your surname and other names, your centre number, your candidate number and add your signature.**

**[Turn over]**



J U N 1 6 7 4 0 7 2 0 1

## INSTRUCTIONS

- Use black ink or black ball-point pen.
- Answer ALL questions.
- You must answer the questions in the spaces provided. Do not write on blank pages.
- Do all rough work in this book. Cross through any work you do not want to be marked.
- Show all your working.



## INFORMATION

- The marks for questions are shown in brackets.
- The maximum mark for this paper is 70.
- You are expected to use a calculator where appropriate.
- A Data and Formulae Booklet is provided as a loose insert.

**DO NOT TURN OVER UNTIL TOLD TO DO SO**



**SECTION A**

**Answer ALL questions in this section.**

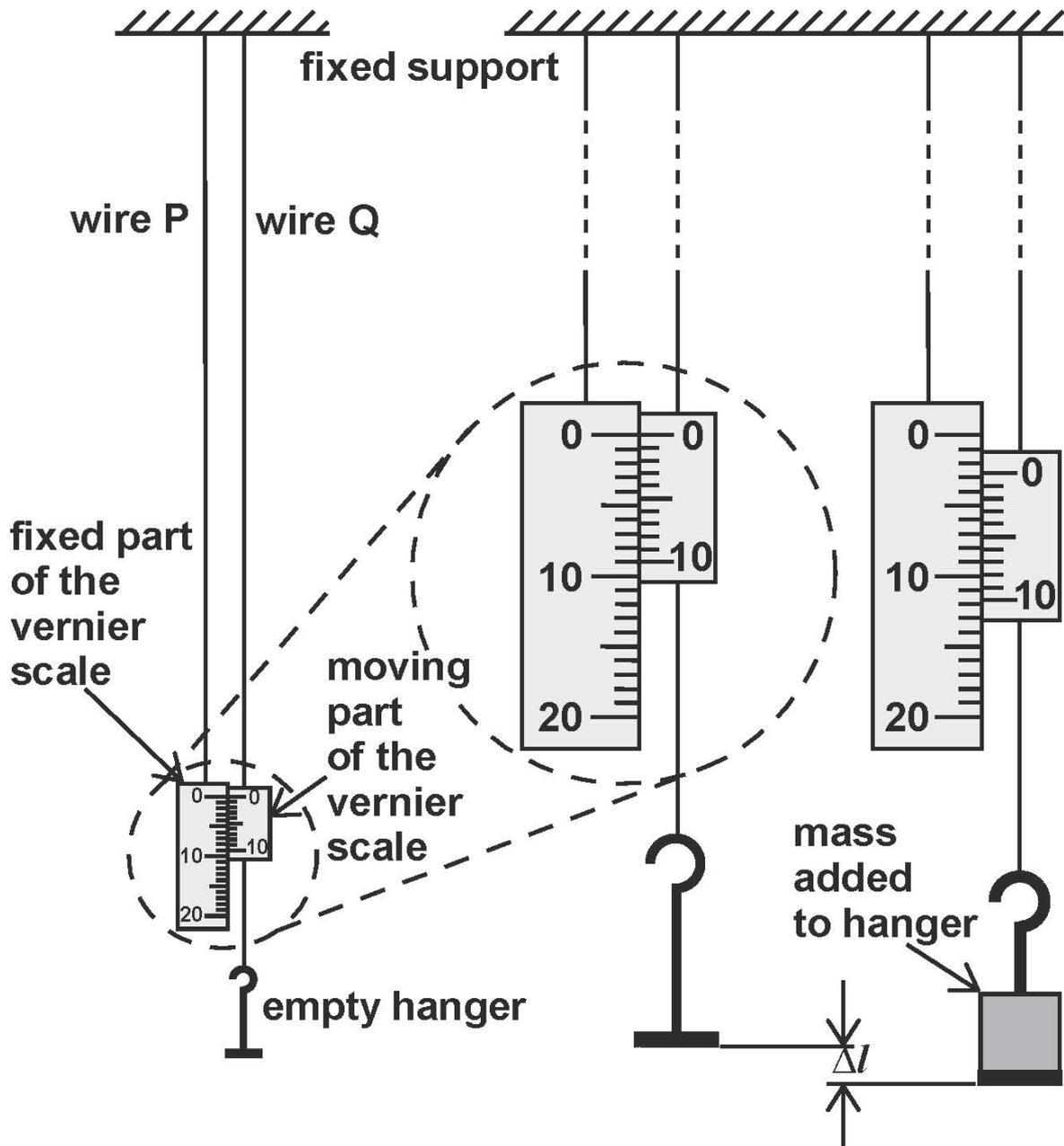
**0 1** This question is about the determination of the Young modulus of the metal of a wire.

**In an experiment, two vertical wires P and Q are suspended from a fixed support. The fixed part of a vernier scale is attached to P and the moving part of the scale is attached to Q. The divisions on the fixed part of the scale are in mm.**

**An empty mass hanger is attached to Q and the scale is set to zero. A load is added to the mass hanger so that the extension of Q can be measured as shown in Figure 1.**



FIGURE 1



- 0 1 . 1 The reading on the vernier scale can be used to determine  $\Delta l$ , the extension of Q. Determine  $\Delta l$  using Figure 1. [1 mark]

$$\Delta l = \underline{\hspace{2cm}} \text{ mm}$$

[Turn over]

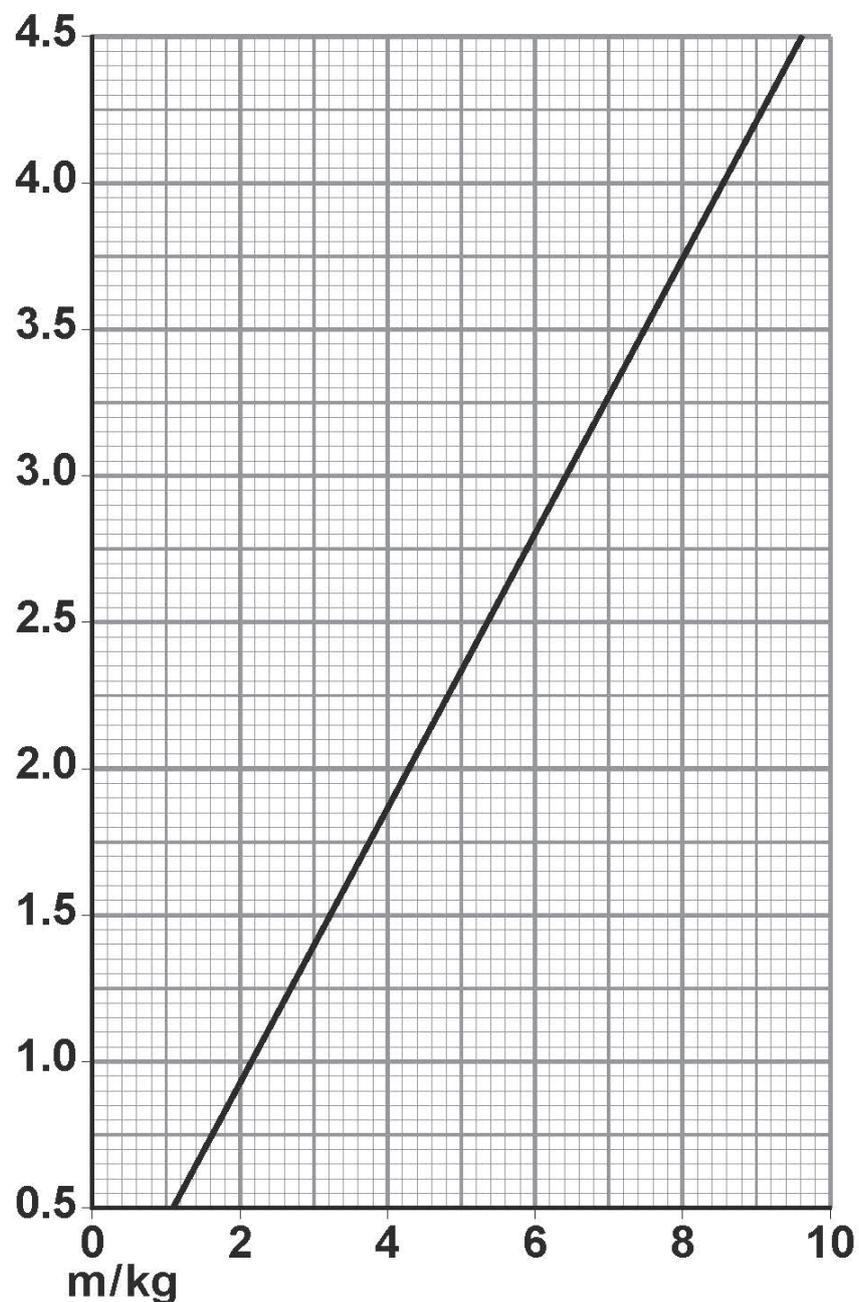


- 01.2 Figure 2 shows how  $\Delta l$  varies with  $m$ , the mass added to the hanger.  
Determine the mass added to the hanger shown in Figure 1. [1 mark]

mass = \_\_\_\_\_ kg

FIGURE 2

$\Delta l$ /mm



**01.3** A student uses digital vernier callipers to measure the diameter of Q. She places Q between the jaws of the callipers and records the reading indicated. Without pressing the zero button she removes Q and closes the jaws.

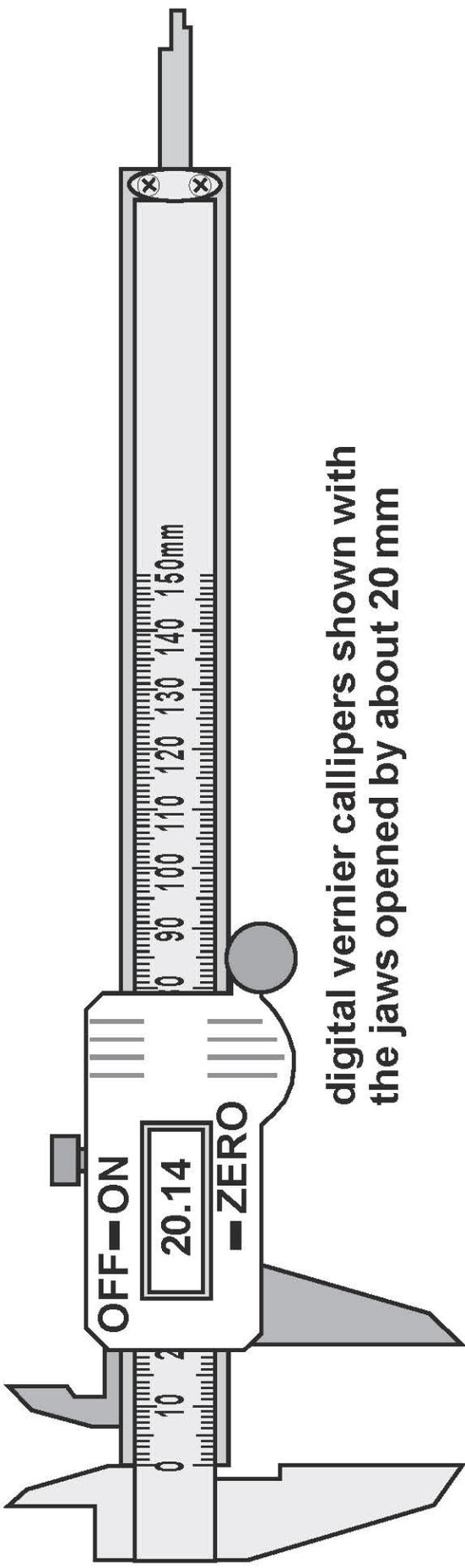
Views of the callipers before and after she closes the jaws are shown on the next page in Figure 3.

[Turn over]

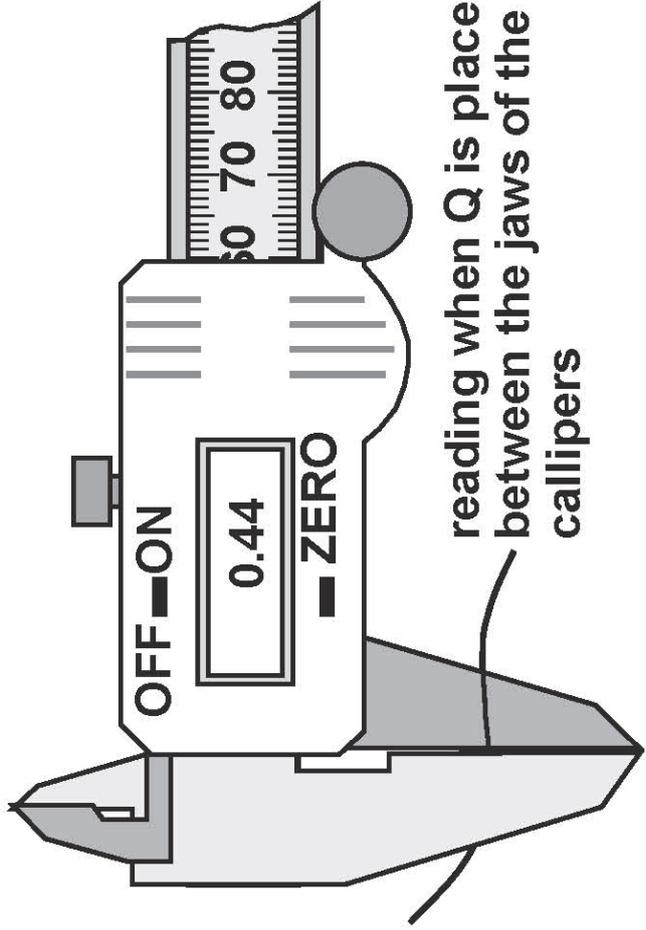




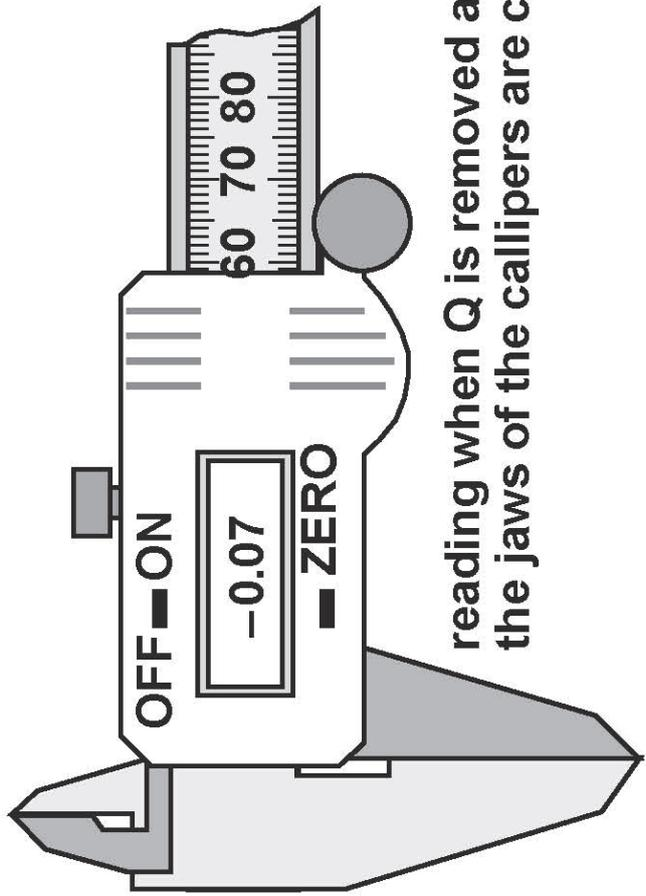
FIGURE 3



digital vernier callipers shown with the jaws opened by about 20 mm



reading when Q is placed between the jaws of the callipers



reading when Q is removed and the jaws of the callipers are closed



Calculate the true diameter of Q. [1 mark]

diameter = \_\_\_\_\_ mm

0 1 . 4 The original length of Q was 1.82 m.

Determine the Young modulus of the metal in Q.  
[4 marks]

Young modulus = \_\_\_\_\_ Pa



[Turn over]

**01.5** The student repeats her experiment using a wire of the same original length and metal but with a smaller diameter.

**Discuss TWO ways this change might affect the percentage uncertainty in her result for the Young modulus. [4 marks]**

**1** \_\_\_\_\_  
\_\_\_\_\_  
\_\_\_\_\_  
\_\_\_\_\_

**2** \_\_\_\_\_  
\_\_\_\_\_  
\_\_\_\_\_  
\_\_\_\_\_

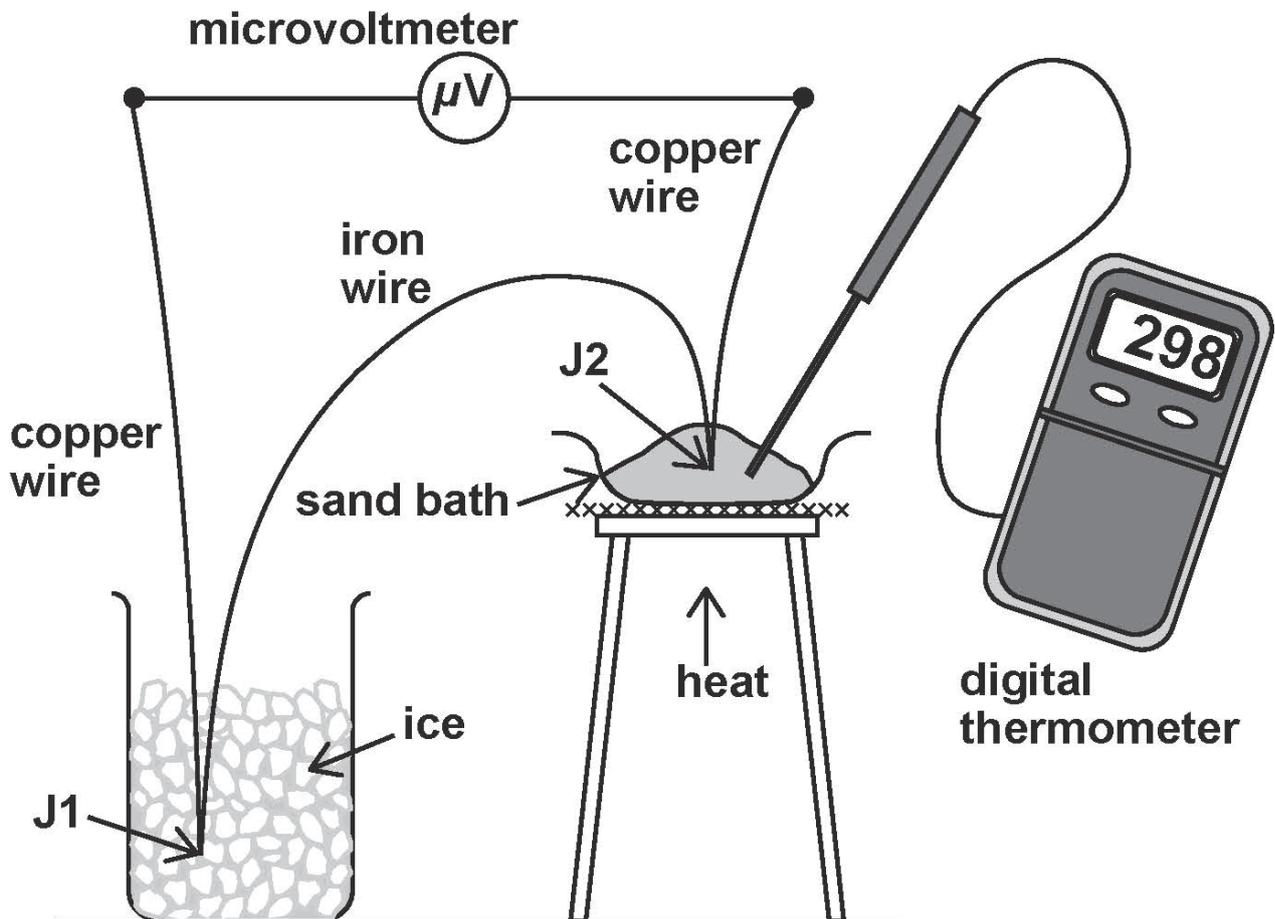


0 2

Lengths of copper and iron wire are joined together to form junctions J1 and J2. When J1 and J2 are at different temperatures an emf  $\varepsilon$  is generated between them. This emf is measured using a microvoltmeter.

Figure 4 shows J1 kept at 0 °C while J2 is heated in a sand bath to a temperature  $\theta$  measured by a digital thermometer.

FIGURE 4



[Turn over]



An experiment is carried out to determine how  $\varepsilon$  depends on  $\theta$ .

The results of the experiment are shown in Table 1 and a graph of these data is shown in Figure 5.

**TABLE 1**

$\theta / ^\circ\text{C}$	$\varepsilon / \mu\text{V}$
200	1336
226	1402
258	1450
298	1456
328	1423
362	1345
392	1241

**0 2 . 1** Plot the points corresponding to  $\theta = 258 ^\circ\text{C}$  and  $\theta = 298 ^\circ\text{C}$  on Figure 5. [1 mark]

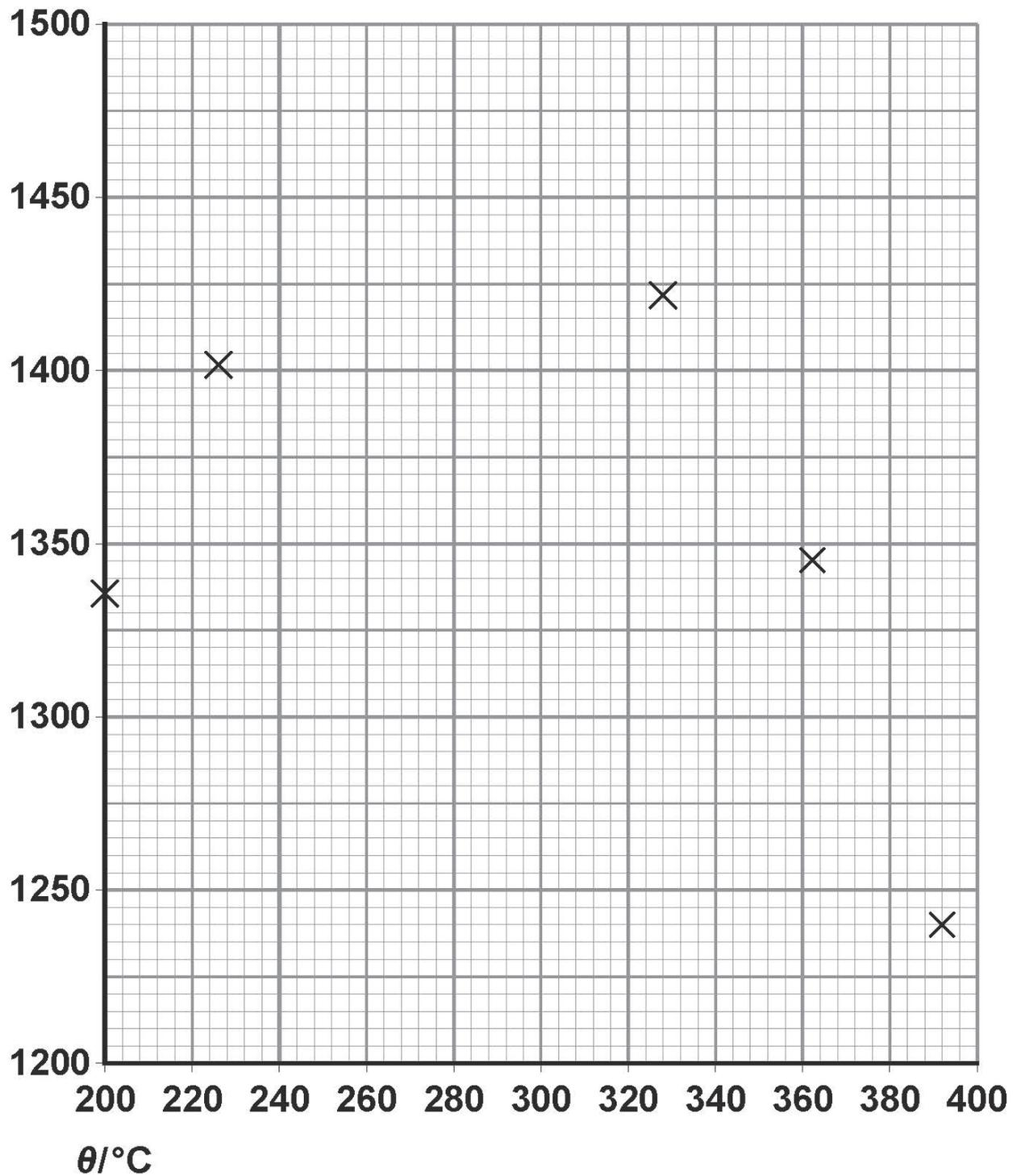
**0 2 . 2** Draw a suitable best fit line on Figure 5. [1 mark]

**0 2 . 3** Determine the maximum value of  $\varepsilon$ . [1 mark]

maximum value of  $\varepsilon =$  \_\_\_\_\_  $\mu\text{V}$



FIGURE 5

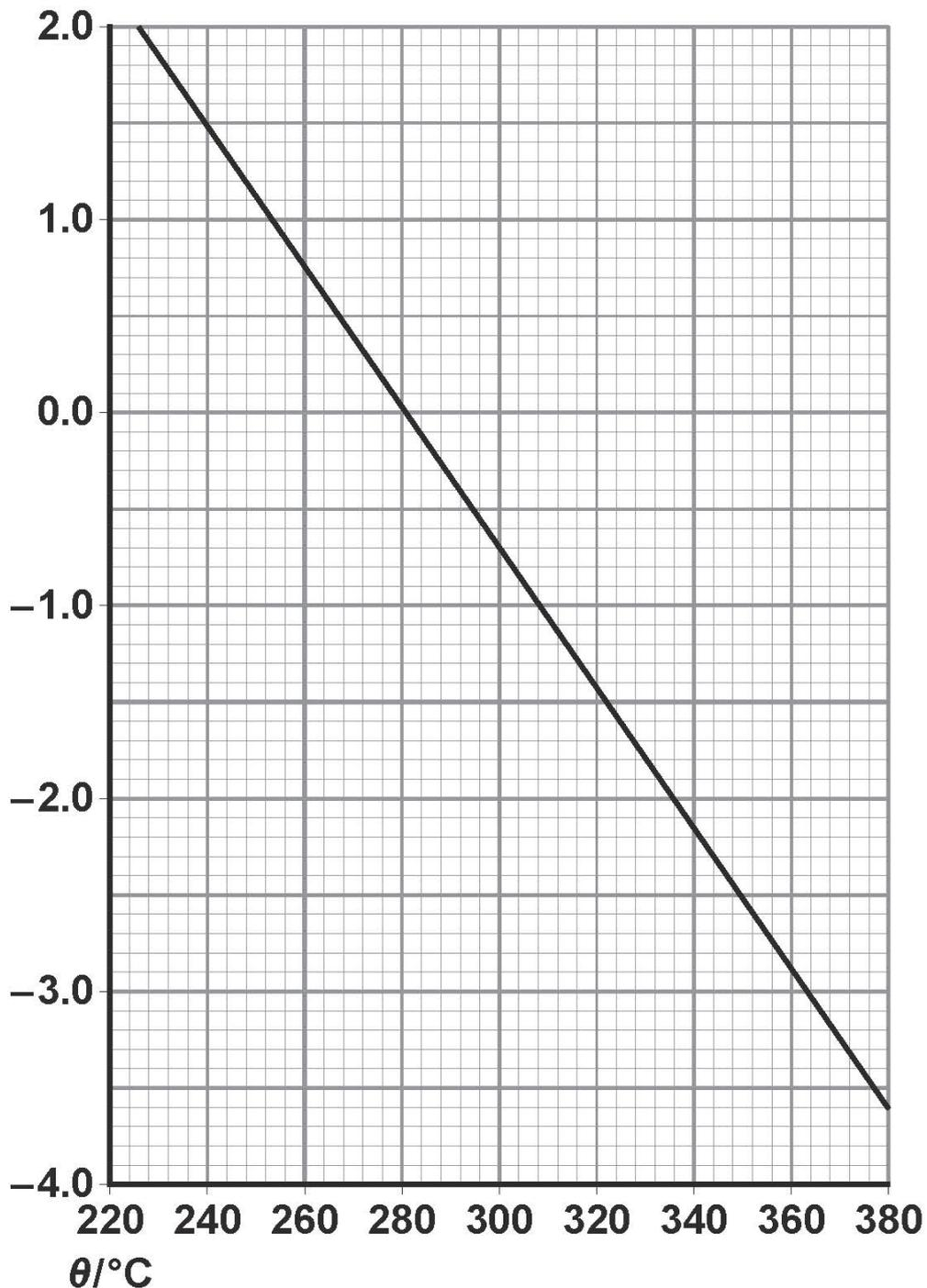
 $\varepsilon/\mu\text{V}$ 

[Turn over]



- 0 2 . 4 The gradient  $G$  of the graph in Figure 5 is measured for values of  $\theta$  between  $220\text{ }^{\circ}\text{C}$  and  $380\text{ }^{\circ}\text{C}$ . A graph of  $G$  against  $\theta$  is plotted in Figure 6.

FIGURE 6

 $G/\mu\text{V }^{\circ}\text{C}^{-1}$ 



BLANK PAGE





**0 2 . 5** It can be shown that  $G$  is given by

$$G = \beta\theta + \alpha$$

where  $\alpha$  and  $\beta$  are constants.

Determine  $\alpha$ . [2 marks]

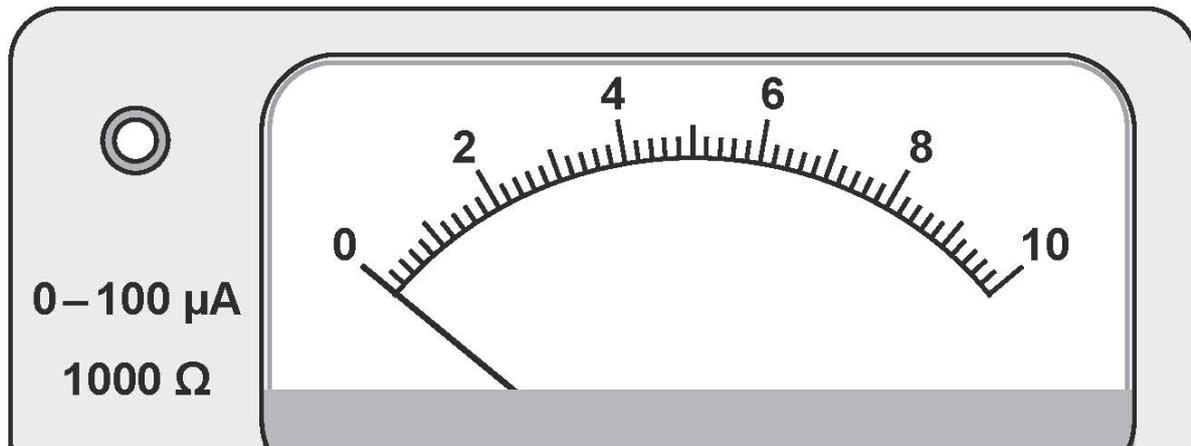
$$\alpha = \underline{\hspace{15em}} \mu\text{V } ^\circ\text{C}^{-1}$$

[Turn over]



- 02.6** A student decides to carry out a similar experiment. The student thinks the meter in Figure 7 could be used as the microvoltmeter to measure  $\varepsilon$ .

FIGURE 7



When this meter indicates a maximum reading and the needle points to the right-hand end of the scale (full-scale deflection), the current in the meter is  $100 \mu\text{A}$ . The meter has a resistance of  $1000 \Omega$ .

Calculate the full-scale deflection of this meter when used as a microvoltmeter.[1 mark]

full-scale deflection = \_\_\_\_\_  $\mu\text{V}$



**02.7** The scale on the meter has 50 divisions between zero and full-scale deflection.

**Discuss why this meter is not suitable for carrying out the experiment. [2 marks]**

---

---

---

---

---

---

---

---

---

---

**END OF SECTION A**

**[Turn over]**

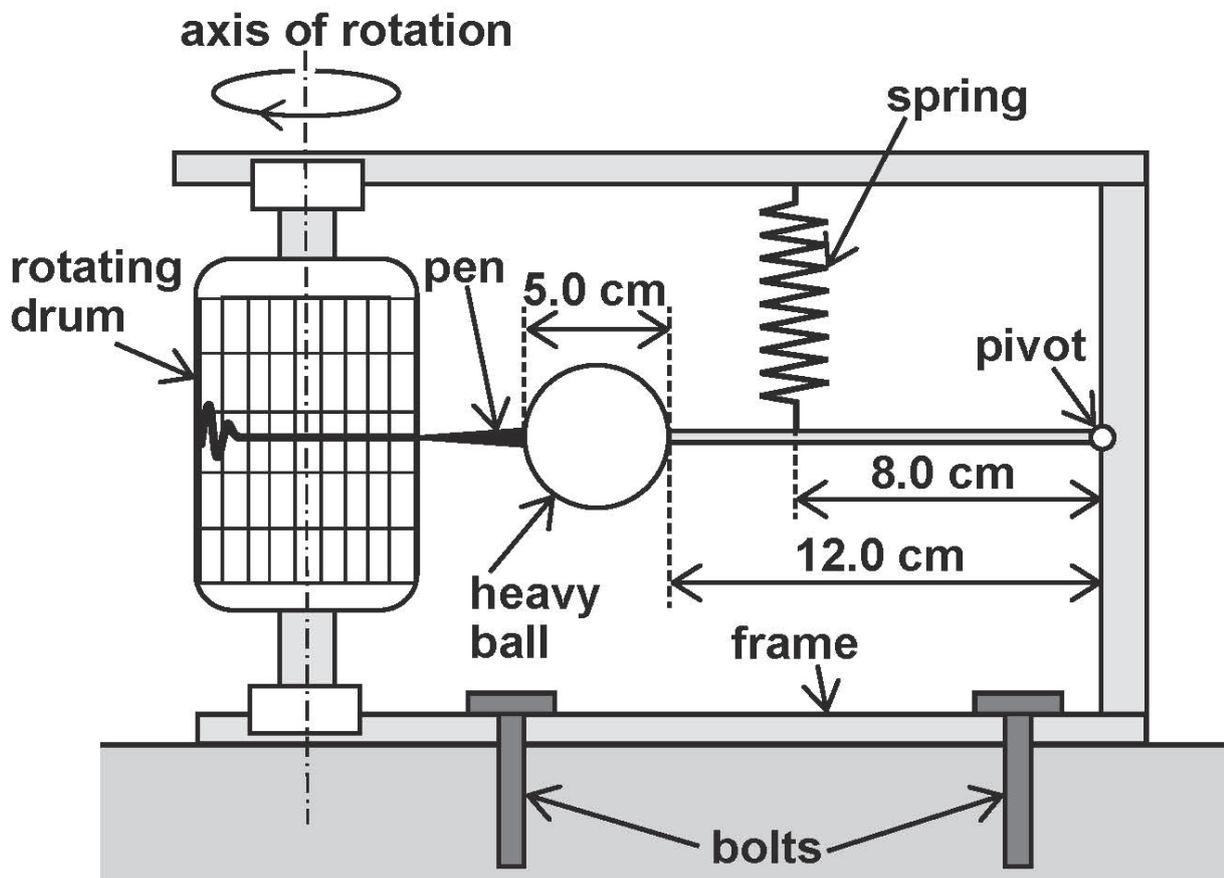


## SECTION B

Answer ALL questions in this section.

- 03** A seismometer is a device that is used to record the movement of the ground during an earthquake. A simple seismometer is shown in Figure 8.

FIGURE 8



A heavy spherical ball is attached to a pivot by a rod so that the rod and ball can move in a vertical plane. The rod is suspended by a spring so that, in equilibrium, the spring is vertical and the rod is horizontal. A pen is attached to the ball.



The pen draws a line on graph paper attached to a drum rotating about a vertical axis. Bolts secure the seismometer to the ground so that the frame of the seismometer moves during the earthquake.

- 03.1** The ball is made of steel of density  $8030 \text{ kg m}^{-3}$  and has a diameter of 5.0 cm.

Show that the weight of the ball is approximately 5 N. [3 marks]

- 03.2** The distance from the surface of the ball to the pivot is 12.0 cm, as shown in Figure 8.

Calculate the moment of the weight of the ball about the pivot when the rod is horizontal. Give an appropriate unit for your answer.

[3 marks]

moment = \_\_\_\_\_ unit = \_\_\_\_\_

[Turn over]



- 03.3** The spring is attached at a distance of 8.0 cm from the pivot and the spring has a stiffness of  $100 \text{ N m}^{-1}$ .

Calculate the extension of the spring when the rod is horizontal and the spring is vertical. You may assume the mass of the pen and the mass of the rod are negligible.  
[3 marks]

extension = \_\_\_\_\_ m



**03.4** Before an earthquake occurs, the line being drawn on the graph paper is horizontal.

**Explain what happens to the line on the graph paper when an earthquake is detected and the frame of the seismometer accelerates rapidly downwards. [2 marks]**

---

---

---

---

---

---

---

---

---

---

**[Turn over]**

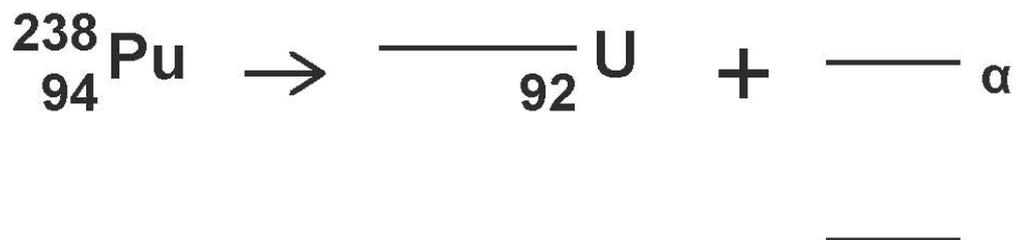


04

A Radioisotope Thermonuclear Generator (RTG) is a device that uses some of the energy from radioactive decay to generate electricity. The Mars rover Curiosity includes an RTG that contains plutonium-238. The plutonium undergoes alpha decay and some of the energy is used to generate about 100 W of electrical power.

04.1

Complete the equation for the alpha decay of plutonium-238. [2 marks]



04.2

Only 6% of the energy from the decay is used to generate electricity.

Calculate the rate at which energy is transferred from the decay of plutonium-238 on Curiosity. [1 mark]

rate of energy transfer =

\_\_\_\_\_ W





**0 4 . 3** The RTG has a constant output voltage of 32V.

Calculate the current when the output power is 100 W. [1 mark]

current = \_\_\_\_\_ A

**0 4 . 4** Calculate the maximum number of components, each of resistance 45  $\Omega$ , that can be connected in parallel across the RTG before the maximum output power is reached. [2 marks]

number of components = \_\_\_\_\_

[Turn over]



**0 4 . 5** The alternative to using an RTG is to use a solar panel.

A typical solar panel installation on a house roof in the UK provides about 1000 kW h of electricity each year.

Calculate the average electrical power output of the installation. [2 marks]

average power output = \_\_\_\_\_ W

**0 4 . 6** The maximum intensity of the sunlight on the surface of Mars at its equator is similar to that in the UK.

Estimate, using your answer to Question 4.5, the area of the solar panel needed to provide an average power output of 100 W on Mars. Give your answer to an appropriate order of magnitude. [1 mark]

order of magnitude of area = \_\_\_\_\_ m<sup>2</sup>

**END OF SECTION B**

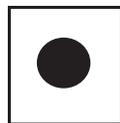


## SECTION C

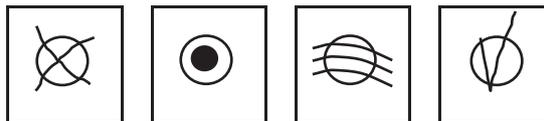
Each of Questions 5 to 34 is followed by four responses, A, B, C and D. For each question, select the best response.

Only ONE answer per question is allowed.  
For each answer completely fill in the circle alongside the appropriate answer.

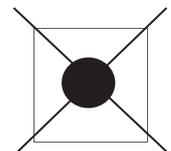
**CORRECT METHOD**



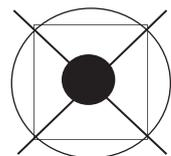
**WRONG METHODS**



If you want to change your answer you must cross out your original answer as shown.



If you wish to return to an answer previously crossed out, ring the answer you now wish to select as shown.



You may do your working out in the blank spaces around the questions but this will not be marked.

[Turn over]



- 0 5** A nucleus of a particular element decays, emitting a series of  $\alpha$  and  $\beta^-$  particles.

Which of the following series of emissions would result in an isotope of the original element? [1 mark]

A 1  $\alpha$  and 1  $\beta^-$

B 1  $\alpha$  and 2  $\beta^-$

C 2  $\alpha$  and 1  $\beta^-$

D 2  $\alpha$  and 2  $\beta^-$

- 0 6** Which equation shows the process of annihilation? [1 mark]

A  $\pi^- + \pi \rightarrow \gamma$

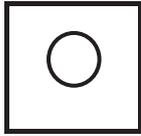
B  $p + \bar{p} \rightarrow \gamma + \gamma$

C  $\beta^- + p \rightarrow \gamma$

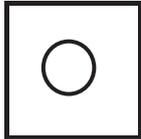
D  $\gamma + \gamma \rightarrow \beta^+ + \beta^-$



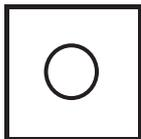
**0 7** Which of the following is NOT made of quarks?  
[1 mark]



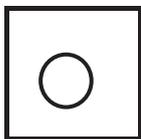
A kaon



B muon

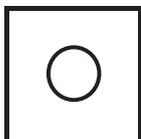


C neutron

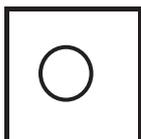


D pion

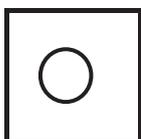
**0 8** What is the quark structure for antiprotons?  
[1 mark]



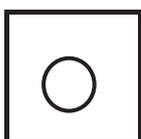
A  $\bar{u}\bar{d}$



B  $\bar{d}\bar{d}\bar{s}$



C  $\bar{d}\bar{d}\bar{u}$



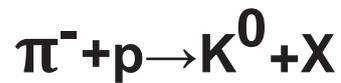
D  $\bar{u}\bar{u}\bar{d}$

[Turn over]



09

The equation represents the weak interaction between a negative pion and a proton.



What is the charge, baryon number and strangeness of particle X? [1 mark]





	Charge	Baryon number	Strangeness
<b>A</b>	<b>0</b>	<b>0</b>	<b>0</b>
<b>B</b>	<b>0</b>	<b>1</b>	<b>+1</b>
<b>C</b>	<b>1</b>	<b>1</b>	<b>0</b>
<b>D</b>	<b>0</b>	<b>1</b>	<b>-1</b>



1 0

The diagram gives some of the energy levels of a hydrogen atom. It is not drawn to scale.

	energy/ eV
$E_4$ -----	-0.54
$E_3$ -----	-0.85
$E_2$ -----	-1.51
$E_1$ -----	-3.39
$E_0$ -----	-13.6

The transition of an excited hydrogen atom from  $E_3$  to  $E_1$  causes a photon of visible light to be emitted.

Which transition causes a photon of ultraviolet light to be emitted? [1 mark]

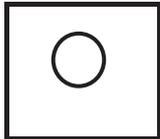
- A  $E_4$  to  $E_3$
- B  $E_3$  to  $E_2$
- C  $E_2$  to  $E_1$
- D  $E_1$  to  $E_0$

[Turn over]

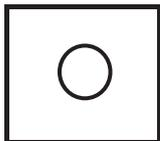


- 1 1** A proton moving with a speed  $v$  has a de Broglie wavelength  $\lambda$ .

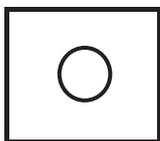
What is the de Broglie wavelength of an alpha particle moving at the same speed  $v$ ? [1 mark]



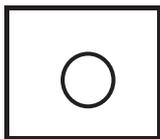
**A**  $\frac{\lambda}{4}$



**B**  $\lambda$



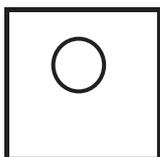
**C**  $2\lambda$



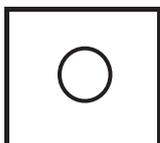
**D**  $4\lambda$

- 1 2** What is the phase difference between two points 0.16 m apart on a progressive sound wave of frequency 256 Hz? [1 mark]

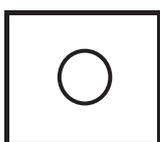
Speed of sound =  $330 \text{ m s}^{-1}$



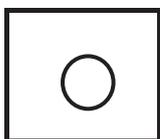
**A**  $\frac{\pi}{8}$



**B**  $\frac{\pi}{6}$



**C**  $\frac{\pi}{4}$



**D**  $\frac{\pi}{8}$





- 1 3** The frequency of the first harmonic of a standing wave on a wire is  $f$ . The length of the wire and tension in the wire are both doubled.

What is the frequency of the first harmonic as a result? [1 mark]

**A**  $\frac{f}{\sqrt{2}}$

**B**  $f$

**C**  $\sqrt{2}f$

**D**  $2f$

[Turn over]



- 1 4** In a diffraction-grating experiment the maxima are produced on a screen.

What causes the separation of the maxima of the diffraction pattern to decrease? [1 mark]

- A** using light with a longer wavelength
- B** increasing the distance between the screen and grating
- C** increasing the distance between the source and grating
- D** using a grating with a greater slit separation

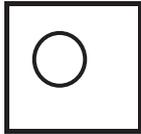
- 1 5** White light passes through a single narrow slit and illuminates a screen.

What is observed on the screen? [1 mark]

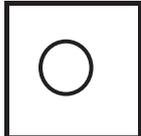
- A** a set of equally spaced white fringes
- B** a central maximum made up of a spectrum surrounded by white fringes
- C** a white central maximum surrounded by coloured fringes
- D** a single narrow white line



**1 6** Which of the following is correct when total internal reflection occurs? [1 mark]



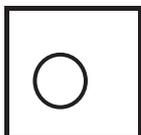
**A** The angle of incidence is less than the critical angle.



**B** The light meets an optically less dense medium.

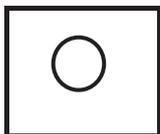


**C** The light enters a medium with a higher refractive index.



**D** The angles that the incident and refracted rays make with the normal are the same.

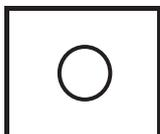
**1 7** What is the speed of light in glass of refractive index 1.42? [1 mark]



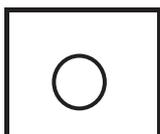
**A**  $4.26 \times 10^7 \text{ m s}^{-1}$



**B**  $2.11 \times 10^8 \text{ m s}^{-1}$



**C**  $3.00 \times 10^8 \text{ m s}^{-1}$



**D**  $4.73 \times 10^8 \text{ m s}^{-1}$

[Turn over]



**1 8** Which is a scalar quantity? [1 mark]

**A** momentum

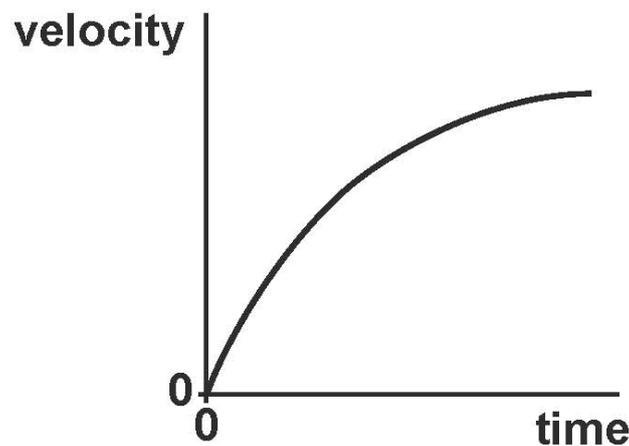
**B** weight

**C** power

**D** moment

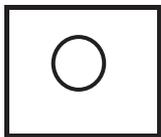
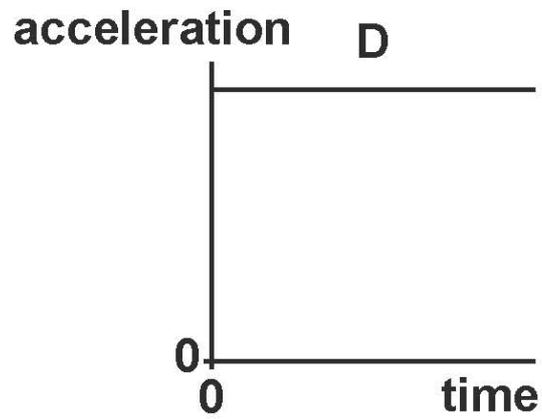
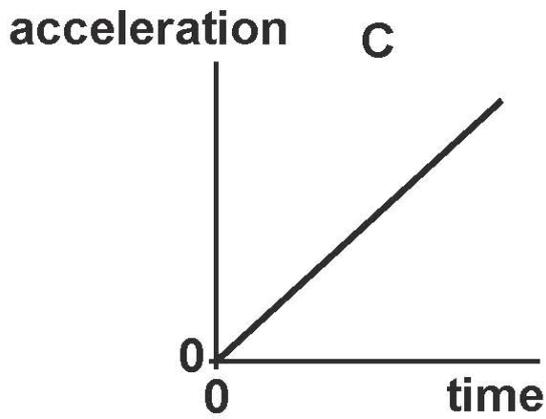
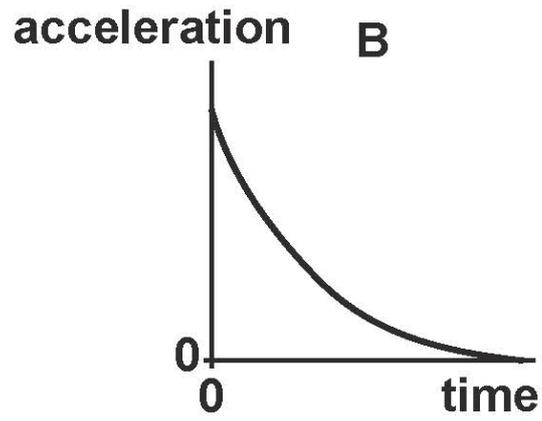
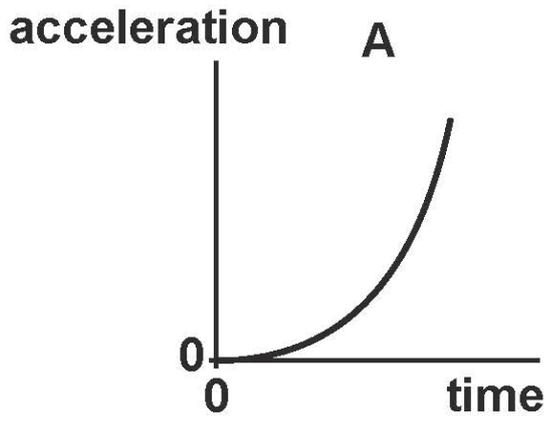
**1 9**

The velocity–time graph for a falling object is shown.

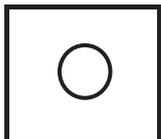


Which of the following shows the corresponding acceleration–time graph?  
[1 mark]

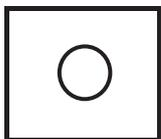




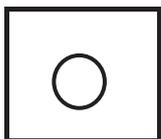
**A**



**B**



**C**



**D**

[Turn over]



20

A girl jogs at  $2.0 \text{ m s}^{-1}$  in a straight line for 30 seconds, turns around and returns to her starting point 20 seconds later.

What is her average velocity and average speed? [1 mark]

	Average velocity/ $\text{m s}^{-1}$	Average speed/ $\text{m s}^{-1}$
A	$0 \text{ m s}^{-1}$	$2.4 \text{ m s}^{-1}$
B	$0 \text{ m s}^{-1}$	$2.5 \text{ m s}^{-1}$
C	$1.0 \text{ m s}^{-1}$	$2.0 \text{ m s}^{-1}$
D	$2.5 \text{ m s}^{-1}$	$2.5 \text{ m s}^{-1}$

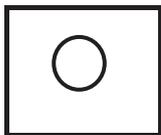


2	1
---	---

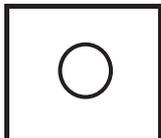
A golf ball was hit from the surface of the Moon. The time of flight was 4.0 s.

What is the best estimate for the maximum height reached by the ball? [1 mark]

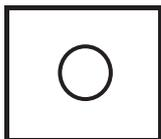
acceleration due to gravity on the Moon  
=  $1.6 \text{ m s}^{-2}$



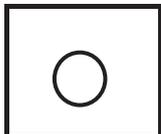
A 3m



B 15m



C 40m



D 80m

[Turn over]



2 2

A deep-space probe travelling forward at constant speed is briefly acted on by a force at right angles to its motion.

What is the effect of this force on the forward speed and sideways speed of this probe?  
[1 mark]

**A** Its forward speed increases and sideways speed increases.

**B** Its forward speed decreases and sideways speed increases.

**C** Its forward speed is unchanged and sideways speed increases.

**D** Its forward speed decreases and sideways speed is unchanged.





- 2 3** The mass of fuel in a racing car decreases during a race. As a result the lap time decreases.

Which of the following could explain this decrease? [1 mark]

**A** There is less friction on the race track.

**B** The maximum speed of the car has increased.

**C** The maximum acceleration and deceleration are greater.

**D** The engine is more efficient.

- 2 4** What is represented by the area under a force–displacement graph? [1 mark]

**A** rate of change of kinetic energy

**B** change in momentum

**C** work done

**D** acceleration

[Turn over]



**2 5** Which of the following is NOT a unit of power? [1 mark]

A  $\text{N m s}^{-1}$

B  $\text{J s}$

C  $\text{W}$

D  $\text{kg m}^2 \text{s}^{-3}$

**2 6** A roller coaster car is raised to a height of 65 m and released from rest.

What is the maximum possible speed of the car? [1 mark]

A  $11 \text{ m s}^{-1}$

B  $25 \text{ m s}^{-1}$

C  $36 \text{ m s}^{-1}$

D  $130 \text{ m s}^{-1}$



**2 7**

In a test a 500 kg car travelling at  $10 \text{ m s}^{-1}$  hits a wall. The front 0.30 m of the car crumples as the car is brought to rest.

What is the average force on the car during the impact? [1 mark]

**A 830 N****B 7500 N****C 8300 N****D 83 000 N**

[Turn over]



**2 8** The current in a wire is 20 mA.

How many electrons pass a point in the wire in 2 minutes? [1 mark]

A  $2.5 \times 10^{17}$

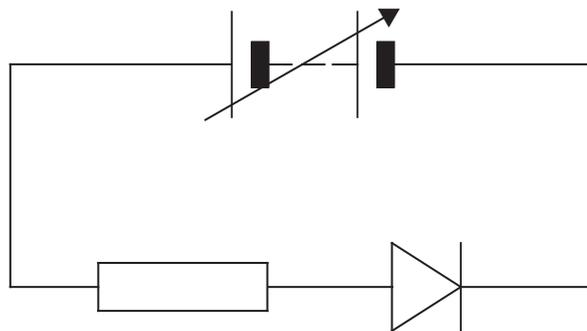
B  $1.5 \times 10^{19}$

C  $2.5 \times 10^{20}$

D  $1.5 \times 10^{22}$

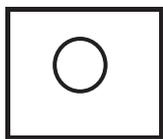
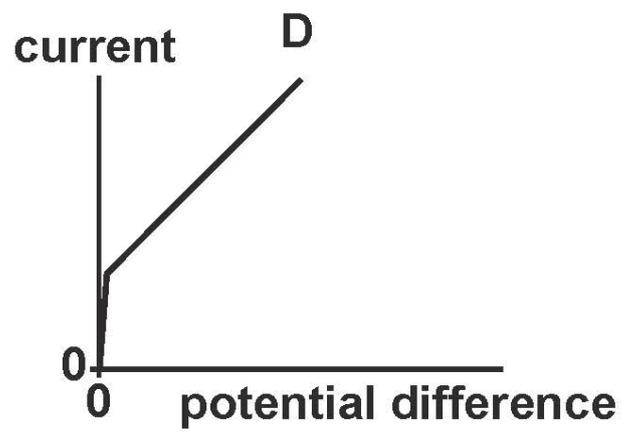
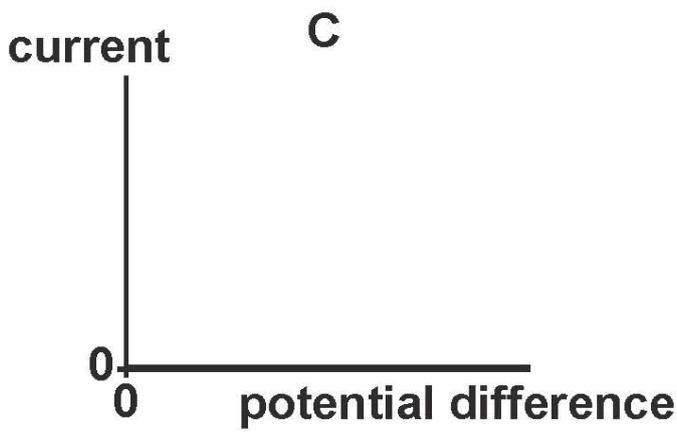
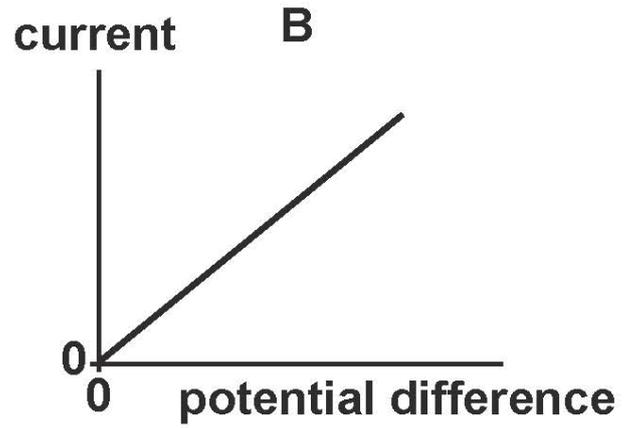
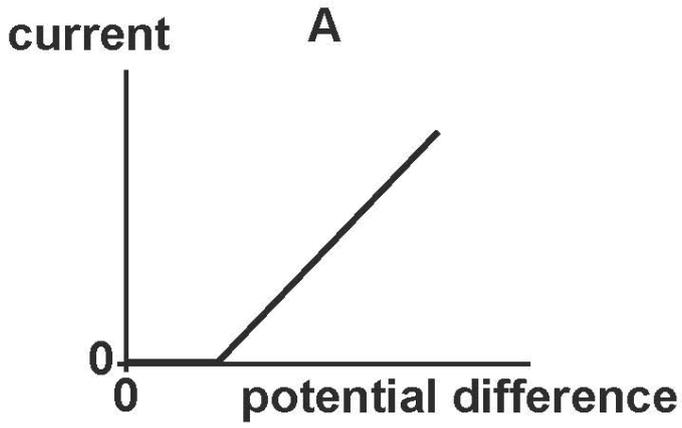
**2 9**

A resistor and diode are connected in series with a variable power supply as shown in the diagram.

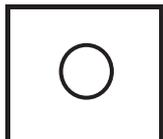


Which best shows the characteristic for the combination of the resistor and diode? [1 mark]

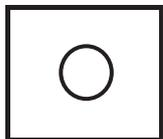




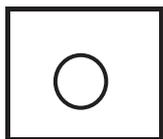
**A**



**B**



**C**



**D**

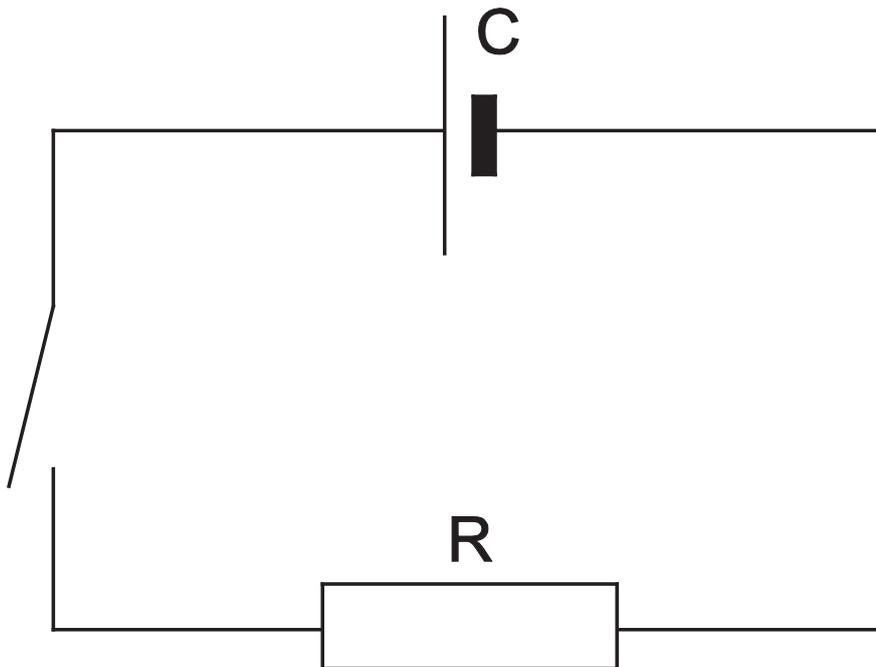
**[Turn over]**



3 0

A cell C of negligible resistance and a switch are in series with a resistor R. The switch is moved to the on (closed) position for a time  $t$ .

Which change reduces the amount of charge flowing through R in time  $t$ ? [1 mark]




A Add an identical cell in parallel with C.

B Add an identical cell in series with C.

C Add a second resistor in series with R.

D Add a second resistor in parallel with R.



**3 1**

The National Grid uses high-voltage transmission lines to carry electrical power around the UK. A particular transmission line delivers 800 MW of power at 132 kV to the user. It loses 1% of the transmitted power as heat.

What is the resistance of the transmission line? [1 mark]

**A 0.2  $\Omega$** **B 6  $\Omega$** **C 20  $\Omega$** **D 2000  $\Omega$** 

[Turn over]



3	2
---	---

A potential divider circuit consists of a battery connected across a thermistor and variable resistor in series.

Which of the following causes the potential difference (pd) across the thermistor to increase? [1 mark]

A increasing the temperature of the thermistor

B increasing the resistance of the variable resistor

C reducing the emf of the battery

D adding a resistor across the variable resistor





**BLANK PAGE**

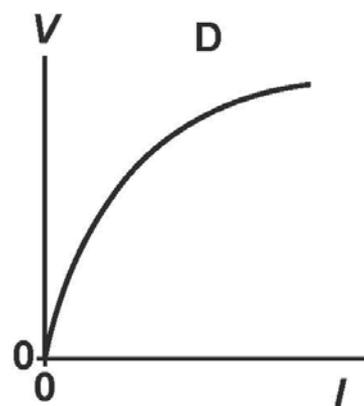
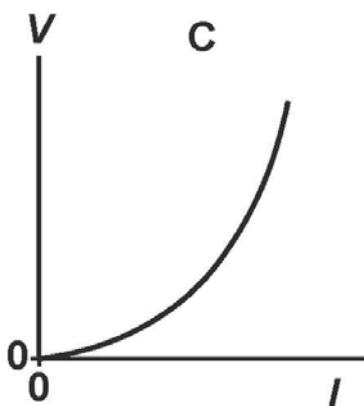
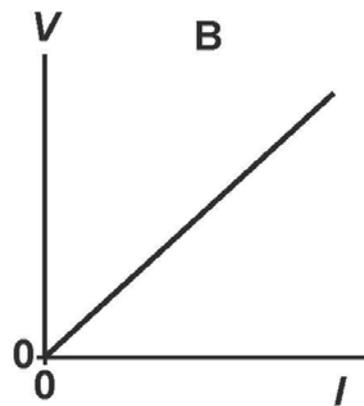
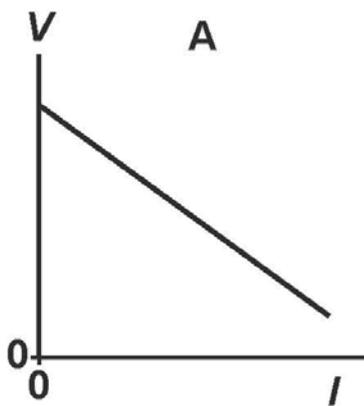
**[Turn over]**

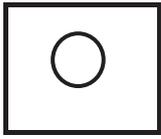


3 3

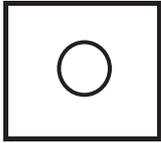
A student investigates how the potential difference  $V$  across the terminals of a cell varies with the current  $I$  in the cell.

Which graph correctly shows how  $V$  varies with  $I$ ? [1 mark]

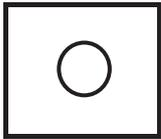




**A**



**B**



**C**



**D**

**[Turn over]**



**3 4**

A battery is connected to a  $10\ \Omega$  resistor and a switch in series. A voltmeter is connected across the battery. When the switch is open (off) the voltmeter reads  $1.45\ \text{V}$ . When the switch is closed the reading is  $1.26\ \text{V}$ .

What is the internal resistance of the battery?  
[1 mark]

**A**  $0.66\ \Omega$ **B**  $0.76\ \Omega$ **C**  $1.3\ \Omega$ **D**  $1.5\ \Omega$ **END OF QUESTIONS**

**There are no questions printed on this page**

**Copyright Information**

For confidentiality purposes, from the November 2015 examination series, acknowledgements of third party copyright material will be published in a separate booklet rather than including them on the examination paper or support materials. This booklet is published after each examination series and is available for free download from [www.aqa.org.uk](http://www.aqa.org.uk) after the live examination series.

Permission to reproduce all copyright material has been applied for. In some cases, efforts to contact copyright-holders may have been unsuccessful and AQA will be happy to rectify any omissions of acknowledgements. If you have any queries please contact the Copyright Team, AQA, Stag Hill House, Guildford, GU2 7XJ.

Copyright © 2016 AQA and its licensors. All rights reserved.

**IB/M/Jun16/7407/2/CD/E7**

