



Surname _____

Other Names _____

Centre Number _____

Candidate Number _____

Candidate Signature _____

AS BIOLOGY

Paper 1

7401/1

Thursday 24 May 2018

Afternoon

Time allowed: 1 hour 30 minutes

For this paper you must have:

- a ruler with millimetre measurements
- a scientific calculator.

At the top of the page, write your surname and other names, your centre number, your candidate number and add your signature.

[Turn over]



BLANK PAGE

INSTRUCTIONS

- **Use black ink or black ball-point pen.**
- **Answer ALL questions.**
- **You must answer the questions in the spaces provided. Do not write on blank pages.**
- **Show all your working.**
- **Do all rough work in this book. Cross through any work you do not want to be marked.**

INFORMATION

- **The marks for the questions are shown in brackets.**
- **The maximum mark for this paper is 75.**

DO NOT TURN OVER UNTIL TOLD TO DO SO

Answer ALL questions in the spaces provided.

01.1 FIGURE 1 shows part of the blood circulation in a mammal.

FIGURE 1

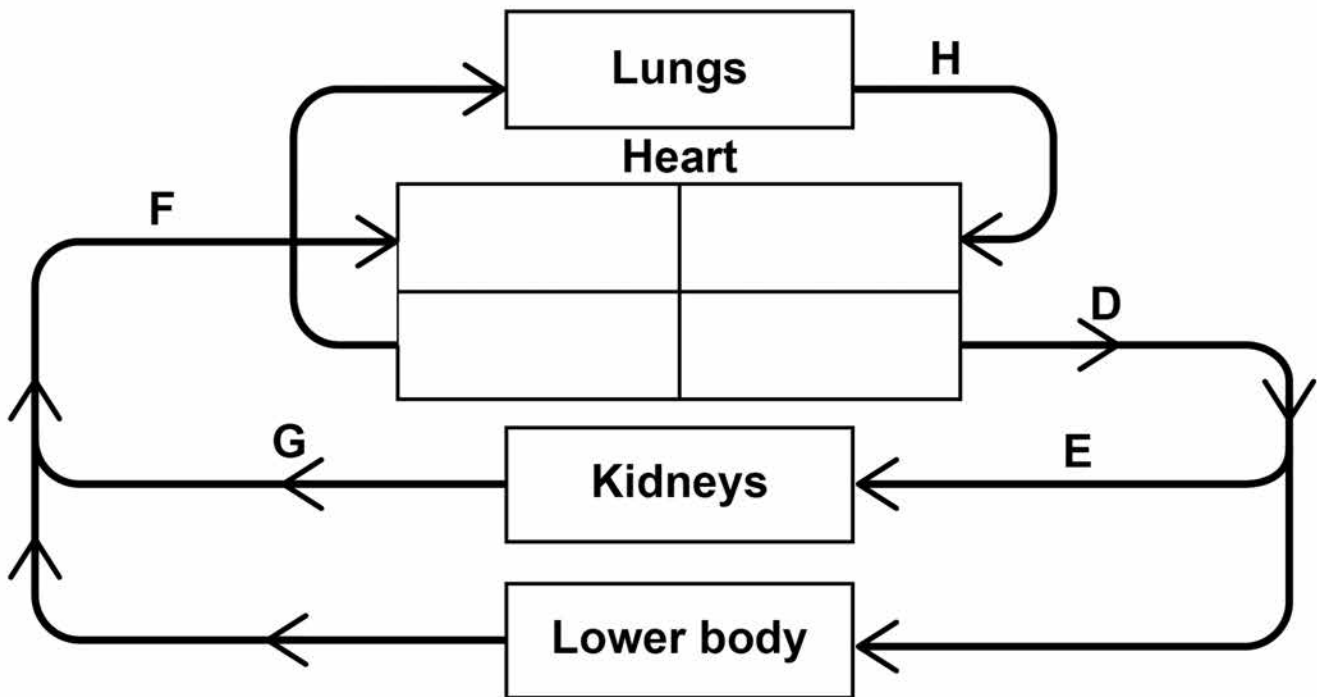

Use FIGURE 1 to give the letter that represents each of these blood vessels. [3 marks]

Aorta

Renal vein

Vena cava



0 1 . 2 Name the blood vessels that carry blood to the heart MUSCLE. [1 mark]

[Turn over]



- 01.3** FIGURE 2 shows a photograph of part of a mitochondrion from a mouse liver cell taken using a transmission electron microscope at $\times 62\,800$ magnification.

FIGURE 2

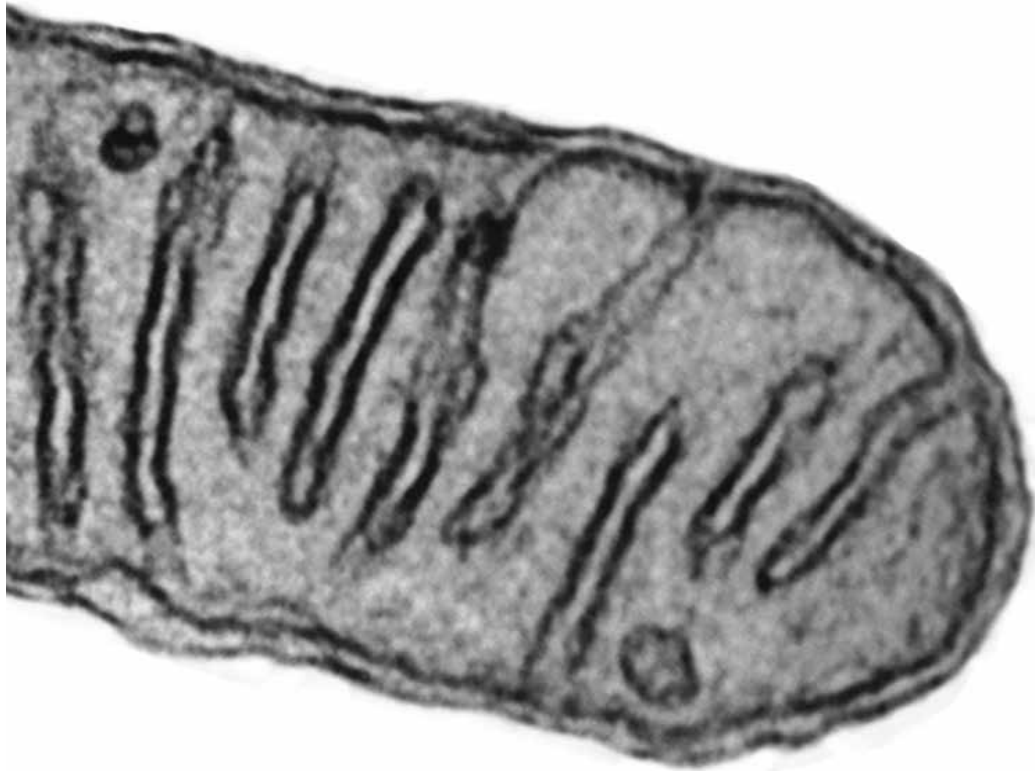

Produce a scientific drawing of the mitochondrion in FIGURE 2 in the box on the opposite page.

Label the following parts of the mitochondrion on your drawing.

- **Matrix**
- **Crista**

[4 marks]



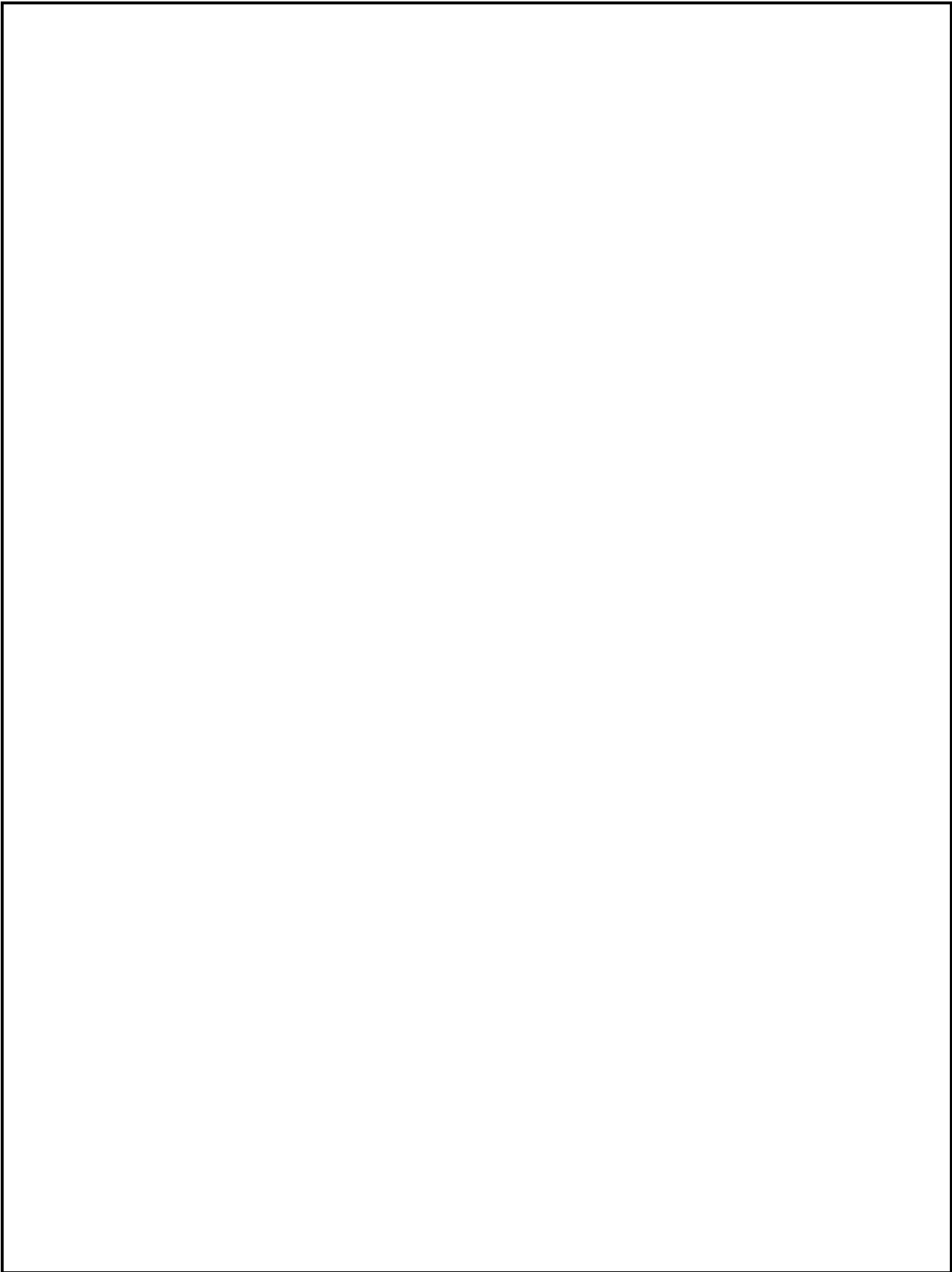

8

[Turn over]



0 2 . 1 What is a monomer? [1 mark]

0 2 . 2 Lactulose is a disaccharide formed from one molecule of galactose and one molecule of fructose.

Other than both being disaccharides, give ONE similarity and ONE difference between the structures of lactulose and lactose. [2 marks]

Similarity _____



Difference

[Turn over]



[Turn over]



02.4 Lactulose can also be used to treat people who have too high a concentration of hydrogen ions (H^+) in their blood.

The normal range for blood H^+ concentration is 3.55×10^{-8} to $4.47 \times 10^{-8} \text{ mol dm}^{-3}$

A patient was found to have a blood H^+ concentration of $2.82 \times 10^{-7} \text{ mol dm}^{-3}$

Calculate the minimum percentage decrease required to bring the patient's blood H^+ concentration into the normal range. [2 marks]

Answer = _____

7



03. 1 Draw AND label a single DNA nucleotide.
[2 marks]

[Turn over]



03.2 Give TWO features of DNA AND explain how each one is important in the semi-conservative replication of DNA. [2 marks]

1

2



03.3 Replication of mitochondrial DNA (mtDNA) is different from that of nuclear DNA.

The replication of the second strand of mtDNA **ONLY** starts after two-thirds of the first strand of mtDNA has been copied.

A piece of mtDNA is 16 500 base pairs long and is replicated at a rate of 50 nucleotides per second.

Tick (✓) the box that shows how long it would take to copy this mtDNA. [1 mark]

A 330 seconds

B 440 seconds

C 550 seconds

D 660 seconds

<hr/>
5

[Turn over]



04

FIGURE 3 shows part of a prokaryotic cell.

FIGURE 3

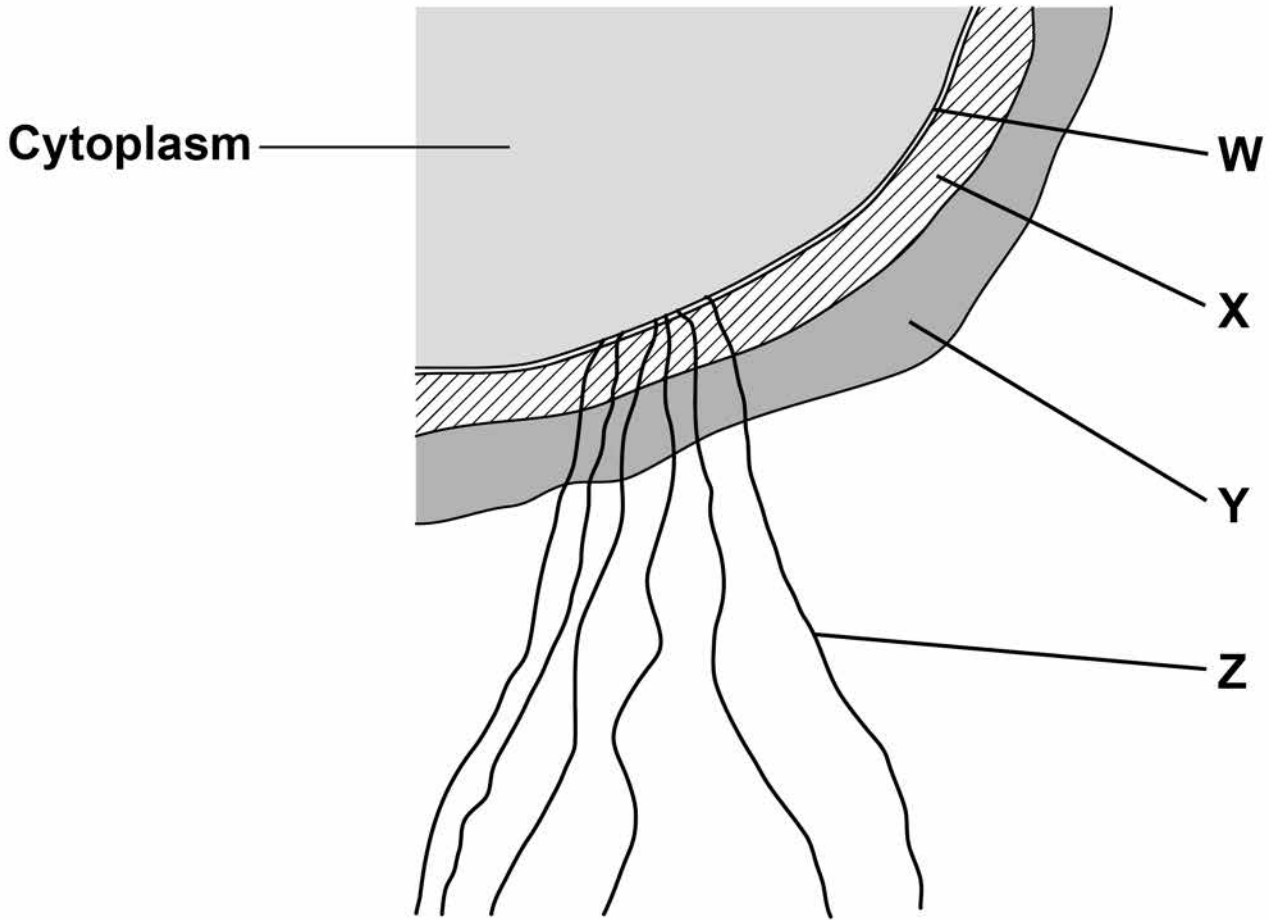

0 4 . 1 Name the structures labelled W to Z in **FIGURE 3. [2 marks]**

W _____

X _____

Y _____

Z _____

0 4 . 2 Name the main biological molecule in:

W _____

X _____

[2 marks]

[Turn over]



04.3 Name the process by which prokaryotic cells divide. [1 mark]



0 4 . 4 Some prokaryotic cells can divide every 30 minutes. A liquid culture contained a starting population of 1.35×10^4 cells.

Assuming each cell divides every 30 minutes, calculate how many cells there will be after 3 hours. Assume no cells die during this time.
[2 marks]

Answer = _____

7

[Turn over]



0 5 FIGURE 4 represents a triglyceride.

FIGURE 4

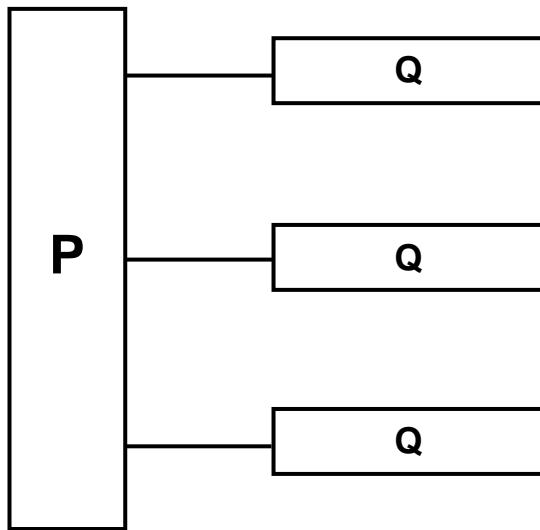

0 5 . 1 Name the molecules represented in FIGURE 4 by:

Box P _____

Box Q _____

[2 marks]

0 5 . 2 Name the type of bond between P and Q in FIGURE 4. [1 mark]



06

FIGURE 5 represents the phylogenetic classification of FOUR different species of fruit fly.

FIGURE 5

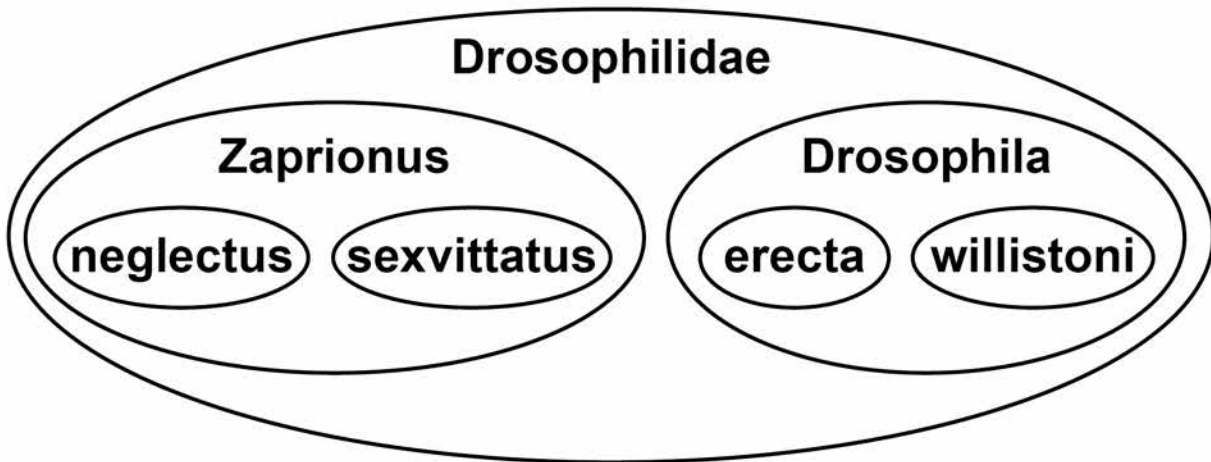

06.1

FIGURE 5 shows a hierarchy. Explain how. [2 marks]



06.2 Name the taxon to which *Drosophilidae* belongs. [1 mark]

[Turn over]



‘Drosophila’ fruit flies display courtship behaviour. One of the stages of courtship is singing by males. Normally a male will produce a ‘sine song’, in which continual noise is made, and a ‘pulse song’, in which there is continual noise with some louder peaks.

Scientists showed fruit flies a visual stimulus that made them sing. They made recordings of these songs.

FIGURE 6 shows the recordings of the songs of three flies over the same time period.



FIGURE 6

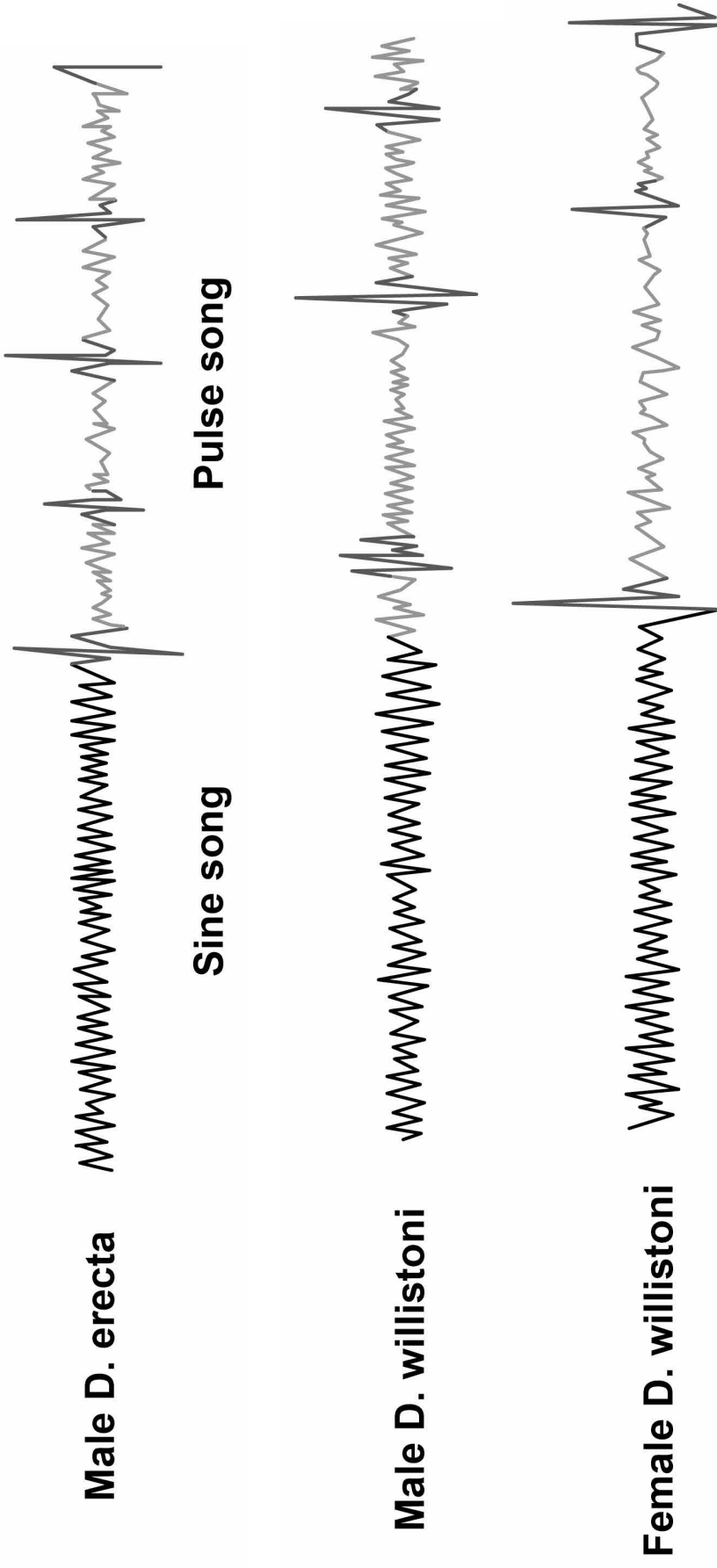

[Turn over]



06.3 'D. erecta' and 'D. willistoni' are closely related species BUT different species.

Describe evidence from FIGURE 6, on page 25, that supports this statement. [2 marks]



[Turn over]



06 . 4 The scientists repeated their experiments, using female fruit flies as the visual stimulus. When a male and female 'D. willistoni' were together, their songs led to mating.

When two female 'D.willistoni' were together, their songs did NOT lead to any attempt to mate.

Use information from FIGURE 6 to suggest why the two females did not attempt to mate. [2 marks]



[Turn over]



07.1 What is the proteome of a cell? [1 mark]

07.2 Give TWO structural differences between a molecule of messenger RNA (mRNA) and a molecule of transfer RNA (tRNA). [2 marks]

1



2

[Turn over]



08.2 Water is used to hydrolyse ATP.

**Name the TWO products of ATP hydrolysis.
[1 mark]**

1 _____

2 _____

[Turn over]



Hydrolysis of ATP is catalysed by the enzyme ATP hydrolase.

A student investigated the effect of ATP concentration on the activity of ATP hydrolase. She used shortening of strips of muscle tissue caused by contraction as evidence that ATP was being hydrolysed.

- She took four slides A, B, C and D, and added strips of muscle tissue of the same length to each slide.
- She then added the same volume of ATP solutions of different concentrations to the four slides and left each slide for five minutes.
- She then recorded the final length of each strip of muscle tissue.

Her results can be seen in TABLE 1.

TABLE 1

Slide	Concentration of ATP solution added to slide / $\times 10^{-6} \text{ mol dm}^{-3}$	Final length of muscle tissue after 5 minutes / mm
A	2	36
B	4	31
C	6	29
D	8	26



08.3 Other than those given, name TWO variables the student should have controlled. [2 marks]

1 _____

2 _____

[Turn over]



BLANK PAGE



0 8 . 4 Describe AND explain the pattern shown by the data in TABLE 1. [2 marks]

Description _____

Explanation _____

[Turn over]



08.5 The hydrolysis of 1 dm^3 of a 1 mol dm^{-3} solution of ATP releases $30\,500 \text{ J}$ of energy.

60% of the energy released during the hydrolysis of 1 mol dm^{-3} of ATP is released as heat; the rest is used for muscle contraction.

The student added 0.05 cm^3 of ATP solution to slide D.

Calculate the energy available from ATP for contraction of the muscle on this slide.
[3 marks]

Answer = _____ J

10



Carbon monoxide is a poisonous gas that is present in cigarette smoke. This carbon monoxide can be absorbed into the blood where it binds with haemoglobin.

Scientists investigated the concentration of carbon monoxide in cars in which people were smoking or not smoking. They measured the concentration with the car windows open and closed. FIGURE 7, on page 44, shows the scientists' results as they presented them. A value of ± 2 standard deviations from the mean includes over 95% of the data.

09 . 3 In England, in October 2015, a law was introduced making it illegal to smoke in a car carrying someone who is under the age of 18.

Following the introduction of the law, a politician stated:

'It is dangerous to smoke when a child is in the car. Higher levels of deadly toxins can build up, even on short journeys, and children breathe faster than adults, meaning they inhale more of the deadly toxins.'

[Turn over]



FIGURE 7

Mean concentration
of carbon monoxide
in the air inside the
car / parts per
million

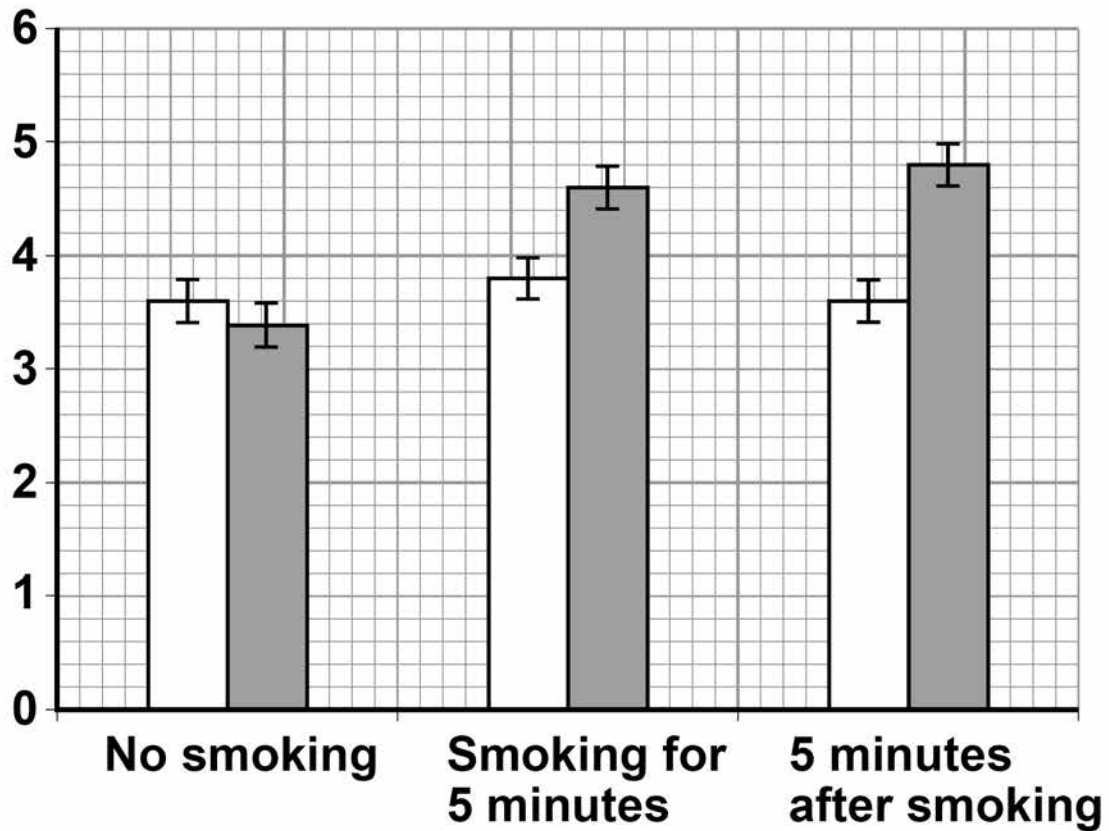
**KEY**

□ Open window

■ Closed window

I ± 2 SD



BLANK PAGE

[Turn over]



1	0
---	---

Read the following passage.

Sizes of populations of normal intestinal bacteria are usually controlled by T cells that are produced slowly and in small numbers by the immune system. These T cells do not normally survive for very long. As a result, they do not release large amounts of cytokines. Cytokines are chemicals that can cause swelling of the lining of the intestines. 5

Crohn's disease is a long-lasting disease that causes swelling of the lining of the intestines. It is believed that Crohn's disease can be caused by a loss of tolerance to normal intestinal bacteria, as shown by an unusually large response by T cells. This response can be triggered by pathogenic bacteria in the intestines of people with a genetic tendency to Crohn's disease. 10 15

Some people's Crohn's disease can be controlled by a drug called 5-aminosalicylic acid (5-ASA) that reduces swelling. Another drug called 6-mercaptopurine (6-MP) may also be used. 6-MP inhibits an enzyme required to make adenine and guanine. This is effective because most cells can recycle nucleotides, but T cells are not able to do so. 20 25

Use information from the passage and your own knowledge to answer the questions.



There are no questions printed on this page



There are no questions printed on this page

For Examiner's Use	
Question	Mark
1	
2	
3	
4	
5	
6	
7	
8	
9	
10	
TOTAL	

Copyright information

For confidentiality purposes, from the November 2015 examination series, acknowledgements of third party copyright material will be published in a separate booklet rather than including them on the examination paper or support materials. This booklet is published after each examination series and is available for free download from www.aqa.org.uk after the live examination series.

Permission to reproduce all copyright material has been applied for. In some cases, efforts to contact copyright-holders may have been unsuccessful and AQA will be happy to rectify any omissions of acknowledgements. If you have any queries please contact the Copyright Team, AQA, Stag Hill House, Guildford, GU2 7XJ.

Copyright © 2018 AQA and its licensors. All rights reserved.

IB/M/Jun18/CD/7401/1/E4

