

A



Surname _____

Other Names _____

Centre Number _____

Candidate Number _____

Candidate Signature _____

GCSE

PHYSICS

Foundation Tier Paper 1

8463/1F

F

Wednesday 23 May 2018 Afternoon

Time allowed: 1 hour 45 minutes

At the top of the page, write your surname and other names, your centre number, your candidate number and add your signature.

[Turn over]



JUN1884631F01

For this paper you must have:

- **a ruler**
- **a scientific calculator**
- **the Physics Equations Sheet (enclosed).**

INSTRUCTIONS

- **Use black ink or black ball-point pen.**
- **Answer ALL questions in the spaces provided.**
- **Do all rough work in this book. Cross through any work you do not want to be marked.**
- **In all calculations, show clearly how you work out your answer.**



INFORMATION

- **The maximum mark for this paper is 100.**
- **The marks for questions are shown in brackets.**
- **You are expected to use a calculator where appropriate.**
- **You are reminded of the need for good English and clear presentation in your answers.**

**DO NOT TURN OVER UNTIL TOLD
TO DO SO**



4

0	1
---	---

FIGURE 1 shows a cyclist riding along a flat road.

FIGURE 1



0	1	.	1
---	---	---	---

Complete the sentence.

Choose answers from the list.
[2 marks]

chemical

elastic potential

gravitational potential

kinetic



5

**As the cyclist accelerates, the
_____ energy
store in the cyclist's body
decreases and the
_____ energy
of the cyclist increases.**

[Turn over]



BLANK PAGE



7

0 1 . 2 The mass of the cyclist is 80 kg. The speed of the cyclist is 12 m/s.

Calculate the kinetic energy of the cyclist.

Use the equation:

**kinetic energy =
 $0.5 \times \text{mass} \times (\text{speed})^2$
[2 marks]**

Kinetic energy = _____ J

[Turn over]



8

0 1 . 3 When the cyclist uses the brakes, the bicycle slows down.

This causes the temperature of the brake pads to increase by 50 °C.

The mass of the brake pads is 0.040 kg.

The specific heat capacity of the material of the brake pads is 480 J/kg °C.

Calculate the change in thermal energy of the brake pads.

Use the equation:

**change in thermal energy =
mass × specific heat capacity
× temperature change
[2 marks]**



9

Change in thermal energy =
_____ **J**

[Turn over]



BLANK PAGE



11

0 1 . 4 How is the internal energy of the particles in the brake pads affected by the increase in temperature?

Tick ONE box. [1 mark]

Decreased

Increased

Not affected

[Turn over]

7



12

0 2

FIGURE 2 shows how the current through a filament lamp changes after the lamp is switched on.

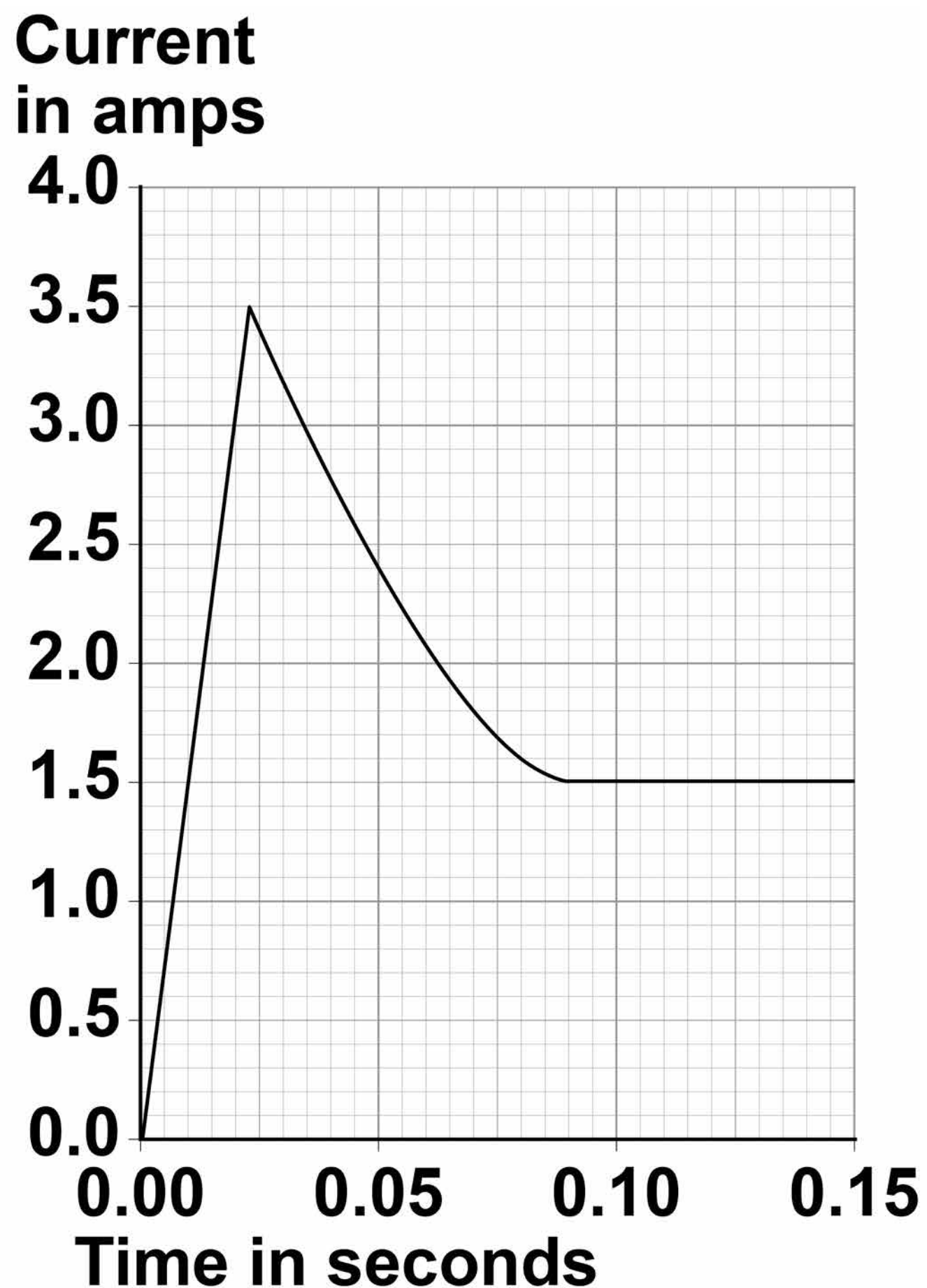
FIGURE 2

13

0 2 . 1 The normal current through the filament lamp is 1.5 A.

For how many seconds is the current through the filament lamp greater than 1.5 A?

Tick ONE box. [1 mark]

0.01 s

0.08 s

0.09 s

0.14 s

[Turn over]



0 2 . 2 Why might the filament inside a lamp melt when the lamp is first switched on? [1 mark]



15

0 2 . 3 The lamp is connected to a 24 V power supply. The current through the lamp is 1.5 A.

Calculate the power of the lamp.

Use the equation:

**power =
potential difference × current
[2 marks]**

Power = _____ W

[Turn over]



16

0 2 . 4 LED lamps are much more efficient than filament lamps.

What does this statement mean?

Tick ONE box. [1 mark]

LED lamps have a similar power output to filament lamps.

LED lamps waste a smaller proportion of the input energy than filament lamps.

LED lamps have a higher power input than filament lamps.

LED lamps waste a larger proportion of the input energy than filament lamps.

5



17

03.1 Draw a diagram to show how 1.5 V cells should be connected together to give a potential difference of 4.5 V.

Use the correct circuit symbol for a cell. [2 marks]

[Turn over]



18

A student built the circuit shown in FIGURE 3.

FIGURE 3

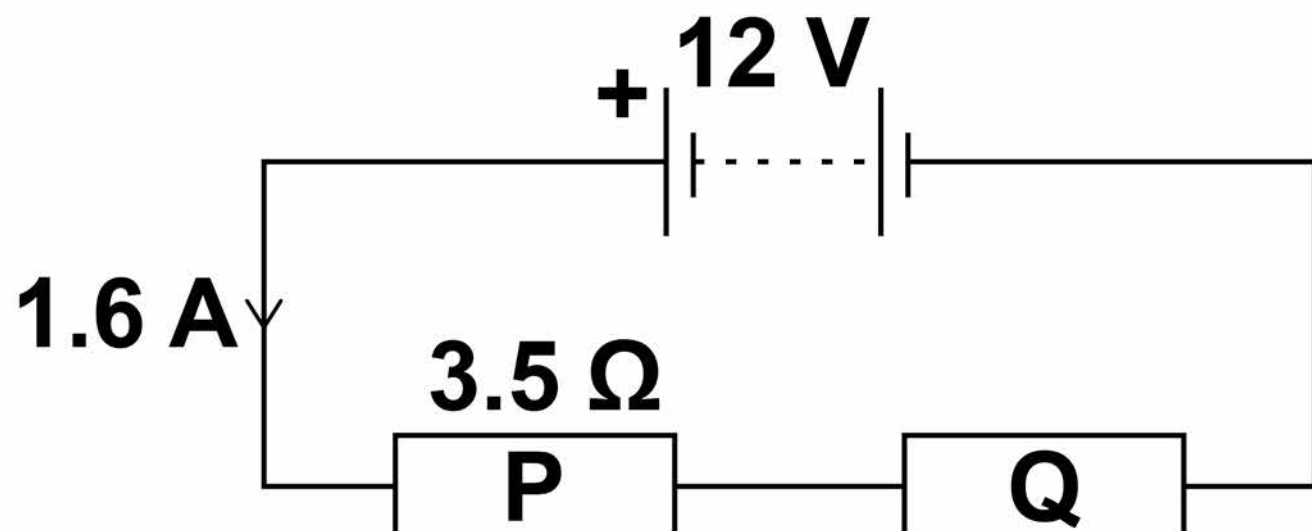

- 0 3 . 2** Calculate the total resistance of the circuit in FIGURE 3.
[2 marks]

Use the equation:

$$\text{resistance} = \frac{\text{potential difference}}{\text{current}}$$

Total resistance = _____ Ω

[Turn over]

BLANK PAGE



21

0 3 . 3 The resistance of P is 3.5 Ω .

**Calculate the resistance of Q.
[1 mark]**

Resistance of Q =

Ω

[Turn over]



0 3 . 4 The student connects the two resistors in FIGURE 3, on page 18, in parallel.

What happens to the total resistance of the circuit?

Tick ONE box. [1 mark]

It decreases

It increases

It does not change



23

Give a reason for your answer. [1 mark]

7

[Turn over]

0 4

A student wanted to determine the density of a small piece of rock.

0 4 . 1

Describe how the student could measure the volume of the piece of rock. [4 marks]



25

[Turn over]



26

0 4 . 2 The volume of the piece of rock was 18.0 cm^3 .

The student measured the mass of the piece of rock as 48.6 g .

Calculate the density of the rock in g/cm^3 .

Use the equation:

$$\text{density} = \frac{\text{mass}}{\text{volume}}$$

[2 marks]

Density = _____ g/cm^3



BLANK PAGE

[Turn over]



28

FIGURE 4 shows the densities of different types of rock.

FIGURE 4

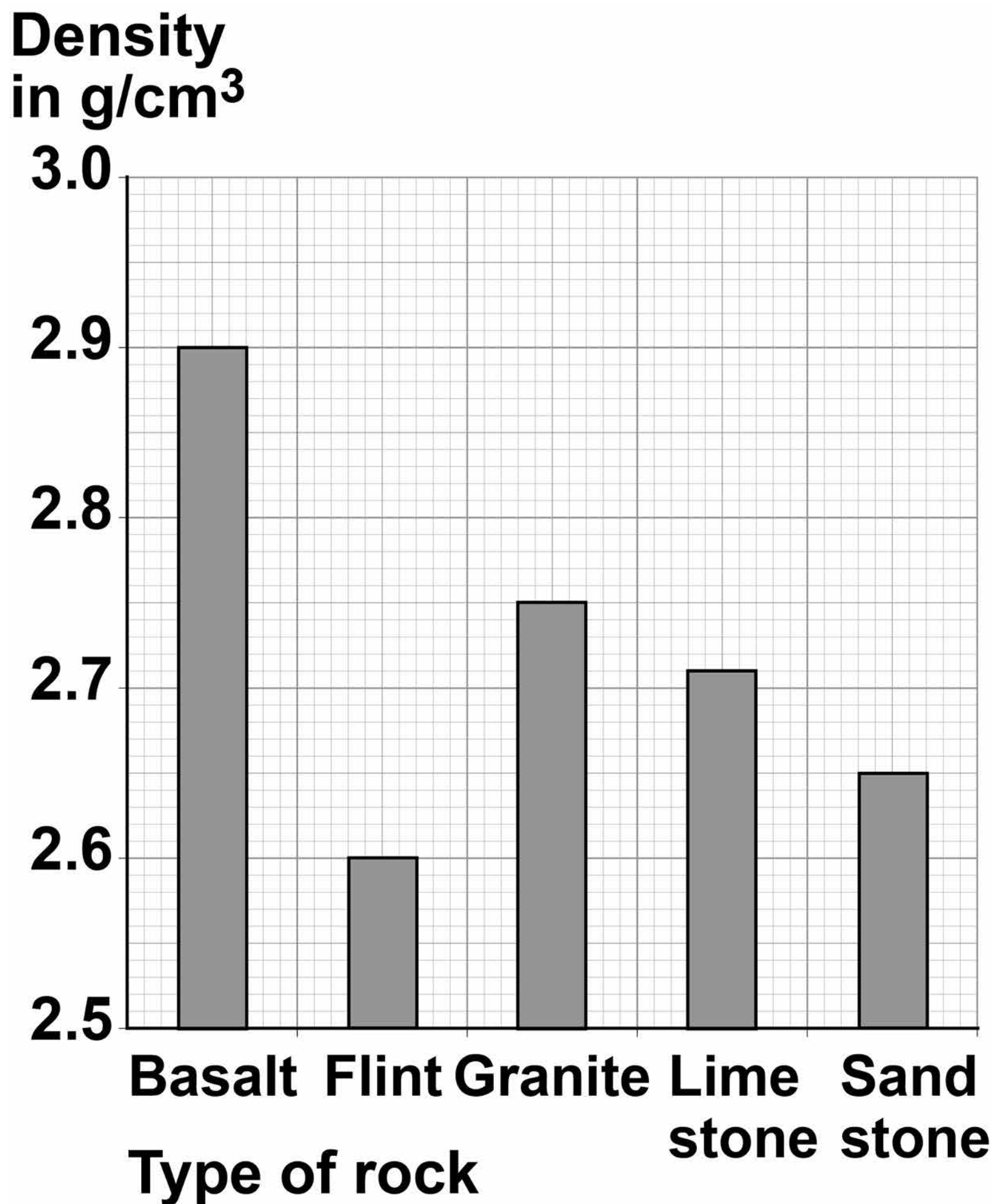

29

0 4 . 3 What is the most likely type of rock that the student had?

Tick ONE box. [1 mark]

Basalt

Flint

Granite

Limestone

Sandstone

[Turn over]



BLANK PAGE



31

0 4 . 4 Give ONE source of error that may have occurred when the student measured the volume of the rock. [1 mark]

0 4 . 5 How would the error you described in question 04.4 affect the measured volume of the rock? [1 mark]

9

[Turn over]



0 5

Americium-241 (${}_{95}^{241}\text{Am}$) is an isotope of americium.

0 5 . 1

Which of the isotopes given in TABLE 1 is NOT an isotope of americium? [2 marks]

TABLE 1

Isotope	Mass number	Atomic number
A	243	95
B	243	94
C	242	95

Isotope _____



33

Give a reason for your answer.

[Turn over]

FIGURE 5 shows how the number of americium-241 nuclei in a sample changes with time.

FIGURE 5

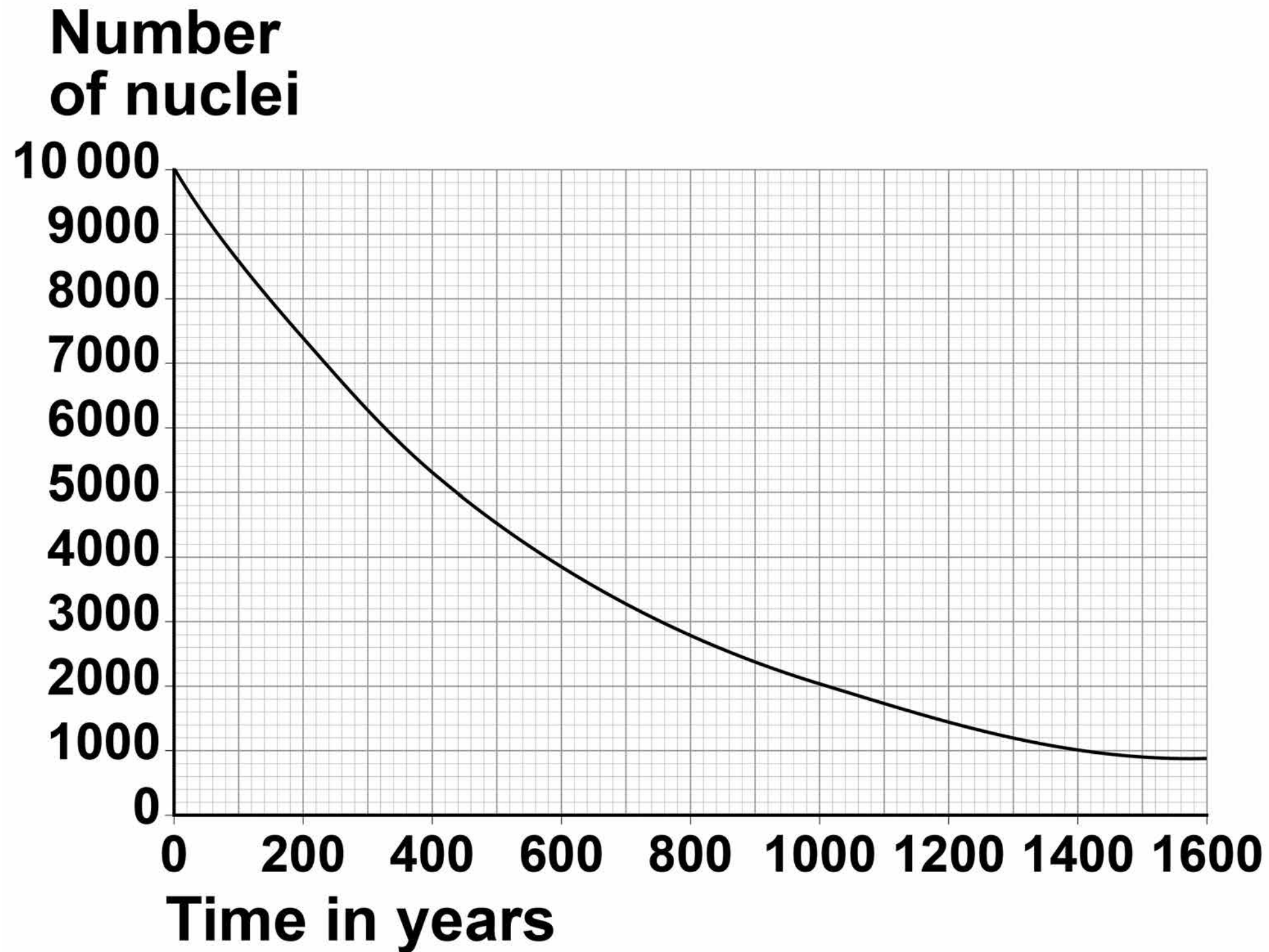

0 5 . 2 How many years does it take for the number of americium-241 nuclei to decrease from 10 000 to 5000? [1 mark]

Time = _____ years

0 5 . 3 What is the half-life of americium-241? [1 mark]

35

Half-life = _____ years

[Turn over]

4



0	6
---	---

Nuclear power can be used to generate electricity through nuclear fission.

FIGURE 6 shows the process of nuclear fission.

FIGURE 6

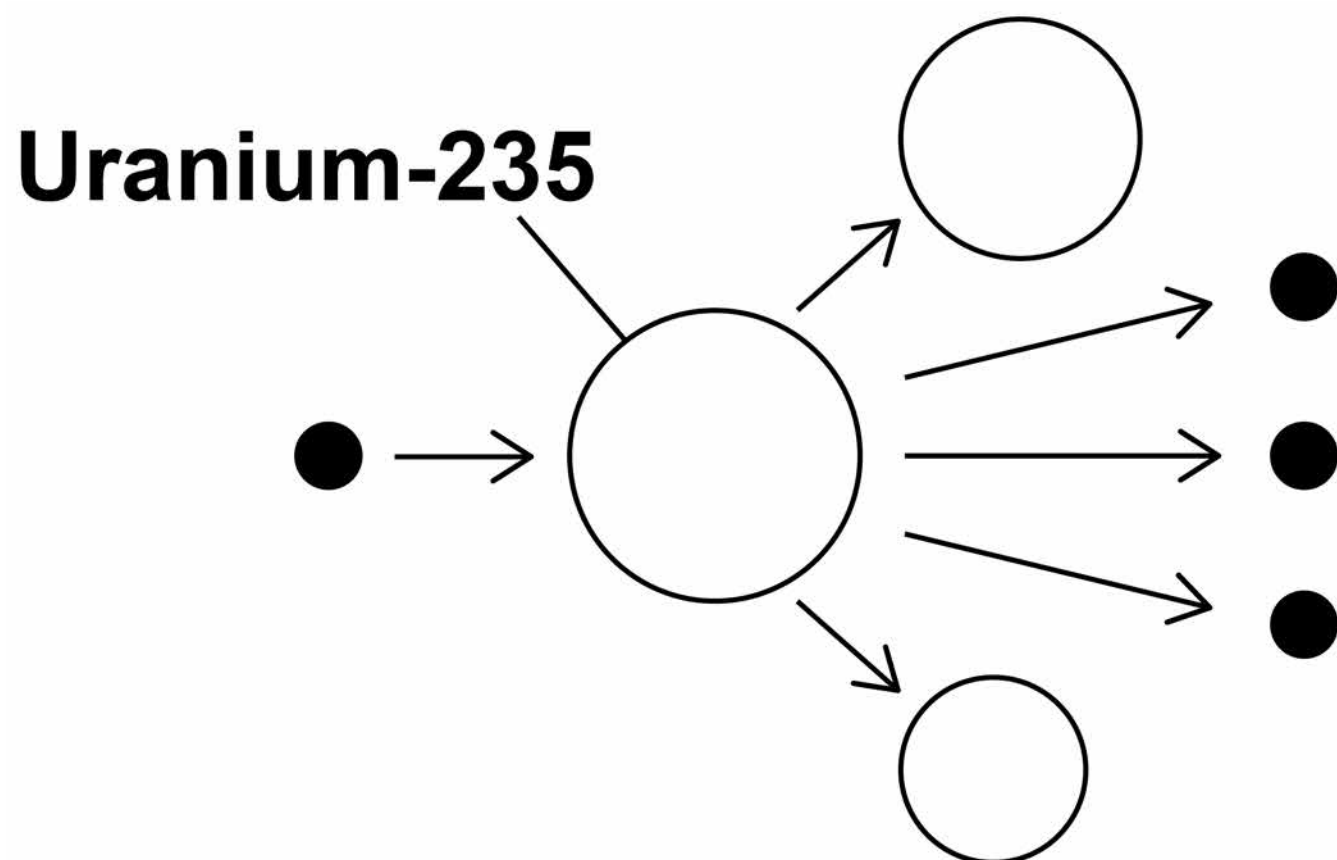

37

0 6 . 1 Complete the sentences.

**Choose answers from the list.
[3 marks]**

gamma rays

light rays

proton

neutron

nucleus

X-rays

**During the process of nuclear
fission a uranium _____
absorbs a _____.**

**Electromagnetic radiation is
released in the form of
_____.**

[Turn over]



38

0 6 . 2 The UK needs at least
25 000 000 kW of electrical
power at any time.

A nuclear power station has
an electrical power output of
2 400 000 kW

Calculate how many nuclear
power stations are needed to
provide 25 000 000 kW of
electrical power. [2 marks]

Number of nuclear power
stations = _____



0 6 . 3 State TWO environmental issues caused by generating electricity using nuclear power stations. [2 marks]

1

2

[Turn over]



06.4 The UK currently generates a lot of electricity by burning natural gas. This process releases carbon dioxide into the atmosphere.

FIGURE 7, on the opposite page, shows how the concentration of carbon dioxide in the atmosphere has changed over the past 115 years.



FIGURE 7

Carbon dioxide concentration in arbitrary units

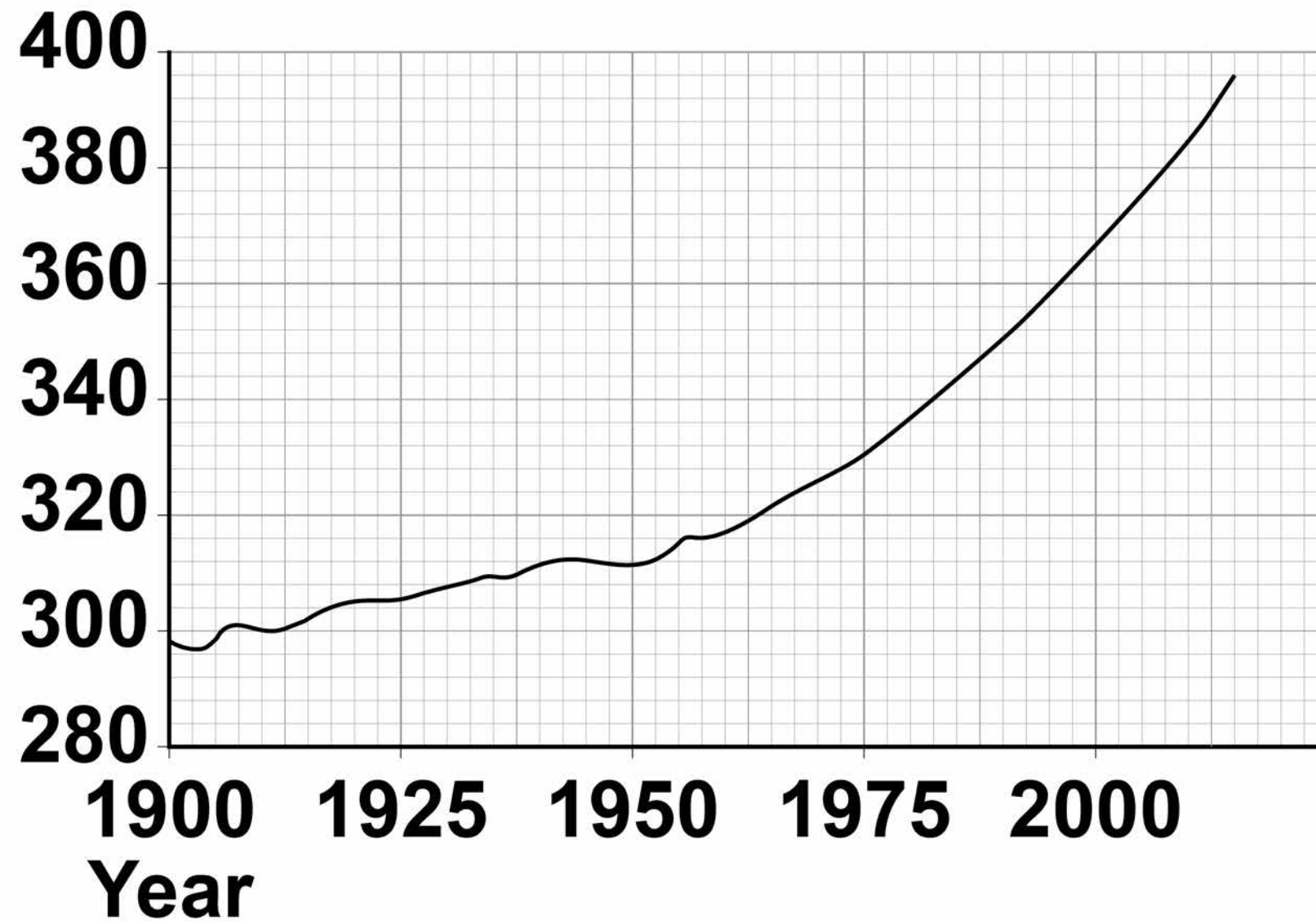

[Turn over]



FIGURE 8 shows how the global temperature has changed over the past 115 years.

FIGURE 8

**Global
temperature
increase
in °C**

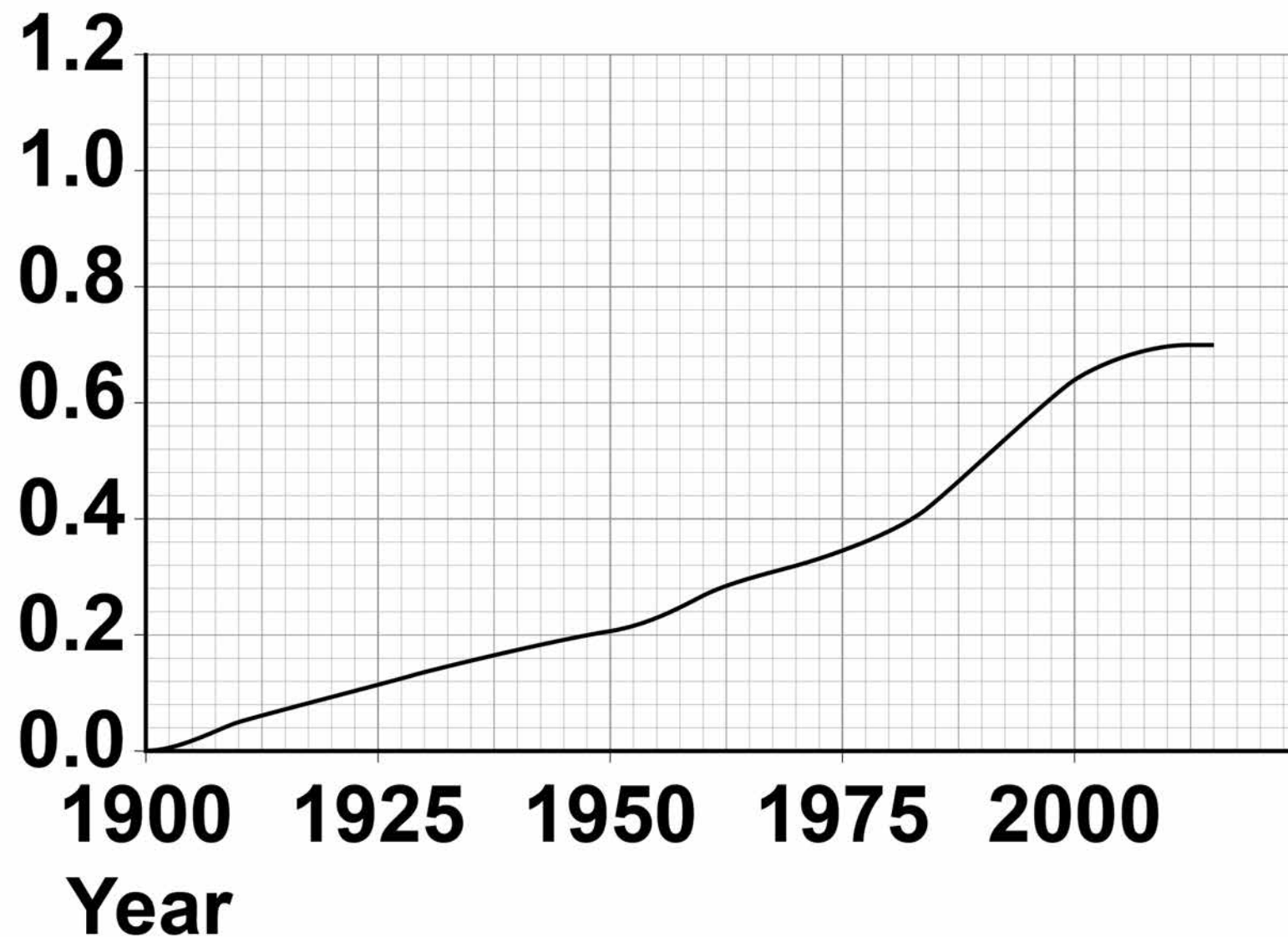

Give ONE similarity and ONE difference between the data in FIGURE 7, on page 41, and FIGURE 8, on page 42. [2 marks]

Similarity _____

Difference _____

43

9

[Turn over]



0	7
---	---

The plug of an electrical appliance contains a fuse.

0	7	.	1
---	---	---	---

What is the correct circuit symbol for a fuse?

Tick ONE box. [1 mark]

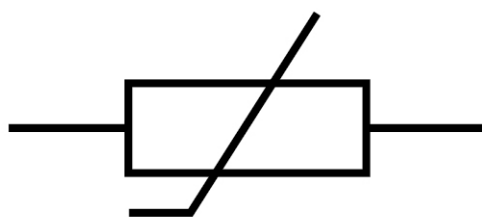
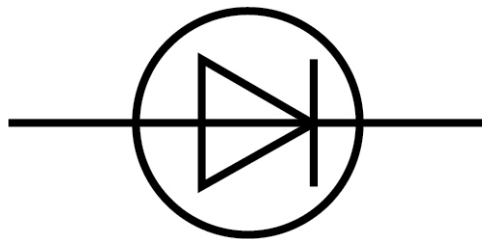
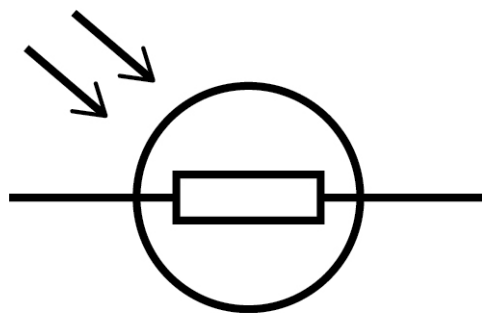

45

07.2 The appliance is connected to the mains electrical supply. The mains potential difference is 230 V.

Calculate the energy transferred when 13 C of charge flows through the appliance. [2 marks]

Use the equation:

energy transferred =
charge flow ×
potential difference

Energy transferred =

J

[Turn over]



46

FIGURE 9 shows the structure of a fuse.

FIGURE 9

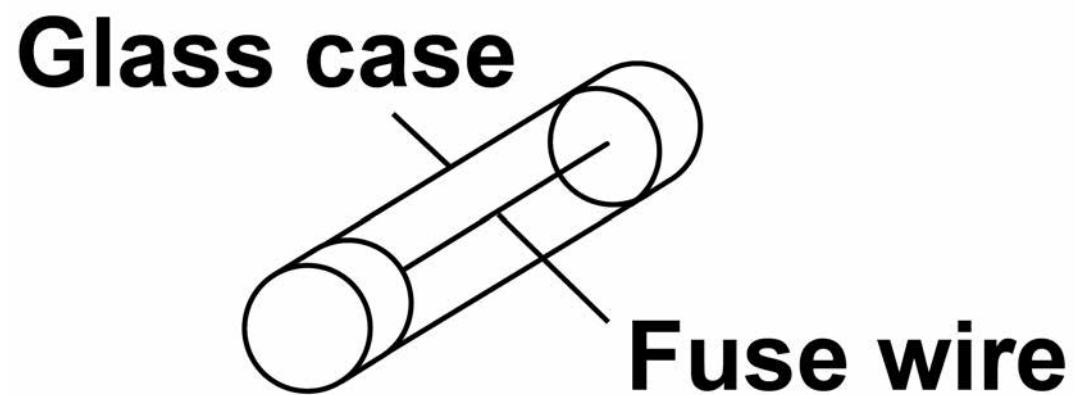

07.3 Write down the equation that links charge flow, current and time. [1 mark]

47

07.4 The fuse wire melts when 1.52 coulombs of charge flows through the fuse in 0.40 seconds.

Calculate the current at which the fuse wire melts. [3 marks]

Current = _____ A

[Turn over]



BLANK PAGE



49

07.5 The mass of the fuse wire is 0.00175 kg. The specific latent heat of fusion of the fuse wire is 205 000 J/kg.

Calculate the energy needed to melt the fuse wire.

Use the Physics Equations Sheet. [2 marks]

Energy = _____ J

9

[Turn over]



0 8

FIGURE 10 shows a hot water tank made of copper.

FIGURE 10

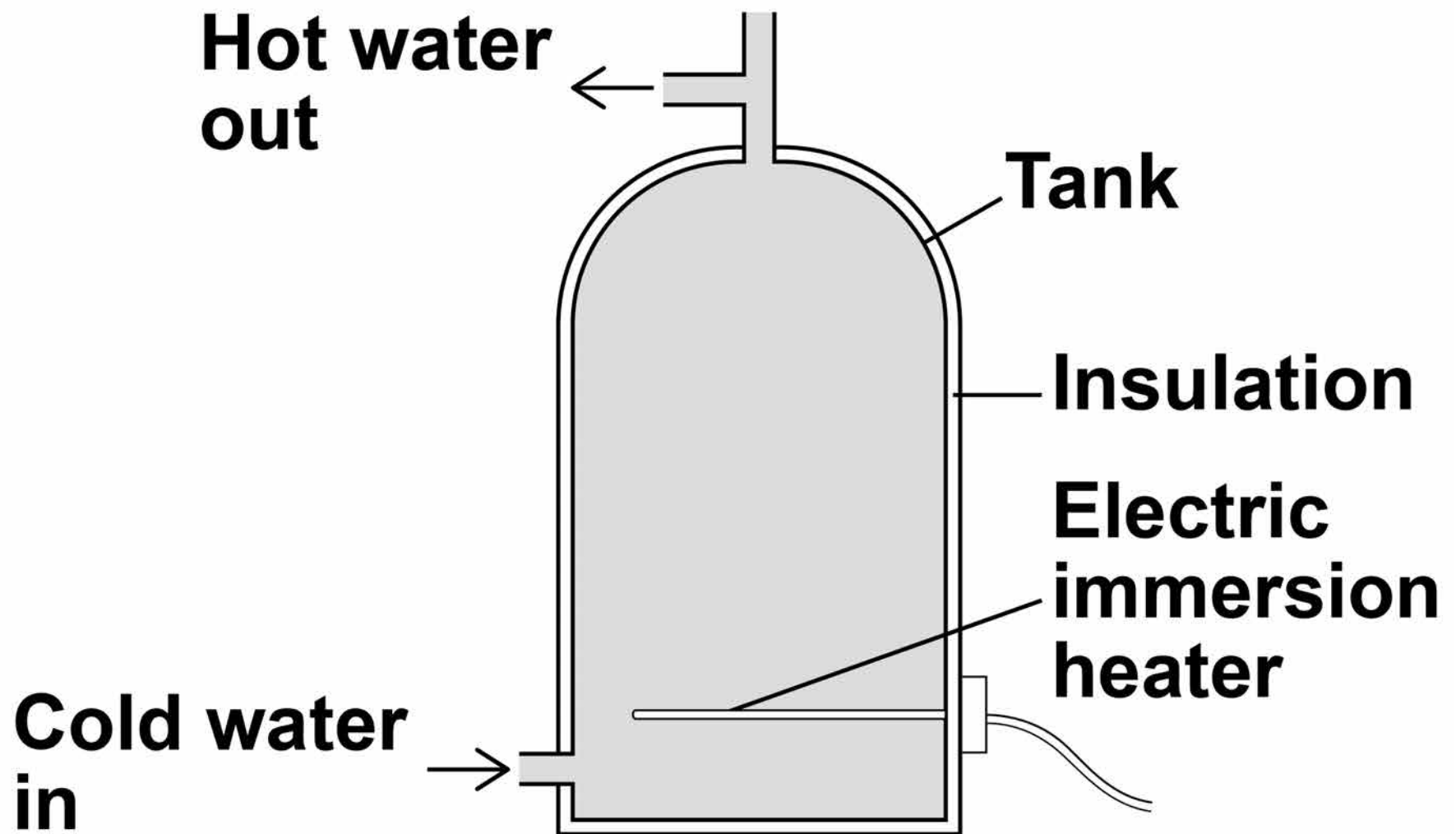

51

0 8 . 1 Copper has a higher thermal conductivity than most metals.

How does the rate of energy transfer through copper compare with the rate of energy transfer through most metals?

Tick ONE box. [1 mark]

Higher

Lower

The same

[Turn over]



BLANK PAGE



53

0 8 . 2 The tank is insulated. When the water is hot, the immersion heater switches off.

**Complete the sentences.
[2 marks]**

Compared to a tank with no insulation, the rate of energy transfer from the water in an insulated tank is

_____.

This means that the water in the insulated tank stays
_____ **for longer.**

[Turn over]

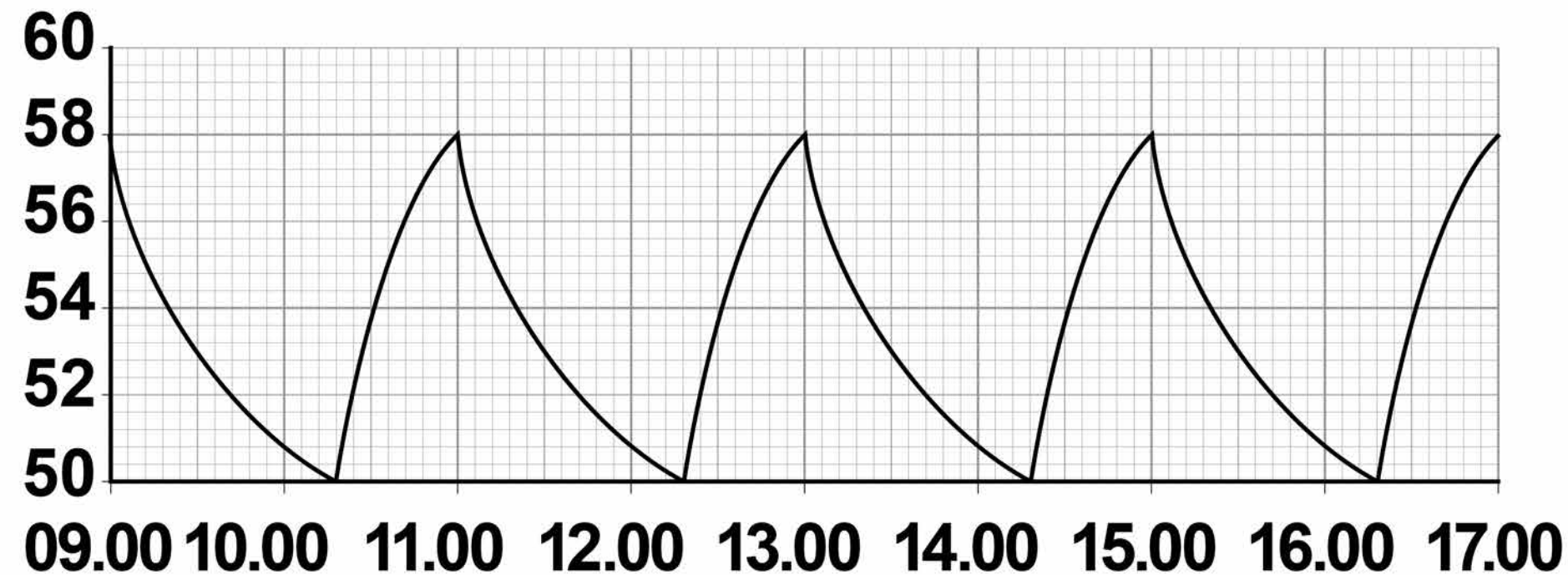

FIGURE 11 shows how temperature varies with time for water in a tank heated with an immersion heater.

FIGURE 12, on the opposite page, shows how temperature varies with time for water in a tank heated with a solar panel.

FIGURE 11

**Temperature
of water
in °C**



Time of day



FIGURE 12

Temperature
of water
in °C

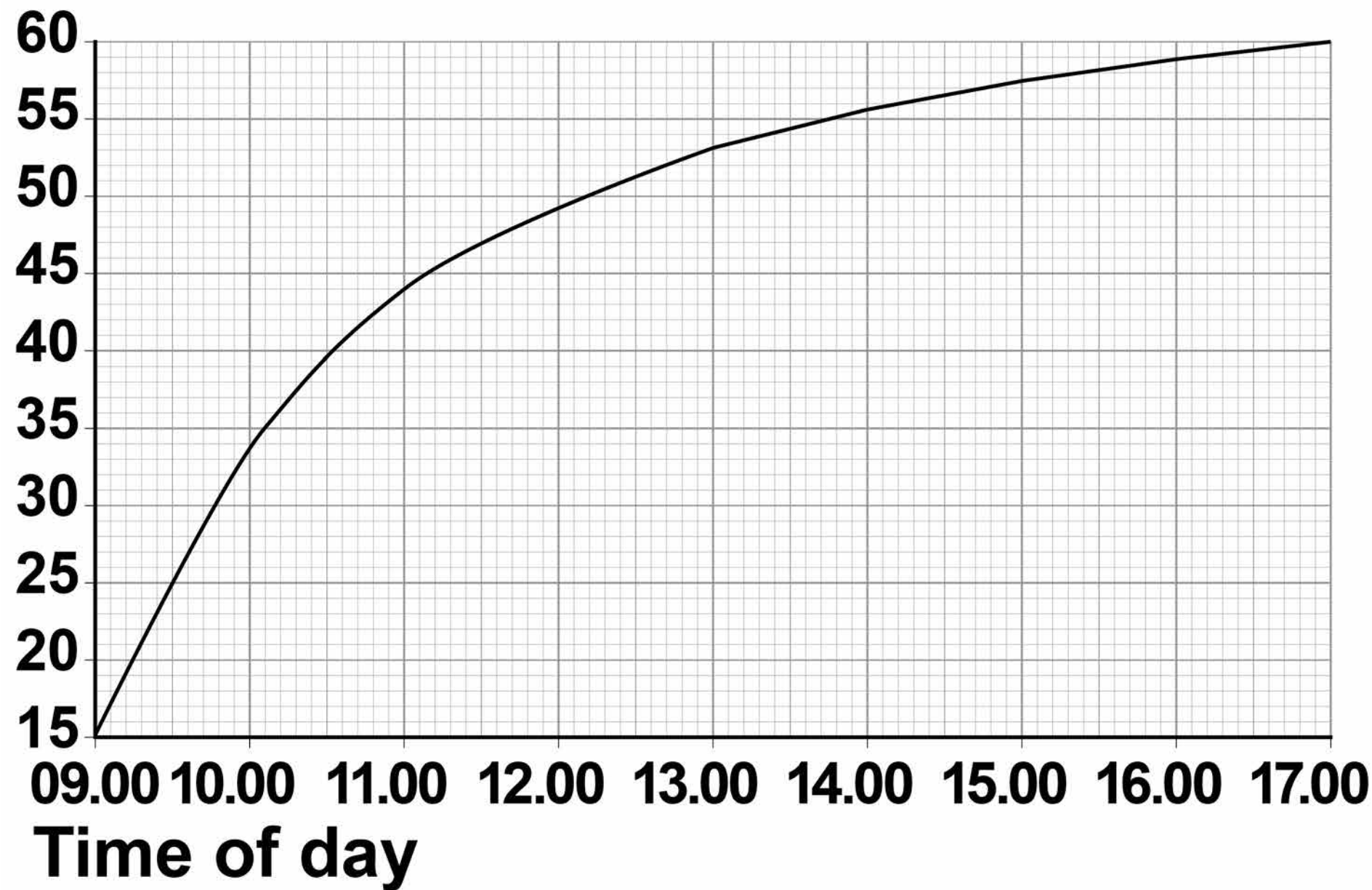

55

[Turn over]



BLANK PAGE

56



0 8 . 3

Give ONE advantage and ONE disadvantage of heating the water using solar panels rather than an immersion heater.

Use only information from FIGURE 11, on page 54, and FIGURE 12, on page 55. [2 marks]

Advantage of solar panels _____

Disadvantage of solar panels _____

[Turn over]



58

0 8 . 4 During one morning, a total of 4 070 000 J of energy is transferred from the electric immersion heater.

4 030 000 J of energy are transferred to the water.

Calculate the proportion of the total energy transferred to the water. [2 marks]

Proportion of total energy =



59

0 8 . 5 Write down the equation that links energy transferred, power and time. [1 mark]

0 8 . 6 The power output of the immersion heater is 5000 W.

Calculate the time taken for the immersion heater to transfer 4 070 000 J of energy.

Give the unit. [4 marks]

Time = _____

Unit _____

[Turn over]

12



0 9

FIGURE 13 shows a lift inside a building.

FIGURE 13



61

09.1 The motor in the lift does 120 000 J of work in 8.0 seconds.

Calculate the power output of the motor in the lift. [2 marks]

Use the equation:

$$\text{Power output} = \frac{\text{work done}}{\text{time}}$$

Power output = _____ W

[Turn over]



62

0 9 . 2 The power input to the motor is greater than the power output.

**Tick TWO reasons why.
[2 marks]**

Energy is transferred in heating the surroundings.

Friction causes energy to be transferred in non-useful ways.

The motor is connected to the mains electricity supply.

The motor is more than 100% efficient.

There are only four people in the lift.



BLANK PAGE

[Turn over]



64

09.3 FIGURE 14 shows part of the circuit that operates the lift motor.

FIGURE 14

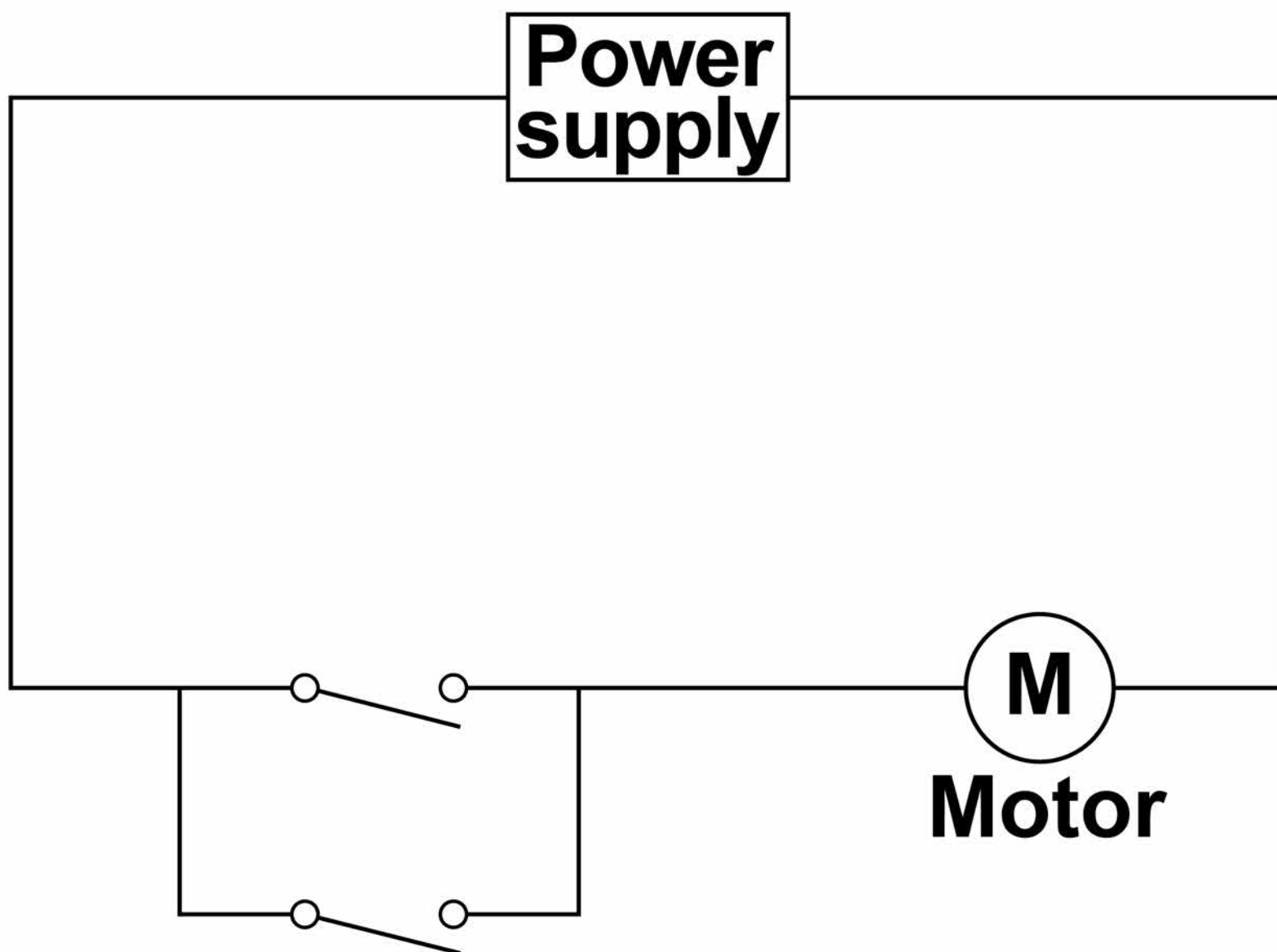

65

The lift can be operated using either of the two switches.

Explain why. [2 marks]

0 9 . 4

Write down the equation that links gravitational field strength, gravitational potential energy, height and mass. [1 mark]

[Turn over]



66

0 9 . 5 The lift goes up 14 m. The total mass of the people in the lift is 280 kg.

**gravitational field strength
= 9.8 N/kg**

**Calculate the increase in
gravitational potential energy
of the people in the lift.**

**Give your answer to
2 significant figures. [3 marks]**

**Increase in gravitational
potential energy =**

J

10



67

BLANK PAGE

[Turn over]



68

1	0
---	---

FIGURE 15 shows a student walking on a carpet.

FIGURE 15



1	0	.	1
---	---	---	---

The student becomes negatively charged because of the friction between his socks and the carpet.

Explain why the friction causes the student to become charged. [2 marks]



[Turn over]



70

1 0 . 2 The student's head is represented by the sphere in **FIGURE 16**.

The student is negatively charged. The arrow shows part of the electric field around the student's head.

Draw **THREE** more arrows on **FIGURE 16** to complete the electric field pattern. [1 mark]

FIGURE 16

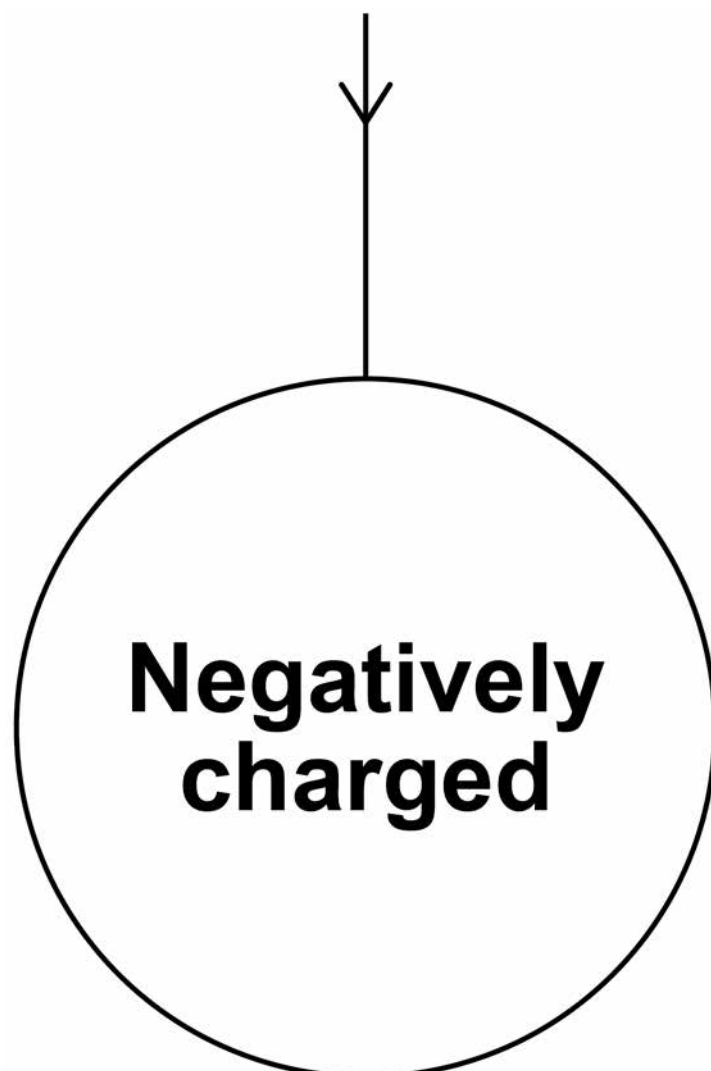

1 0 . 3 The negatively charged student touches a metal tap and receives an electric shock.

Explain why. [3 marks]

[Turn over]



1 0 . 4

Some carpets have thin copper wires running through them. The student is less likely to receive an electric shock after walking on this type of carpet.

Suggest why. [2 marks]

Horizontal lines for student response

8



73

BLANK PAGE

[Turn over]



74

1	1
---	---

A teacher used a Geiger-Muller tube and counter to measure the number of counts in 60 seconds for a radioactive rock.

1	1	.	1
---	---	---	---

The counter recorded 819 counts in 60 seconds. The background radiation count rate was 0.30 counts per second.

Calculate the count rate for the rock. [3 marks]

Count rate =

_____ per second



75

1 1 . 2 A householder is worried about the radiation emitted by the granite worktop in his kitchen.

1 kg of granite has an activity of 1250 Bq. The kitchen worktop has a mass of 180 kg.

Calculate the activity of the kitchen worktop in Bq.
[2 marks]

Activity = _____ Bq

[Turn over]



1 1 . 3 The average total radiation dose per year in the UK is 2.0 millisieverts.

TABLE 2 shows the effects of radiation dose on the human body.

TABLE 2

Radiation dose in millisieverts	Effects
10 000	Immediate illness; death within a few weeks
1000	Radiation sickness; unlikely to cause death
100	Lowest dose with evidence of causing cancer



77

The average radiation dose from the granite worktop is 0.003 millisieverts per day.

Explain why the householder should NOT be concerned about his yearly radiation dose from the granite worktop.

**One year is 365 days.
[2 marks]**

[Turn over]



78

1 1 . 4 Bananas are a source of background radiation. Some people think that the unit of radiation dose should be changed from sieverts to Banana Equivalent Dose.

Suggest ONE reason why the Banana Equivalent Dose may help the public be more aware of radiation risks. [1 mark]

8



79

1 2

A student investigated how the resistance of a piece of nichrome wire varies with length.

FIGURE 17 shows part of the circuit the student used.

FIGURE 17

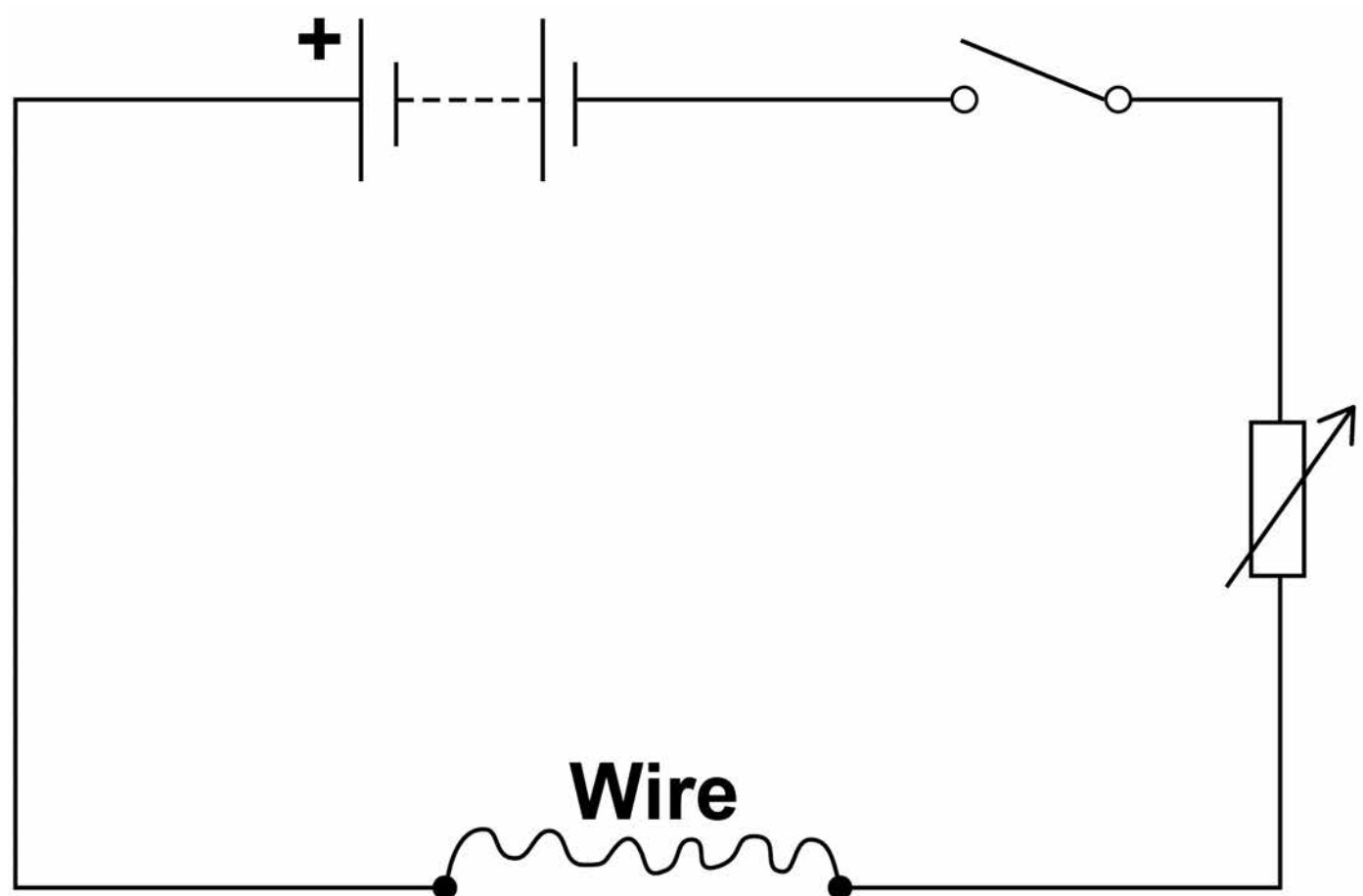

1 2 . 1

Complete FIGURE 17 by adding an ammeter and a voltmeter.

Use the correct circuit symbols. [3 marks]

[Turn over]



1 2 . 2

Describe how the student would obtain the data needed for the investigation.

**Your answer should include a risk assessment for ONE hazard in the investigation.
[6 marks]**

[Turn over]



1 2 . 3 Why would switching off the circuit between readings have improved the accuracy of the student's investigation?

Tick ONE box. [1 mark]

The charge flow through the wire would not change.

The potential difference of the battery would not increase.

The power output of the battery would not increase.

The temperature of the wire would not change.



1 2 . 4 The student used crocodile clips to make connections to the wire.

They could have used a piece of equipment called a 'jockey'.

FIGURE 18, on page 84, shows a crocodile clip and a jockey in contact with a wire.

[Turn over]

84

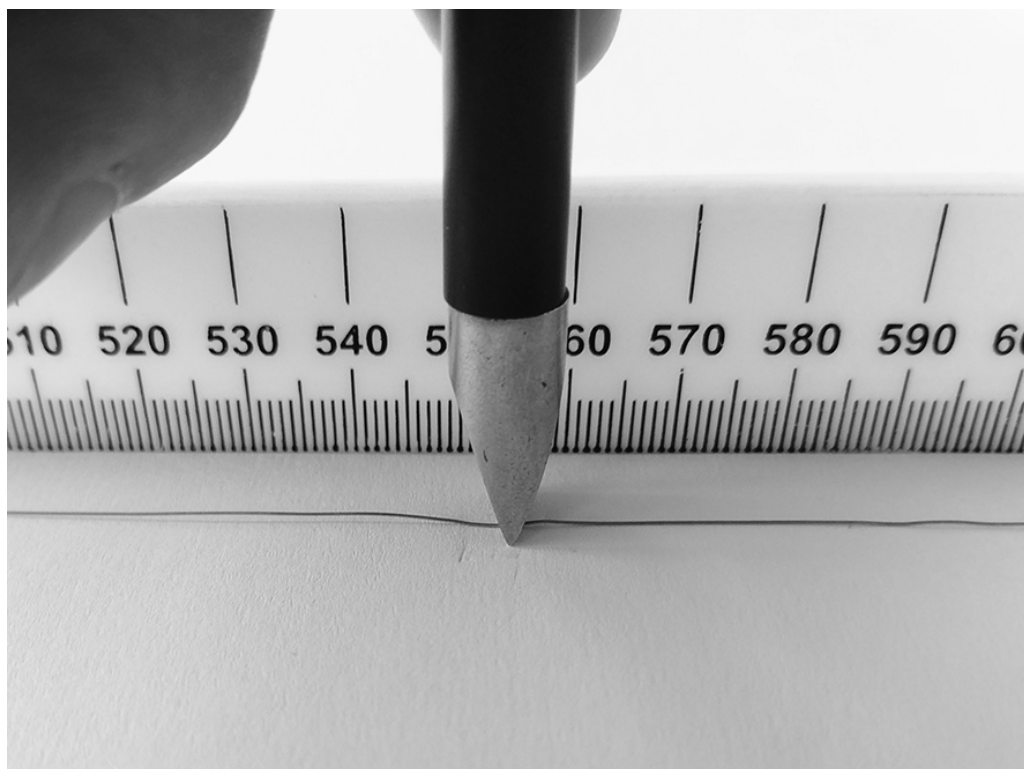
FIGURE 18**Crocodile clip****Jockey**

How would using the jockey have affected the accuracy and resolution of the student's results compared to using the crocodile clip?



85

Tick TWO boxes. [2 marks]

The accuracy of the student's results would be higher.

The accuracy of the student's results would be lower.

The accuracy of the student's results would be the same.

The resolution of the length measurement would be higher.

The resolution of the length measurement would be lower.

The resolution of the length measurement would be the same.

END OF QUESTIONS

12



86

There are no questions printed on this page

For Examiner's Use	
Question	Mark
1	
2	
3	
4	
5	
6	
7	
8	
9	
10	
11	
12	
TOTAL	

Copyright information

For confidentiality purposes, from the November 2015 examination series, acknowledgements of third party copyright material will be published in a separate booklet rather than including them on the examination paper or support materials. This booklet is published after each examination series and is available for free download from www.aqa.org.uk after the live examination series.

Permission to reproduce all copyright material has been applied for. In some cases, efforts to contact copyright-holders may have been unsuccessful and AQA will be happy to rectify any omissions of acknowledgements. If you have any queries please contact the Copyright Team, AQA, Stag Hill House, Guildford, GU2 7XJ.

Copyright © 2018 AQA and its licensors. All rights reserved.

IB/M/Jun18/NC/8463/1F/E1

