



Surname \_\_\_\_\_

Other Names \_\_\_\_\_

Centre Number \_\_\_\_\_

Candidate Number \_\_\_\_\_

Candidate Signature \_\_\_\_\_

**GCSE  
PHYSICS**

**F**

**Foundation Tier Paper 2**

**8463/2F**

**Friday 15 June 2018 Morning**

**Time allowed: 1 hour 45 minutes**

**For this paper you must have:**

- a ruler
- a scientific calculator
- the Physics Equation Sheet (enclosed).

**At the top of the page, write your surname and other names, your centre number, your candidate number and add your signature.**

**[Turn over]**



BLANK PAGE



## INSTRUCTIONS

- Use black ink or black ball-point pen.
- Answer ALL questions in the spaces provided.
- Do all rough work in this book. Cross through any work you do not want to be marked.
- In all calculations, show clearly how you work out your answer.

## INFORMATION

- The maximum mark for this paper is 100.
- The marks for questions are shown in brackets.
- You are expected to use a calculator where appropriate.
- You are reminded of the need for good English and clear presentation in your answers.

**DO NOT TURN OVER UNTIL TOLD TO DO SO**



**0 1 . 1** The Sun is a star.

**Which galaxy is the Sun in?**

**Tick ONE box. [1 mark]**

**Cartwheel**

**Milky Way**

**Starburst**

**Tadpole**



5

**0 1 . 2** Light takes 500 seconds to travel from the Sun to the Earth.

Light travels at 300 000 kilometres per second.

Calculate the distance between the Sun and the Earth.

Use the equation:

distance = speed × time

[2 marks]

---

---

---

---

---

---

---

---

Distance = \_\_\_\_\_ kilometres

[Turn over]



**TABLE 1** gives information about some of the planets in our solar system.

The planets are in order of increasing distance from the Sun.

**TABLE 1**

<b>Planet</b>	<b>Time to orbit the Sun in years</b>
<b>Mercury</b>	<b>0.2</b>
<b>Venus</b>	<b>0.6</b>
<b>Earth</b>	<b>1.0</b>
<b>Mars</b>	
<b>Jupiter</b>	<b>12.0</b>

**0 1 . 3** There are some planets in our solar system missing from TABLE 1.

**How many planets are missing? [1 mark]**

---

---



**0 1 . 4** Estimate how many years it takes Mars to orbit the Sun. [1 mark]

\_\_\_\_\_ years

**0 1 . 5** Calculate how many times Venus will orbit the Sun in 9 years. [2 marks]

---

---

---

---

---

---

---

---

**In 9 years Venus will orbit the Sun**

\_\_\_\_\_ times.

[Turn over]

7



02

FIGURE 1 shows how a concave lens forms an image of an object.

FIGURE 1

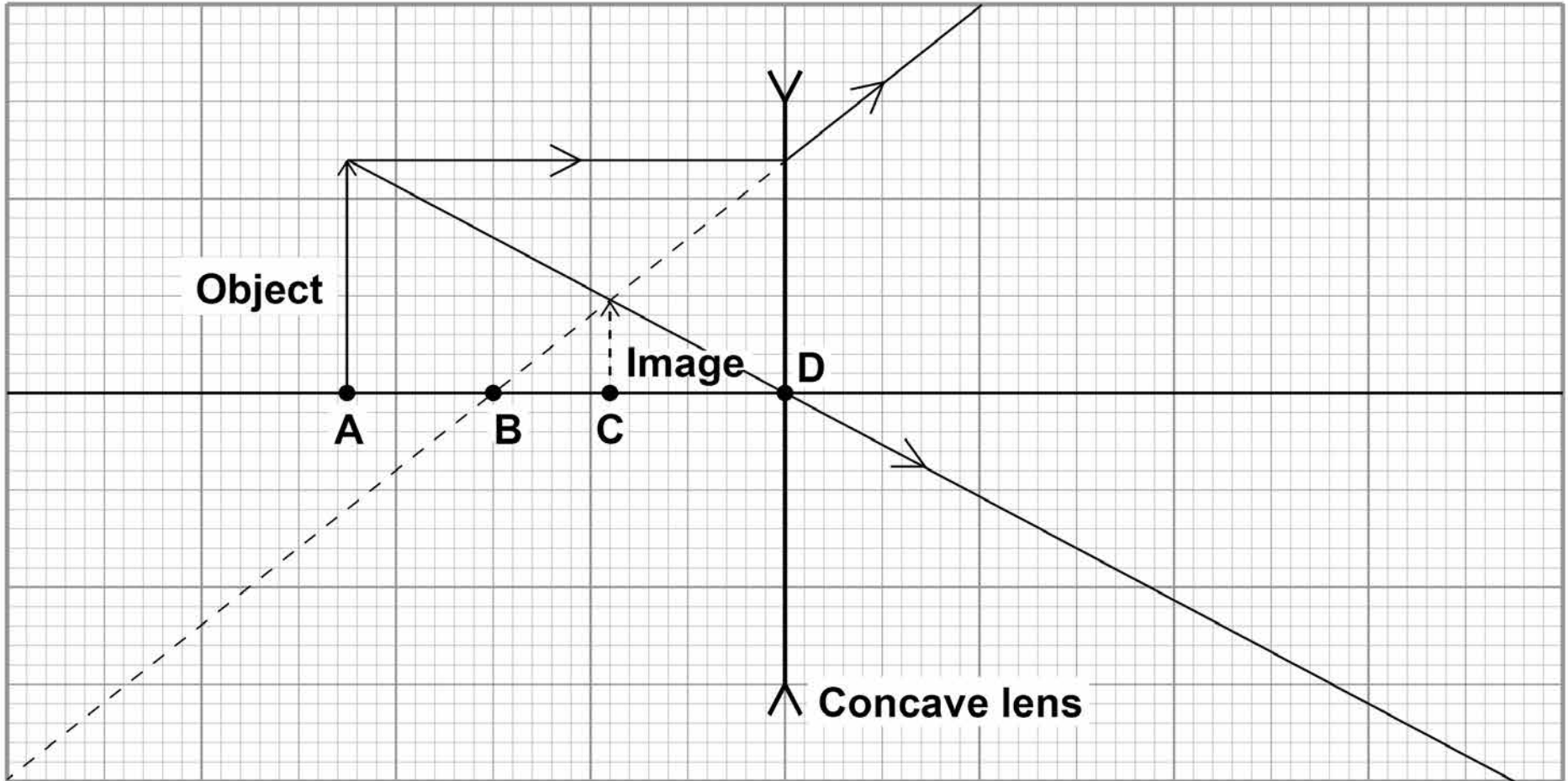



**0 2 . 1** Which point on **FIGURE 1** marks the position of the principal focus of the lens?

Tick **ONE** box. [1 mark]

**A**

**B**

**C**

**D**

[Turn over]



**0 2 . 2** Which TWO words describe the image?

Tick TWO boxes. [2 marks]

**Enlarged**

**Inverted**

**Real**

**Upright**

**Virtual**



**0 2 . 3** Calculate the magnification produced by the lens.

Use the equation:

$$\text{magnification} = \frac{\text{image height}}{\text{object height}}$$

[4 marks]

---

---

---

---

Magnification = \_\_\_\_\_

[Turn over]

11



BLANK PAGE



**0 2 . 4** Complete the sentence.

Choose an answer from the list. [1 mark]

decrease

increase

not change

As the object is moved further away from the lens, the size of the  
image will \_\_\_\_\_.

[Turn over]

8



03

FIGURE 2 shows a ripple tank that a student used to investigate water waves.

FIGURE 2

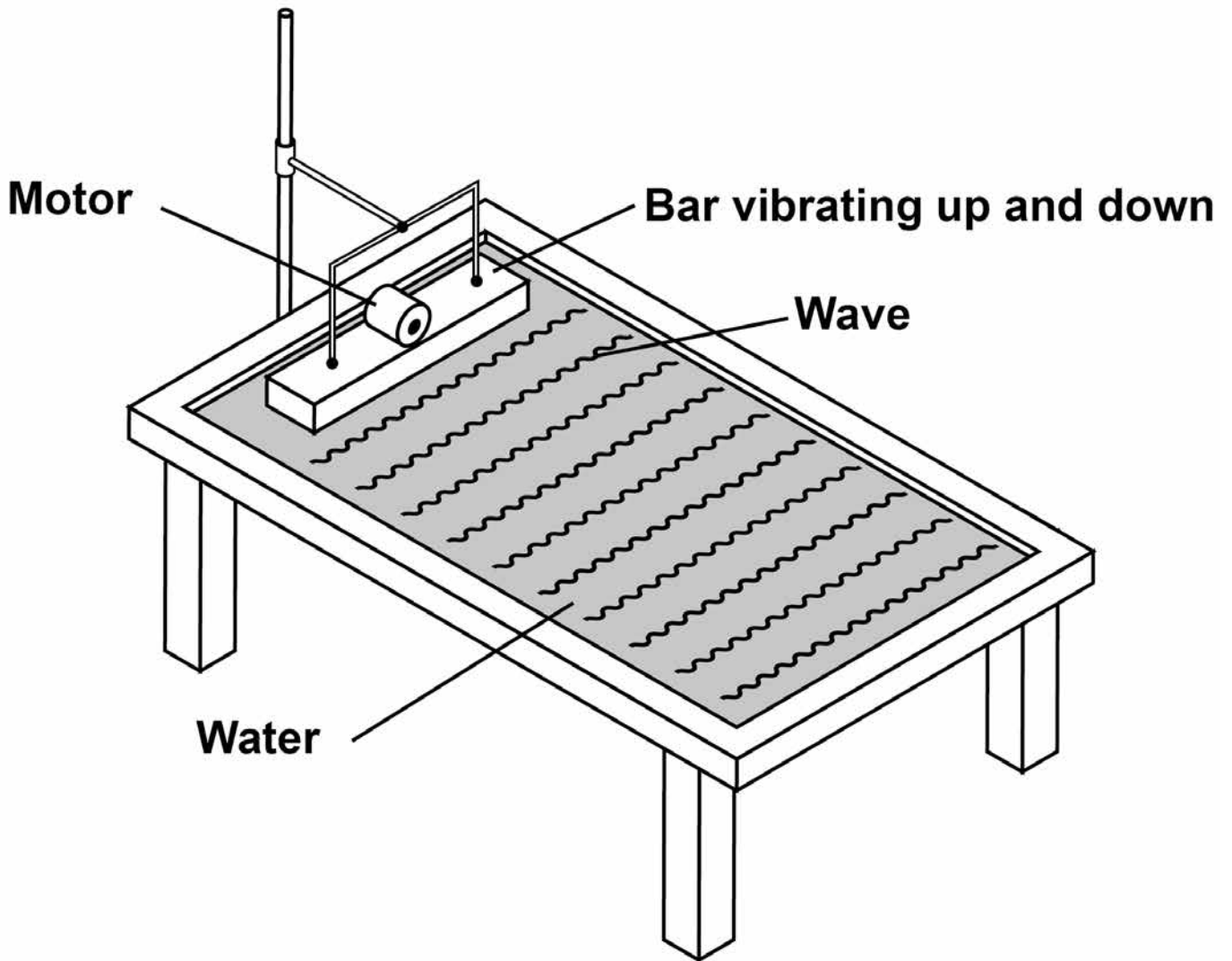

- 03.1** The student adjusted the speed of the motor so that the bar hit the water more times each second.

What happened to the frequency of the waves produced?

Tick ONE box. [1 mark]

Decreased

Did not change

Increased

- 03.2** Describe how the frequency of the water waves in the ripple tank can be measured. [2 marks]

---

---

---

---

---

---

---

[Turn over]



**0 3 . 3** The student measured the frequency of the water waves as 5 hertz.

Calculate the period of the water waves.

Use the equation:

$$\text{period} = \frac{1}{\text{frequency}}$$

Choose the unit from the list. [3 marks]

metres

metres / second

seconds

---

---

---

---

---

---

Period = \_\_\_\_\_ Unit \_\_\_\_\_

6





**0 4**

**FIGURE 3** shows two paper clips hanging from a bar magnet.

**FIGURE 3**

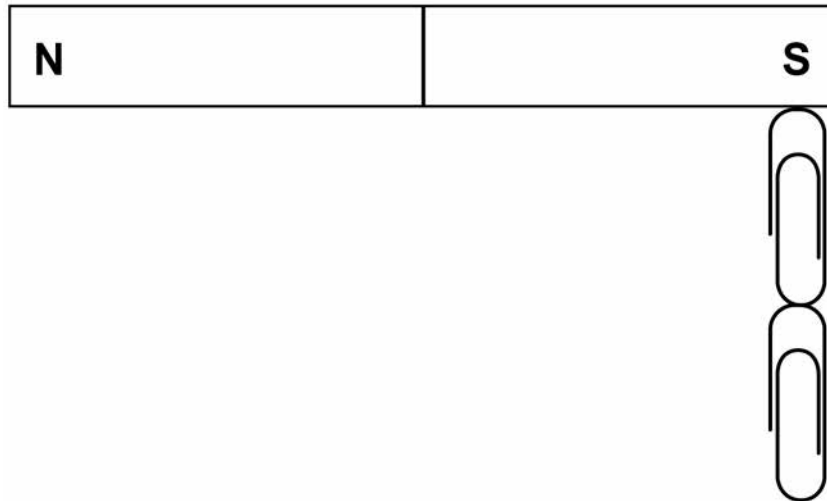

**The paper clips have become magnetised.**

**0 4 . 1**

**Label the north and south poles of both paper clips. [1 mark]**

**[Turn over]**



A student investigated how the number of turns of wire on an electromagnet affects the strength of the electromagnet.

FIGURE 4 shows the equipment used by the student. Throughout the investigation the student kept the current through the wire constant.

FIGURE 4

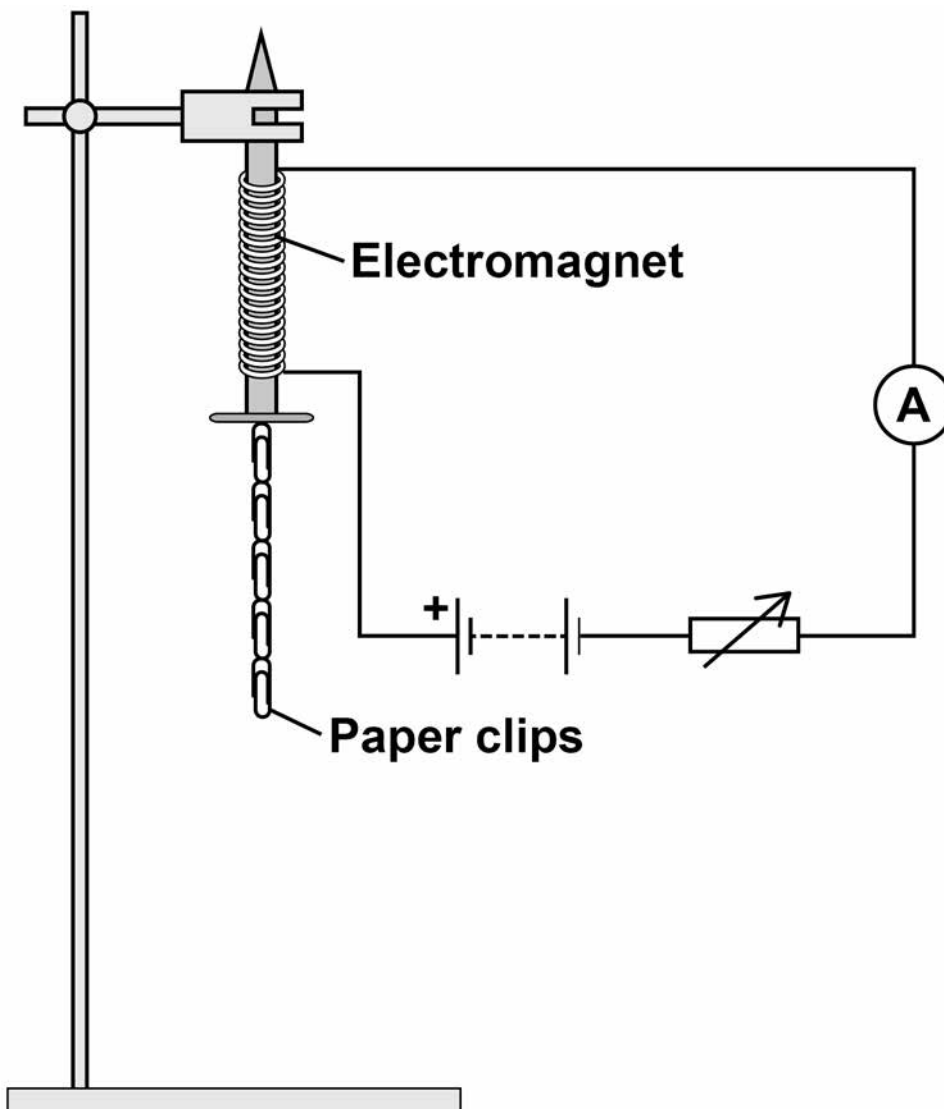

**0 4 . 2** The student measured the strength of the electromagnet by counting the number of paper clips the electromagnet could hold.

**Explain why it was important that the paper clips were all the same size. [2 marks]**

---

---

---

---

---

---

---

---

**[Turn over]**



TABLE 2 shows the student's results.

TABLE 2

Number of turns of wire on the electromagnet	Number of paper clips held
10	3
20	6
30	9
40	12

**0 4 . 3** Describe the pattern shown in TABLE 2.  
[2 marks]

---

---

---

---

---

---

---



**0 4 . 4** The student then used 50 turns of wire on the electromagnet.

The electromagnet picked up 18 paper clips. This was more paper clips than the student had expected.

Which **ONE** is the most likely cause of this result?

Tick **ONE** box. [1 mark]

The paper clips used with 50 turns were larger than the others.

There were less than 50 turns of wire on the electromagnet.

Some of the paper clips were already magnetised.

[Turn over]



**0 4 . 5** The student repeated the measurement for 50 turns of wire three more times.

**This gave her the following set of results.**

**18**

**16**

**14**

**15**

**Explain what the student should now do with the FOUR results for 50 turns of wire. [3 marks]**

---

---

---

---

---

---

---

---

---

---

---

---



**0 4 . 6** The student wrote the hypothesis:

**‘Increasing the current through the wire will make the electromagnet stronger.’**

**Describe how the student should change the investigation to test this hypothesis. [3 marks]**

---

---

---

---

---

---

---

---

---

---

---

---

**[Turn over]**

<b>12</b>



05

Some objects are transparent and some objects are opaque.

05.1

Which ONE of the objects in FIGURE 5 is transparent?

Tick ONE box. [1 mark]

FIGURE 5

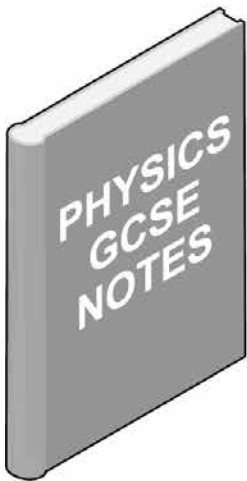

Book



Pencil rubber

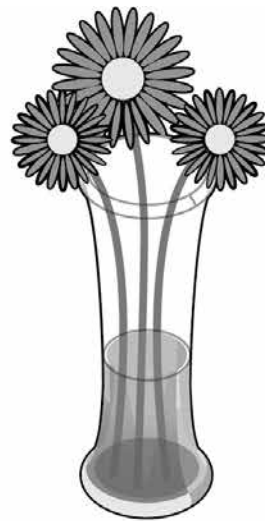

Glass vase



Ceramic Mug





**0 5 . 2** Complete the sentence.

Choose an answer from the list. [1 mark]

absorb

reflect

transmit

An opaque object does not

\_\_\_\_\_ light.

[Turn over]



A student wears a white T-shirt and a red baseball cap to a party.

**0 5 . 3** Why does the T-shirt look white in white light?  
[1 mark]

---

---

---

**0 5 . 4** Explain how the colour of the baseball cap appears to change when the room lights at the party change from white to blue. [2 marks]

---

---

---

---

---

---



A student investigated how the type of surface affects the amount of infrared radiation the surface absorbs.

FIGURE 6 shows the equipment that the student used.

FIGURE 6

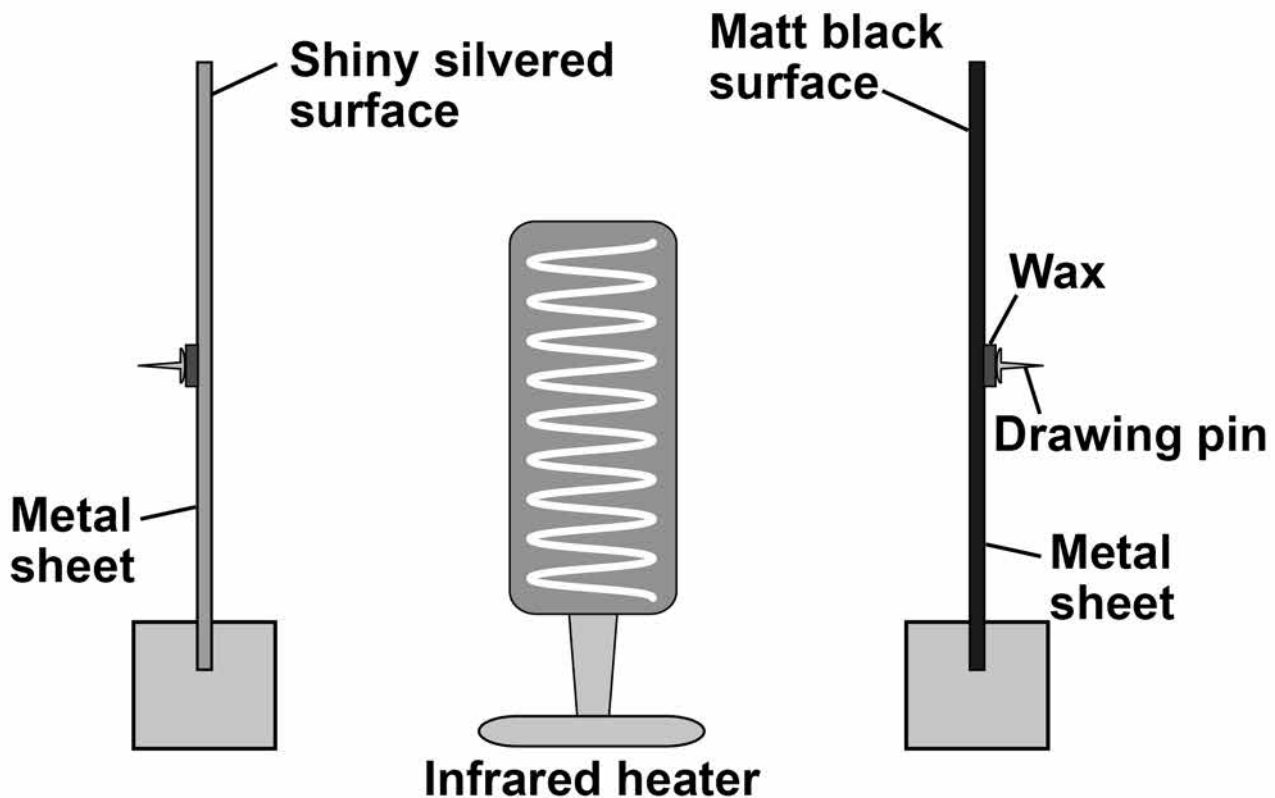

The metal sheets absorb infrared radiation. The wax melts and the drawing pins fall off the surfaces.

[Turn over]



**0 5 . 5** In the investigation there are several variables.

Draw **ONE** line from each variable to the correct description of that variable. [2 marks]

**VARIABLE****DESCRIPTION**

Control

Distance from the metal sheets to the infrared heater.

Dependent

The surface colour of the metal sheets.

Independent

Time taken for the drawing pins to fall off.



**0 5 . 6** What is the main hazard in this investigation?  
[1 mark]

---

---

---

**0 5 . 7** The drawing pin attached to the matt black metal sheet fell off first.

What can be concluded from this result?  
[1 mark]

---

---

---

[Turn over]

9



**06**

**FIGURE 7** shows four blocks of different materials floating on water.

The four blocks are the same volume.

**FIGURE 7**

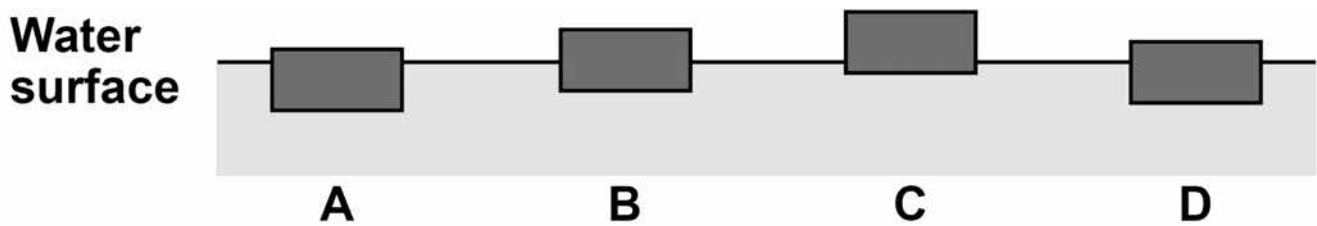
**06.1**

Which of the blocks has the smallest weight?

Tick ONE box. [1 mark]

**A****B****C****D**

**BLANK PAGE**

**[Turn over]**



FIGURE 8 shows a lifebuoy next to a deep swimming pool.

FIGURE 8

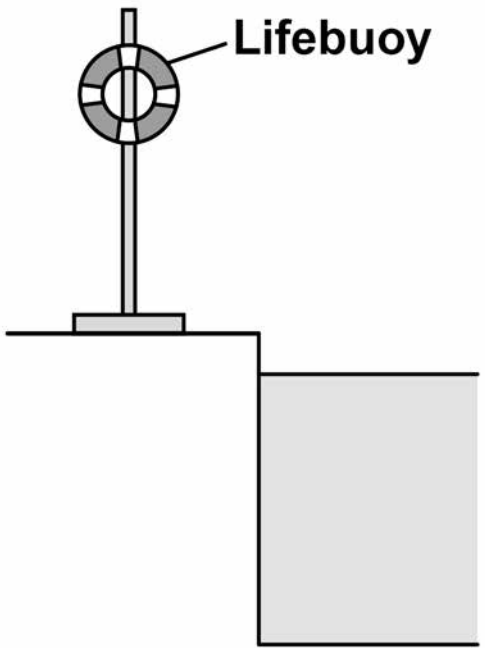



**06.2** The lifebuoy has a mass of 2.5 kg.

gravitational field strength = 9.8 N/kg

Calculate the weight of the lifebuoy.

Use the equation:

weight = mass × gravitational field strength

[2 marks]

---

---

---

---

---

---

---

Weight = \_\_\_\_\_ N

[Turn over]



- 0 6 . 3** When thrown into the water the lifebuoy floats. The two forces acting on the lifebuoy are the weight of the lifebuoy downwards and upthrust upwards.

How big is the upthrust on the lifebuoy compared to the weight of the lifebuoy?

Tick ONE box. [1 mark]

The upthrust is greater than the weight.

The upthrust is less than the weight.

The upthrust is the same as the weight.

- 0 6 . 4** Write down the equation which links acceleration, mass and resultant force. [1 mark]

---

---



**06.5** A rope is used to pull the lifebuoy to the side of the swimming pool.

A resultant force of 4.0 N acts on the lifebuoy.

The mass of the lifebuoy is 2.5 kg.

Calculate the acceleration of the lifebuoy.

[3 marks]

---

---

---

---

---

---

---

Acceleration = \_\_\_\_\_ m/s<sup>2</sup>

[Turn over]

8



- 07** **FIGURE 9** shows a fork-lift truck lifting a heavy crate.

**FIGURE 9**

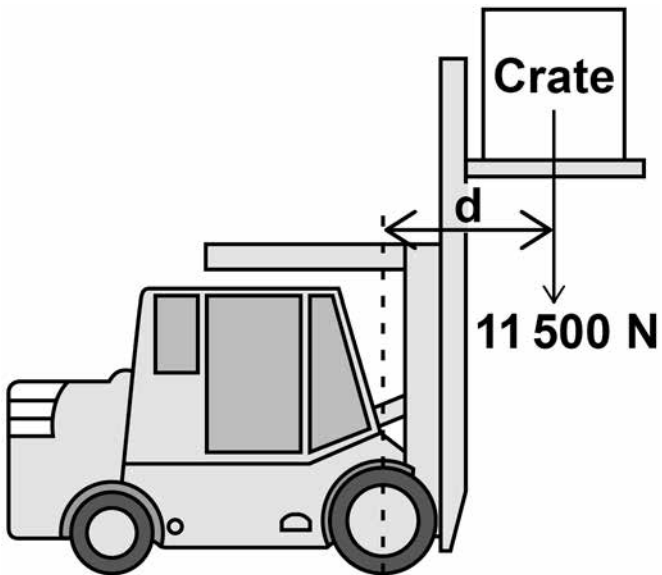

- 07.1** The crate weighs 11 500 N and is lifted vertically 2.60 m.

Calculate the work done to lift the crate.

Use the equation:

work done = force  $\times$  distance

[2 marks]

---

---

---

Work done = \_\_\_\_\_ J



The weight of the crate causes a clockwise moment of 13 800 Nm about the centre of the front wheel of the fork-lift truck.

- 07.2** The weight of the fork-lift truck and driver cause an anticlockwise moment.

What is the minimum size of the anticlockwise moment needed so that the fork-lift truck does NOT topple over? [1 mark]

---

---

- 07.3** Write down the equation which links distance, force and moment of a force. [1 mark]

---

---

[Turn over]



BLANK PAGE



**07.4** Calculate the distance 'd' marked on FIGURE 9.  
[3 marks]

---

---

---

---

---

---

---

Distance 'd' = \_\_\_\_\_ m

[Turn over]

7



**0 8**

**FIGURE 10** shows the position of three types of wave in the electromagnetic spectrum.

**FIGURE 10**

Radio waves	A	B	C	Ultraviolet	X-rays	D
-------------	---	---	---	-------------	--------	---

**0 8****. 1**

Which position shows where visible light is in the spectrum?

Tick **ONE** box. [1 mark]

**A****B****C****D**



**0 8 . 2** Which **ONE** of the statements about electromagnetic waves is correct?

Tick **ONE** box. [1 mark]

- Radio waves have a higher frequency than X-rays.
- Radio waves have a longer wavelength than ultraviolet.
- X-rays have a longer wavelength than radio waves.
- X-rays travel faster through the air than ultraviolet.

**0 8 . 3** Give **ONE** possible danger of exposing your skin to ultraviolet radiation. [1 mark]

---

---

---

[Turn over]



**08.4** Having an X-ray taken exposes a person to ionising radiation.

**TABLE 3** gives the average radiation dose for an X-ray of the chest and an X-ray of the upper digestive system.

**TABLE 3**

<b>Part of the body</b>	<b>Radiation dose in millisieverts (mSv)</b>
<b>Upper digestive system</b>	<b>5.0</b>
<b>Chest</b>	<b>0.1</b>



The risk of an X-ray causing cancer is about 1 in 20 000 for each mSv of radiation received.

Compare the risk of developing cancer from having an X-ray of the upper digestive system with the risk from having an X-ray of the chest.

Use the data in TABLE 3. [2 marks]

---

---

---

---

---

---

---

5

[Turn over]



09

FIGURE 11 shows a container filled with water.

The three holes in the side of the container are sealed with rubber stoppers.

FIGURE 11

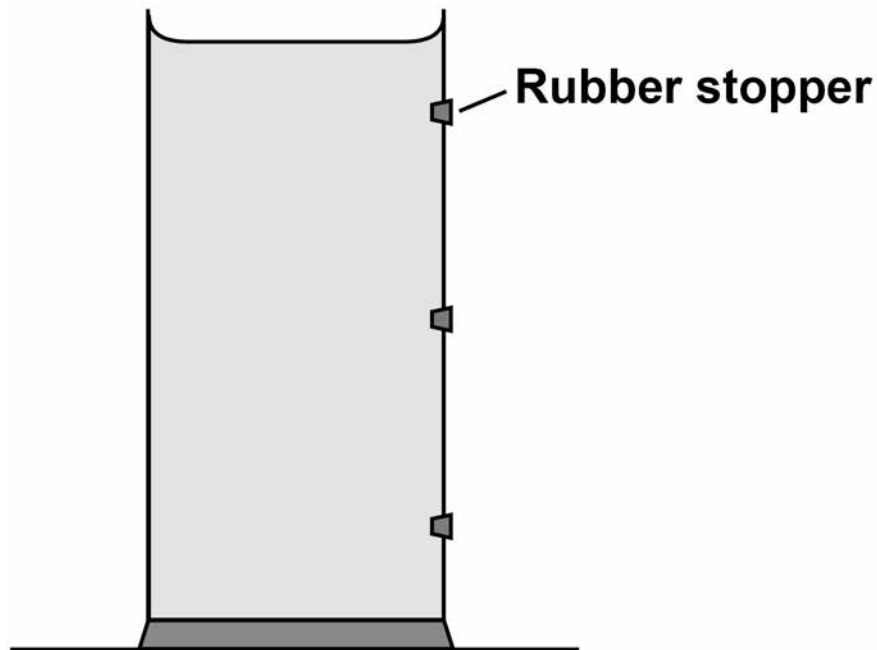

09 . 1

The water exerts a force of 27 N on the bottom of the container.

The cross-sectional area of the bottom of the container is  $0.009 \text{ m}^2$ .



45

Calculate the pressure exerted by the water on the bottom of the container.

Use the equation:

$$\text{pressure} = \frac{\text{force}}{\text{area}}$$

Choose the unit. [3 marks]

kg/m<sup>3</sup>

N/m

Pa

---

---

---

---

---

---

---

Pressure = \_\_\_\_\_ Unit \_\_\_\_\_

[Turn over]



The container is put under running water from a tap and the three rubber stoppers removed.

FIGURE 12 shows the path taken by the water escaping from the top and bottom holes.

FIGURE 12

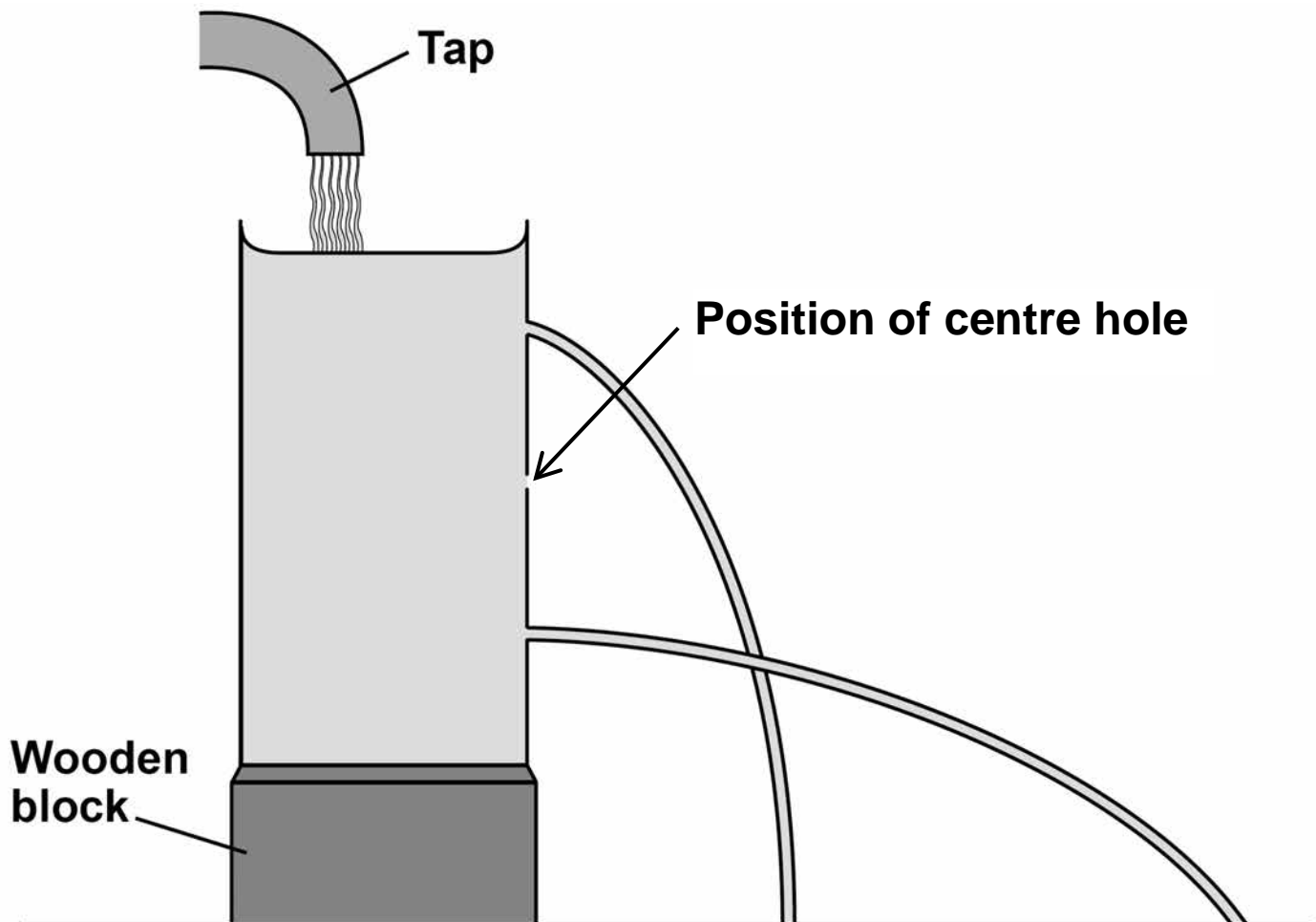

**09.2** Complete FIGURE 12 to show the path taken by the water escaping from the centre hole.  
[1 mark]



**0 9 . 3** What can be concluded from FIGURE 12 about the pressure in a liquid? [1 mark]

---

---

---

**[Turn over]**



**09.4** FIGURE 13 shows a simple model of a liquid.

When a force pushes down on the marbles, the marbles push the sides and bottom of the container outwards.

**FIGURE 13**

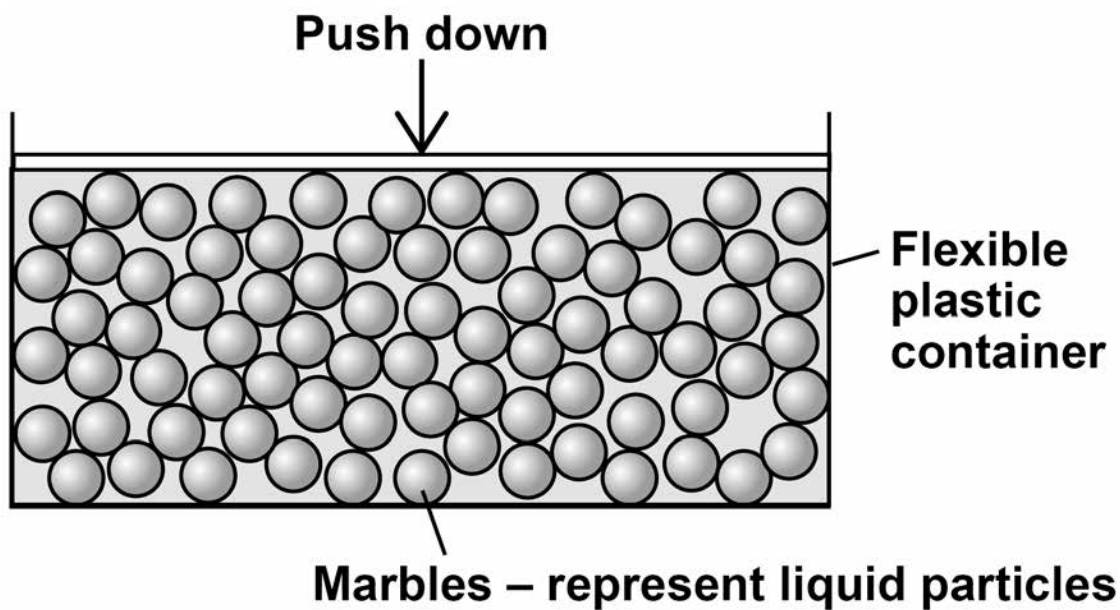

**What can be concluded from this model about the pressure in a liquid? [1 mark]**

---

---

---





**BLANK PAGE**

**[Turn over]**



10

A child drops a ball.

The ball hits the ground and bounces.

FIGURE 14 shows the velocity-time graph for the ball from when the ball is dropped until when the ball reaches the top of its first bounce.

Air resistance has been ignored.

FIGURE 14

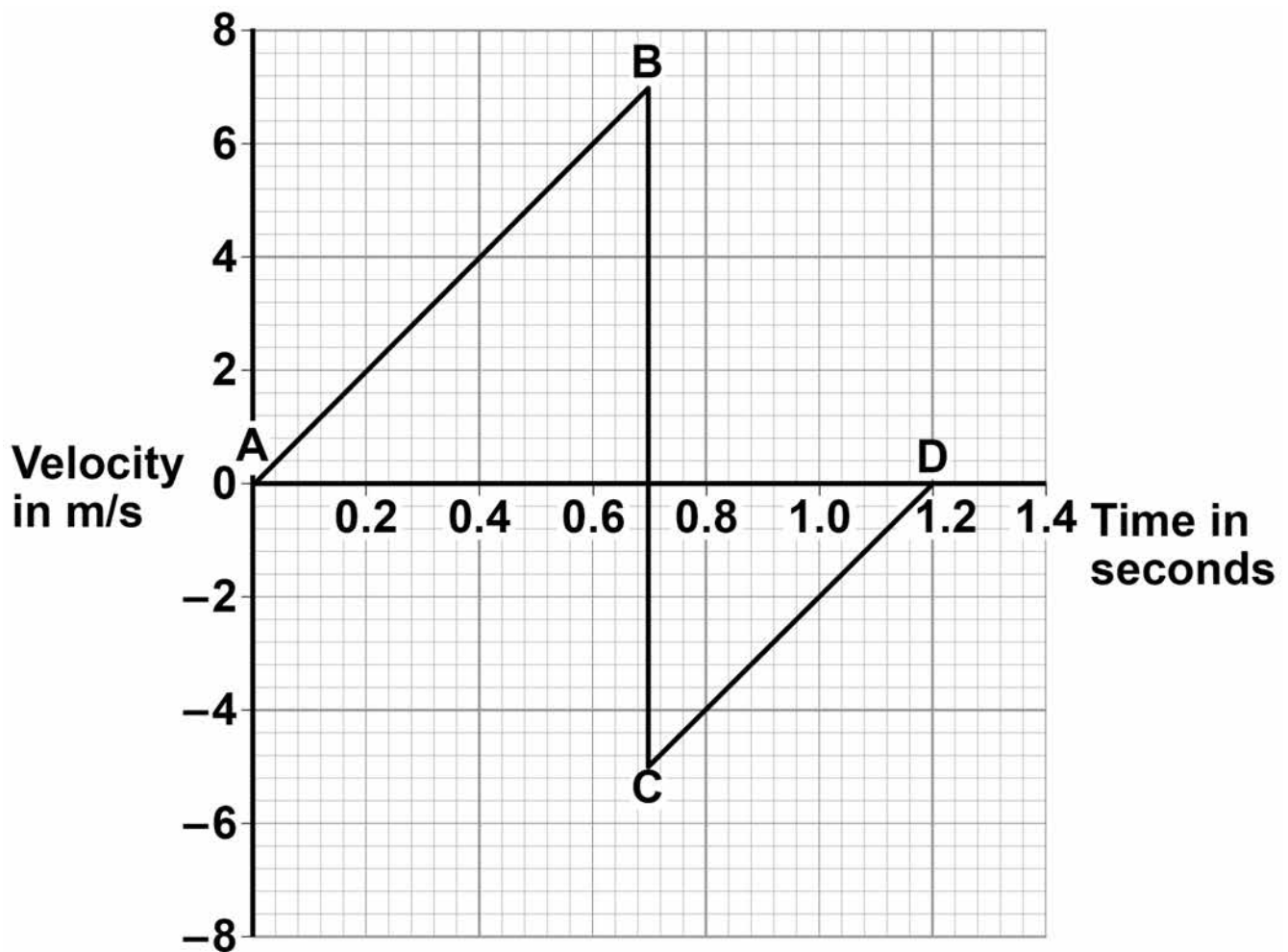

**1 0 . 1** Describe the motion of the ball between points A and B on FIGURE 14. [2 marks]

---

---

---

---

---

---

---

**1 0 . 2** What direction is the ball moving between points C and D on FIGURE 14? [1 mark]

---

---

[Turn over]



**10.3** The ball and the Earth form a system.

What is meant by 'a system'?

Tick ONE box. [1 mark]

A group of objects that interact.

Objects with big differences in mass.

Objects with gravitational potential energy.

**10.4** When the ball hits the ground, energy is transferred from the ball to the Earth.

Explain how the data in FIGURE 14 shows this energy transfer. [4 marks]

---

---

---

---

---

---

---

---



---

---

---

---

---

---

---

---

---

---

---

[Turn over]

8



1	1
---	---

A student carried out an investigation to determine the spring constant of a spring.

TABLE 4 gives the data obtained by the student.

TABLE 4

Force in N	Extension in cm
0	0.0
2	3.5
4	8.0
6	12.5
8	16.0
10	20.0

1	1	.	1
---	---	---	---

Describe a method the student could have used to obtain the data given in TABLE 4.

Your answer should include any cause of inaccuracy in the data.

Your answer may include a labelled diagram.  
[6 marks]



---

---

---

---

**Answer lines for this question continue on the next page.**



**[Turn over]**

---

---

---

---

---

---

---

---

---

---

---

---

---

---

---

---

---

---

---

---

---

---

---

---





---

---

---

---

---

---

---

---

---

---

**1 1 . 2** The student measured the extension for five different forces rather than just measuring the extension for one force.

**Suggest why. [1 mark]**

---

---

---

**[Turn over]**



FIGURE 15 shows some of the data obtained by the student.

FIGURE 15

Extension in centimetres

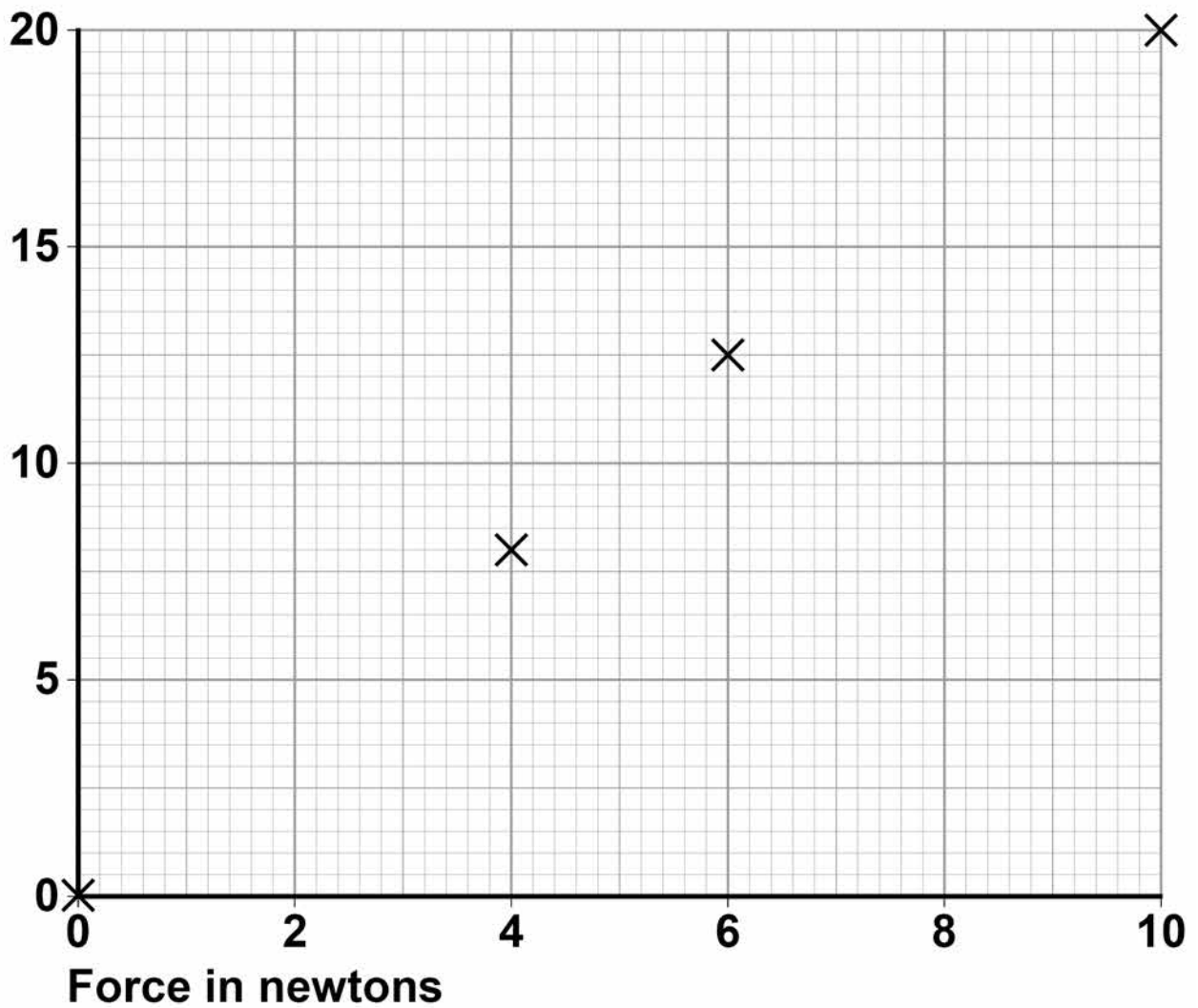

- 1 1 . 3** Complete FIGURE 15 by plotting the missing data from TABLE 4.

Draw the line of best fit.

TABLE 4 is repeated here to help you answer this question. [2 marks]

TABLE 4

Force in N	Extension in cm
0	0.0
2	3.5
4	8.0
6	12.5
8	16.0
10	20.0

- 1 1 . 4** Write down the equation that links extension, force and spring constant. [1 mark]

---

---

[Turn over]



BLANK PAGE



**11.5** Calculate the spring constant of the spring that the student used.

Give your answer in newtons per metre.  
[4 marks]

---

---

---

---

---

---

---

Spring constant = \_\_\_\_\_ N/m

[Turn over]



**1 1 . 6** Hooke's Law states that:  
'The extension of an elastic object is directly proportional to the force applied, provided the limit of proportionality is not exceeded.'

The student concluded that over the range of force used, the spring obeyed Hooke's Law.

Explain how the data supports the student's conclusion. [2 marks]

---

---

---

---

---

---

---

---

16



**1 2** P-waves and S-waves are two types of seismic wave caused by earthquakes.

**1 2 . 1** Which ONE of the statements about P-waves and S-waves is correct?

Tick ONE box. [1 mark]

P-waves and S-waves are transverse.

P-waves and S-waves are longitudinal.

P-waves are transverse and S-waves are longitudinal.

P-waves are longitudinal and S-waves are transverse.

[Turn over]



Seismometers on the Earth's surface record the vibrations caused by seismic waves.

FIGURE 16 shows the vibration recorded by a seismometer for one P-wave.

FIGURE 16

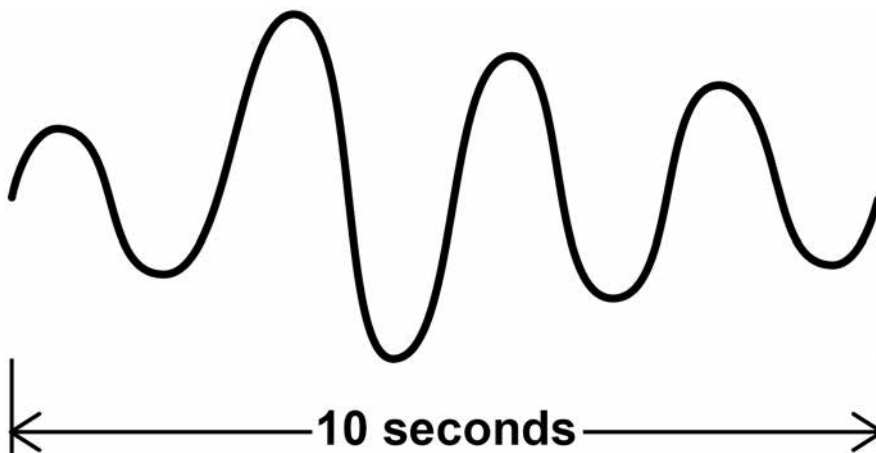

**1 2 . 2** Calculate the frequency of the P-wave shown in FIGURE 16. [1 mark]

---

---

---

Frequency = \_\_\_\_\_ Hz





- 1 2 . 3** Write down the equation which links frequency, wavelength and wave speed. [1 mark]

---

---

- 1 2 . 4** The P-wave shown in FIGURE 16 is travelling at 7200 m/s.

Calculate the wavelength of the P-wave.  
[3 marks]

---

---

---

---

---

---

---

---

Wavelength = \_\_\_\_\_ m

[Turn over]



**1 2 . 5** Explain why the study of seismic waves provides evidence for the structure of the Earth's core. [2 marks]

---

---

---

---

---

---

---

---

---

---

---

**END OF QUESTIONS**

<b>8</b>



**There are no questions printed on this page**



**There are no questions printed on this page**

For Examiner's Use	
Question	Mark
1	
2	
3	
4	
5	
6	
7	
8	
9	
10	
11	
12	
<b>TOTAL</b>	

### Copyright information

For confidentiality purposes, from the November 2015 examination series, acknowledgements of third party copyright material will be published in a separate booklet rather than including them on the examination paper or support materials. This booklet is published after each examination series and is available for free download from [www.aqa.org.uk](http://www.aqa.org.uk) after the live examination series.

Permission to reproduce all copyright material has been applied for. In some cases, efforts to contact copyright-holders may have been unsuccessful and AQA will be happy to rectify any omissions of acknowledgements. If you have any queries please contact the Copyright Team, AQA, Stag Hill House, Guildford, GU2 7XJ

Copyright © 2018 AQA and its licensors. All rights reserved.

**IB/M/Jun18/AMAS/8463/2F/E3**

