

UNIVERSITY OF CAMBRIDGE INTERNATIONAL EXAMINATIONS  
General Certificate of Education  
Advanced Subsidiary Level and Advanced Level

**PHYSICS**

**9702/01**

Paper 1 Multiple Choice

May/June 2006

**1 hour**

Additional Materials: Multiple Choice Answer Sheet  
Soft clean eraser  
Soft pencil (type B or HB is recommended)

**READ THESE INSTRUCTIONS FIRST**

Write in soft pencil.

Do not use staples, paper clips, highlighters, glue or correction fluid.

Write your name, Centre number and candidate number on the Answer Sheet in the spaces provided unless this has been done for you.

There are **forty** questions on this paper. Answer **all** questions. For each question there are four possible answers **A, B, C** and **D**.

Choose the **one** you consider correct and record your choice in **soft pencil** on the separate Answer Sheet.

**Read the instructions on the Answer Sheet very carefully.**

Each correct answer will score one mark. A mark will not be deducted for a wrong answer.  
Any rough working should be done in this booklet.

**Data**

speed of light in free space,	$c = 3.00 \times 10^8 \text{ m s}^{-1}$
permeability of free space,	$\mu_0 = 4\pi \times 10^{-7} \text{ H m}^{-1}$
permittivity of free space,	$\epsilon_0 = 8.85 \times 10^{-12} \text{ F m}^{-1}$
elementary charge,	$e = 1.60 \times 10^{-19} \text{ C}$
the Planck constant,	$h = 6.63 \times 10^{-34} \text{ J s}$
unified atomic mass constant,	$u = 1.66 \times 10^{-27} \text{ kg}$
rest mass of electron,	$m_e = 9.11 \times 10^{-31} \text{ kg}$
rest mass of proton,	$m_p = 1.67 \times 10^{-27} \text{ kg}$
molar gas constant,	$R = 8.31 \text{ J K}^{-1} \text{ mol}^{-1}$
the Avogadro constant,	$N_A = 6.02 \times 10^{23} \text{ mol}^{-1}$
the Boltzmann constant,	$k = 1.38 \times 10^{-23} \text{ J K}^{-1}$
gravitational constant,	$G = 6.67 \times 10^{-11} \text{ N m}^2 \text{ kg}^{-2}$
acceleration of free fall,	$g = 9.81 \text{ m s}^{-2}$

**Formulae**

uniformly accelerated motion,

$$s = ut + \frac{1}{2}at^2$$

$$v^2 = u^2 + 2as$$

work done on/by a gas,

$$W = p\Delta V$$

gravitational potential,

$$\phi = -\frac{Gm}{r}$$

simple harmonic motion,

$$a = -\omega^2 x$$

velocity of particle in s.h.m.,

$$v = v_0 \cos \omega t$$

$$v = \pm \omega \sqrt{(x_0^2 - x^2)}$$

resistors in series,

$$R = R_1 + R_2 + \dots$$

resistors in parallel,

$$1/R = 1/R_1 + 1/R_2 + \dots$$

electric potential,

$$V = \frac{Q}{4\pi\epsilon_0 r}$$

capacitors in series,

$$1/C = 1/C_1 + 1/C_2 + \dots$$

capacitors in parallel,

$$C = C_1 + C_2 + \dots$$

energy of charged capacitor,

$$W = \frac{1}{2}QV$$

alternating current/voltage,

$$x = x_0 \sin \omega t$$

hydrostatic pressure,

$$p = \rho gh$$

pressure of an ideal gas,

$$p = \frac{1}{3} \frac{Nm}{V} \langle c^2 \rangle$$

radioactive decay,

$$x = x_0 \exp(-\lambda t)$$

decay constant,

$$\lambda = \frac{0.693}{t_{\frac{1}{2}}}$$

critical density matter of the Universe,

$$\rho_0 = \frac{3H_0^2}{8\pi G}$$

equation of continuity,

$$Av = \text{constant}$$

Bernoulli equation (simplified),

$$p_1 + \frac{1}{2}\rho v_1^2 = p_2 + \frac{1}{2}\rho v_2^2$$

Stokes' law,

$$F = Ar\eta v$$

Reynolds' number,

$$R_e = \frac{\rho vr}{\eta}$$

drag force in turbulent flow,

$$F = Br^2 \rho v^2$$

4

1 Which pair includes a vector quantity and a scalar quantity?

- A displacement; acceleration
- B force; kinetic energy
- C power; speed
- D work; potential energy

2 For which quantity is the magnitude a reasonable estimate?

- A frequency of a radio wave 500 pHz
- B mass of an atom 500  $\mu\text{g}$
- C the Young modulus of a metal 500 kPa
- D wavelength of green light 500 nm

3 The following physical quantities can be either positive or negative.

$s$  : displacement of a particle along a straight line

$\theta$  : temperature on the Celsius scale

$q$  : electric charge

$V$  : readings on a digital voltmeter

Which of these quantities are vectors?

- A  $s, \theta, q, V$
- B  $s, q, V$
- C  $\theta, V$
- D  $s$  only

- 4 A light meter measures the intensity  $I$  of the light falling on it. Theory suggests that  $I$  is proportional to the inverse square of the distance  $d$ .

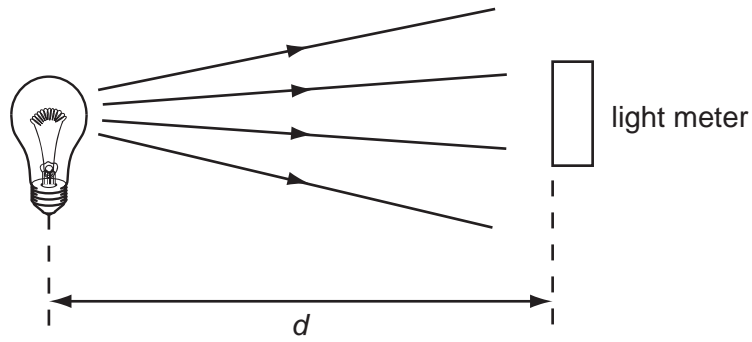

Which graph of the results supports this theory?

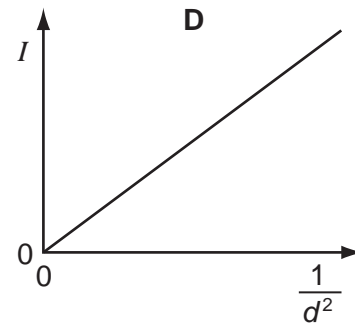
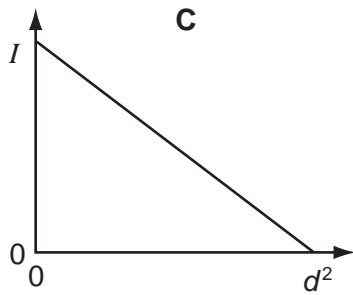
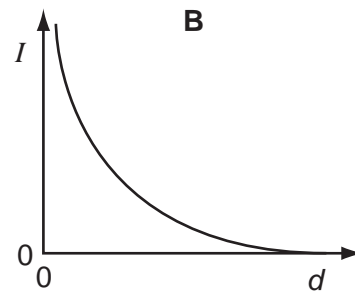
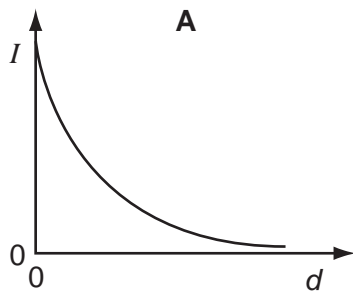

6

- 5 The cathode-ray oscilloscope (c.r.o.) display shows the waveform produced by a circuit. The c.r.o. time-base is set at 10 ms per division.

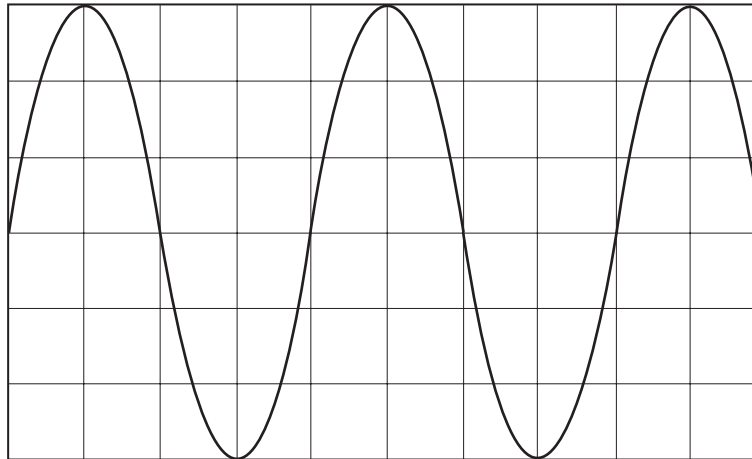

What is the period of the signal shown?

- A** 20 ms      **B** 30 ms      **C** 40 ms      **D** 80 ms
- 6 The resistance  $R$  of an unknown resistor is found by measuring the potential difference  $V$  across the resistor and the current  $I$  through it and using the equation  $R = \frac{V}{I}$ . The voltmeter reading has a 3% uncertainty and the ammeter reading has a 2% uncertainty.

What is the uncertainty in the calculated resistance?

- A** 1.5%      **B** 3%      **C** 5%      **D** 6%
- 7 An experiment is done to measure the acceleration of free fall of a body from rest.

Which measurements are needed?

- A** the height of fall and the time of fall  
**B** the height of fall and the weight of the body  
**C** the mass of the body and the height of fall  
**D** the mass of the body and the time of fall

8 The velocity of an object during the first five seconds of its motion is shown on the graph

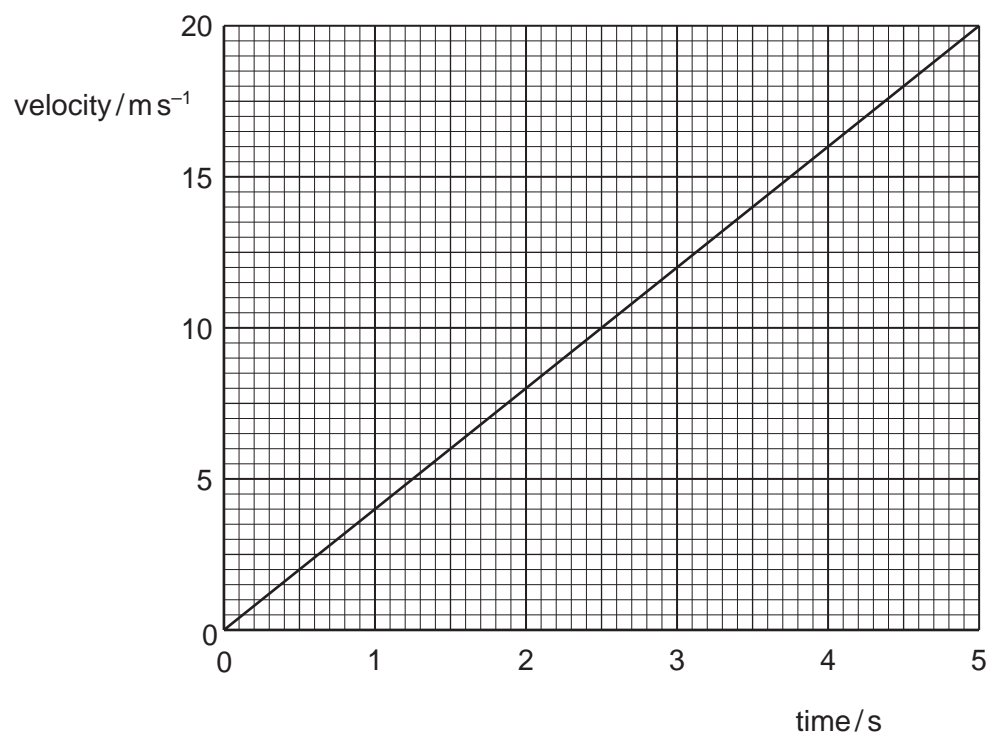

What is the distance travelled by the object in this time?

- A** 4 m            **B** 20 m            **C** 50 m            **D** 100 m

9 The diagram shows a velocity-time graph for a mass moving up and down on the end of a spring.

Which point represents the velocity of the mass when at the lowest point of its motion?

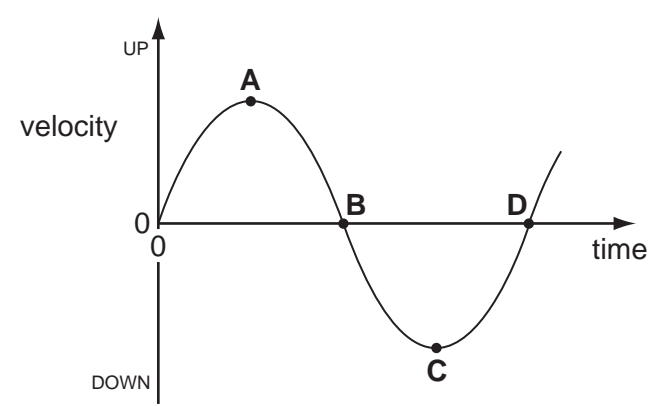

- 10 A cyclist is riding at a steady speed on a level road.

According to Newton's third law of motion, what is equal and opposite to the backward push of the back wheel on the road?

- A the force exerted by the cyclist on the pedals
  - B the forward push of the road on the back wheel
  - C the tension in the cycle chain
  - D the total air resistance and friction force
- 11 In perfectly elastic collisions between two atoms, it is always true to say that
- A the initial speed of one atom will be the same as the final speed of the other atom.
  - B the relative speed of approach between the two atoms equals their relative speed of separation.
  - C the total momentum must be conserved, but a small amount of the total kinetic energy may be lost in the collision.
  - D whatever their initial states of motion, neither atom can be stationary after the collision.
- 12 Two railway trucks of masses  $m$  and  $3m$  move towards each other in opposite directions with speeds  $2v$  and  $v$  respectively. These trucks collide and stick together.

What is the speed of the trucks after the collision?

- A  $\frac{v}{4}$
  - B  $\frac{v}{2}$
  - C  $v$
  - D  $\frac{5v}{4}$
- 13 The diagrams show three forces acting on a body.

In which diagram is the body in equilibrium?

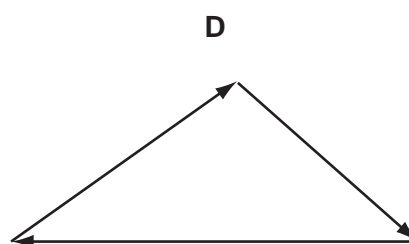
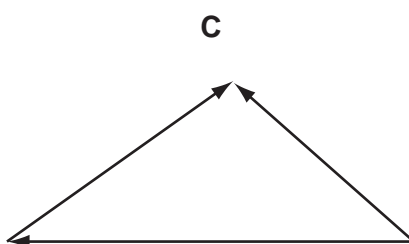
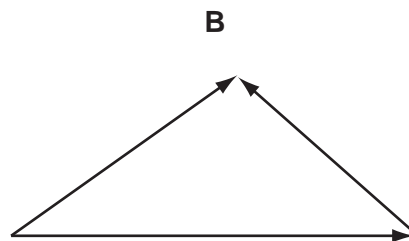
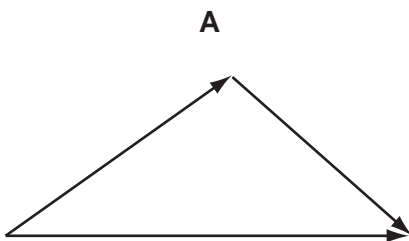



- 14 A force  $F$  is applied to a beam at a distance  $d$  from a pivot. The force acts at an angle  $\theta$  perpendicular to the beam.

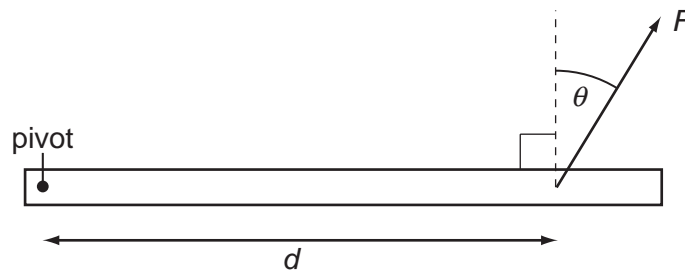

Which combination will cause the largest turning effect about the pivot?

	$F$	$d$	$\theta$
<b>A</b>	large	large	large
<b>B</b>	large	large	small
<b>C</b>	small	small	large
<b>D</b>	small	large	small

- 15 A rigid uniform bar of length 2.4 m is pivoted horizontally at its mid-point.

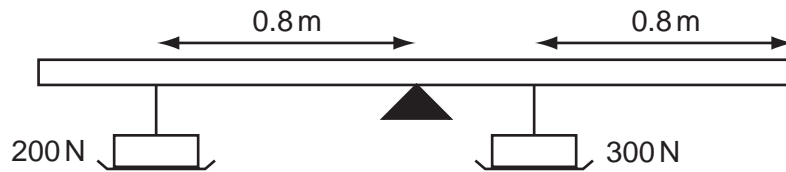

Weights are hung from two points of the bar as shown in the diagram. To maintain horizontal equilibrium, a couple is applied to the bar.

What is the torque and direction of this couple?

- A** 40 N m clockwise  
**B** 40 N m anticlockwise  
**C** 80 N m clockwise  
**D** 80 N m anticlockwise
- 16 What is the internal energy of an object?
- A** It is the energy associated with the object's movement through space.  
**B** It is the energy associated with the random movement of the molecules in the object.  
**C** It is the energy due to the attractions between the molecules within the object.  
**D** It is the sum of all the microscopic potential and kinetic energies of the molecules.

17 A motorist travelling at  $10 \text{ m s}^{-1}$  can bring his car to rest in a braking distance of 10 m.

In what distance could he bring the car to rest from a speed of  $30 \text{ m s}^{-1}$  using the same force?

- A 17 m                      B 30 m                      C 52 m                      D 90 m

18 A stone of weight 4.0 N in the Earth's gravitational field is moved from P to Q and then to R along the path shown.

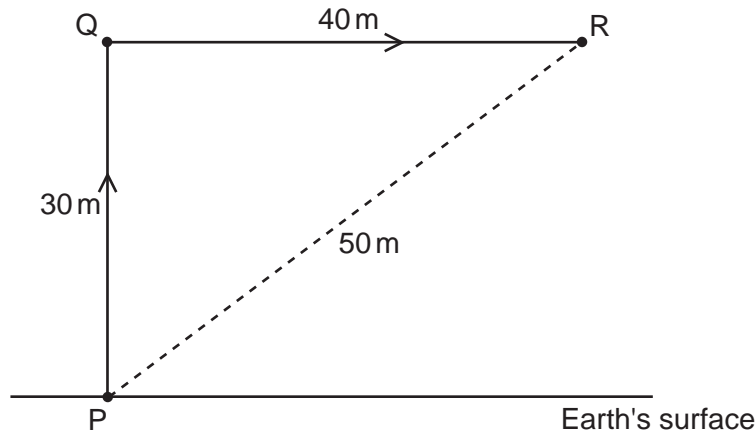

How much potential energy does the stone gain?

- A 120 J                      B 200 J                      C 280 J                      D 1200 J

19 Below are four short paragraphs describing the molecules in a beaker of water at  $50^\circ\text{C}$ .

Which paragraph correctly describes the molecules?

- A The molecules all travel at the same speed. This speed is not large enough for any of the molecules to leave the surface of the water. There are attractive forces between the molecules.
- B The molecules have a range of speeds. Some molecules travel sufficiently fast to leave the surface of the water. There are no forces between the molecules.
- C The molecules have a range of speeds. Some molecules travel sufficiently fast to leave the surface of the water. There are attractive forces between the molecules.
- D The molecules have a range of speeds. The fastest molecules are unable to leave the surface of the water. There are attractive forces between the molecules.

- 20 In an experiment to demonstrate Brownian motion, smoke particles in a container are illuminated by a strong light source and observed through a microscope.

The particles are seen as small specks of light that are in motion.

What causes the Brownian motion?

- A collisions between the smoke particles and air molecules
  - B collisions between the smoke particles and the walls of the container
  - C convection currents within the air as it is warmed by the light source
  - D kinetic energy gained by the smoke particles on absorption of light
- 21 In describing the behaviour of a spring, the spring constant is used.

Different loads are used to extend the spring by different amounts.

To find the spring constant, which quantities are required?

- A the elastic limit and the loads
  - B the elastic limit, extensions and the length of the spring
  - C the loads and the extensions of the spring
  - D the loads and the length of the spring
- 22 The graph shows the behaviour of a sample of a metal when it is stretched until it starts to undergo plastic deformation.

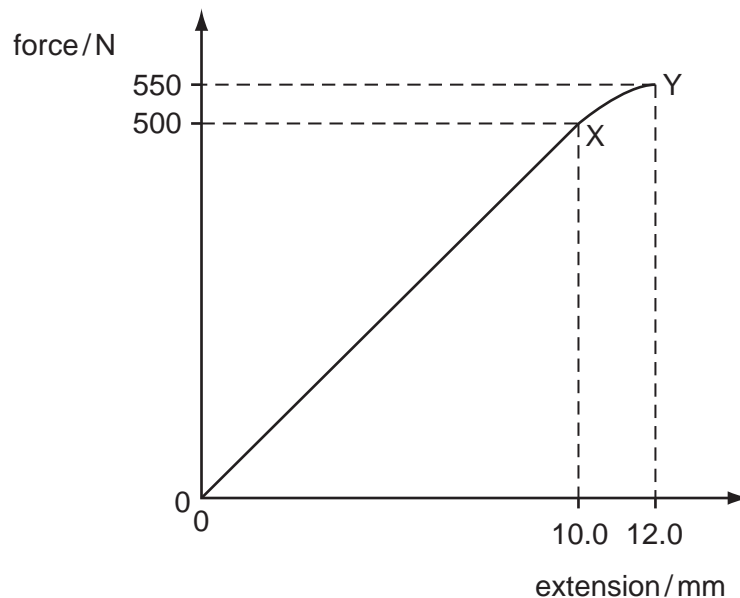

What is the total work done in stretching the sample from zero extension to 12.0 mm? Simplify the calculation by treating the region XY as a straight line.

- A 3.30 J
- B 3.55 J
- C 3.60 J
- D 6.60 J

- 23 Which phenomenon is associated with transverse waves but **not** longitudinal waves?
- A polarisation
  - B reflection
  - C refraction
  - D superposition

24 A displacement-time graph is shown for a particular wave.

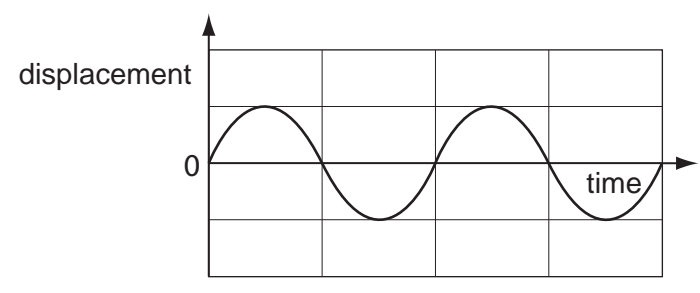

A second wave of similar type has twice the intensity and half the frequency.

When drawn on the same axes, what would the second wave look like?

**A**

**B**

**C**

**D**

25 The frequency of a certain wave is 500 Hz and its speed is 340 ms<sup>-1</sup>.

What is the phase difference between the motions of two points on the wave 0.17 m apart?

- A  $\frac{\pi}{4}$  rad
- B  $\frac{\pi}{2}$  rad
- C  $\frac{3\pi}{4}$  rad
- D  $\pi$  rad

26 Where, in a standing wave, do the vibrations of the medium occur?

- A only at the nodes
- B only at the antinodes
- C at all points between the nodes
- D at all points between the antinodes

27 Monochromatic light is incident on a diffraction grating and a diffraction pattern is observed.

Which line of the table gives the effect of replacing the grating with one that has more lines per metre?

	number of orders of diffraction visible	angle between first and second orders of diffraction
<b>A</b>	decreases	decreases
<b>B</b>	decreases	increases
<b>C</b>	increases	decreases
<b>D</b>	increases	increases

28 A double-slit interference experiment is set up as shown.

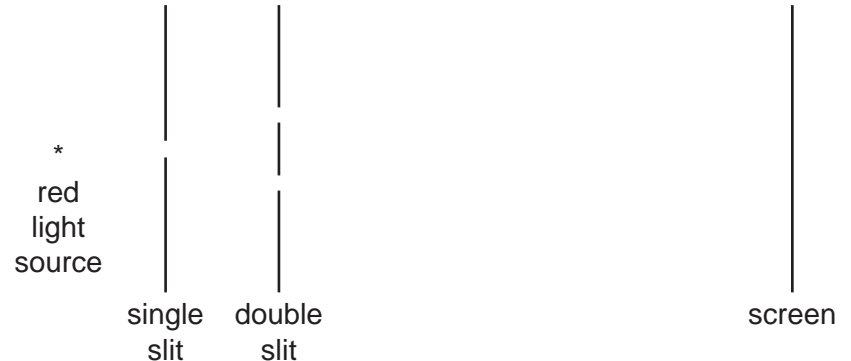

not to scale

Fringes are formed on the screen. The distance between successive bright fringes is found to be 4 mm.

Two changes are then made to the experimental arrangement. The double slit is replaced by another double slit which has half the spacing. The screen is moved so that its distance from the double slit is twice as great.

What is now the distance between successive bright fringes?

- A 1mm
- B 4mm
- C 8mm
- D 16mm

29 Two parallel metal plates are at potentials of +800 V and +1300 V.

Which diagram best shows the electric field between the metal plates?

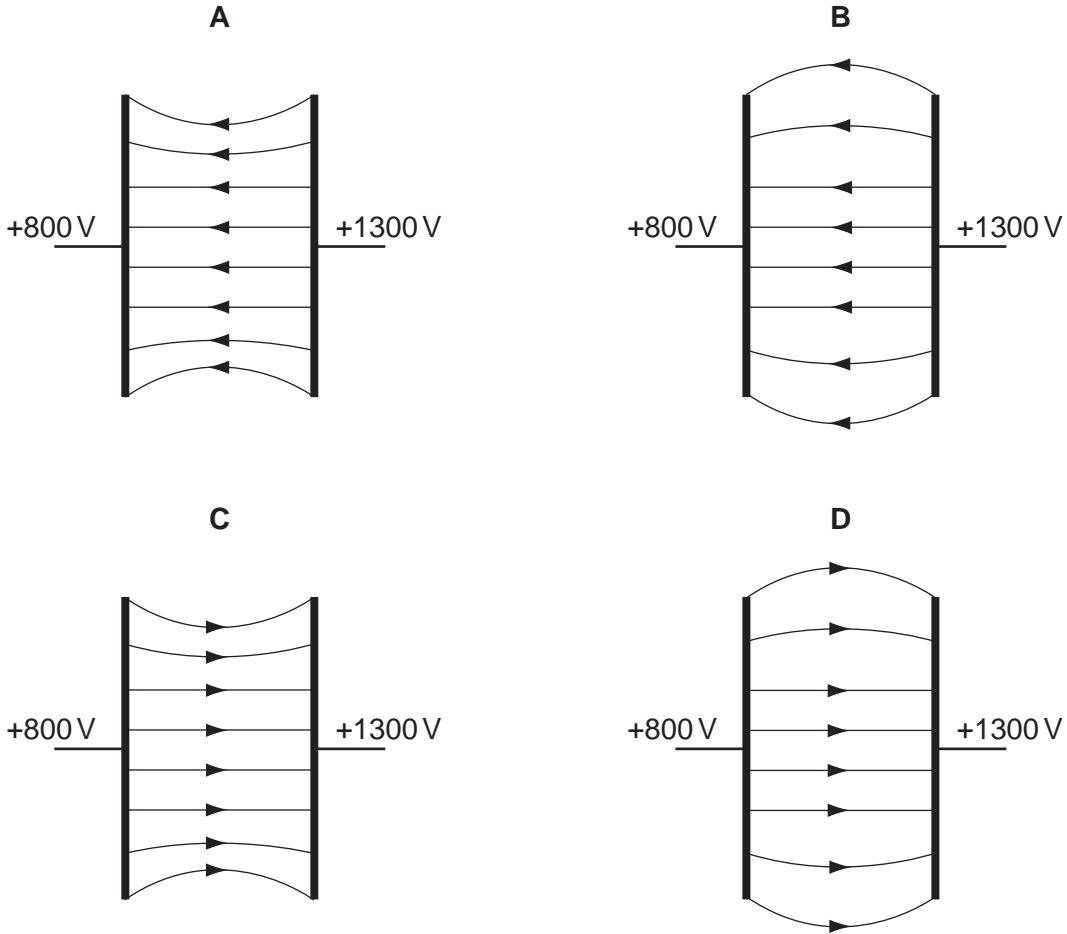

30 An electron of charge  $e$  is introduced between two metal plates a distance  $d$  apart.

A potential difference  $V$  is applied to the plates as shown in the diagram.

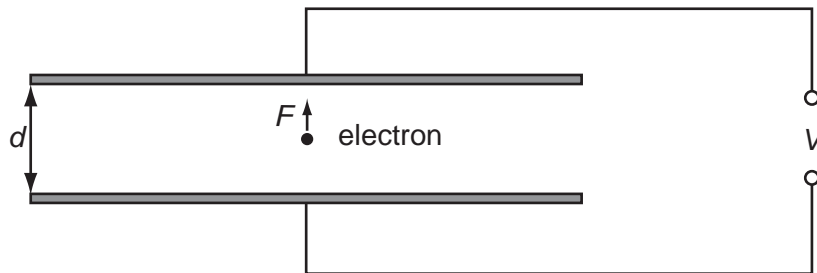

Which expression gives the electric force  $F$  on the electron?

- A  $\frac{eV}{d}$       B  $eVd$       C  $\frac{V}{ed}$       D  $\frac{dV}{e}$

15

31 The current in the circuit is 4.8 A.

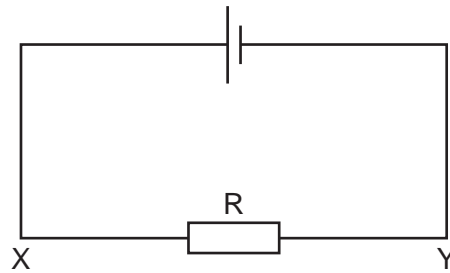

What is the rate of flow and the direction of flow of electrons through the resistor R?

- A**  $3.0 \times 10^{19} \text{ s}^{-1}$  in direction X to Y
- B**  $6.0 \times 10^{18} \text{ s}^{-1}$  in direction X to Y
- C**  $3.0 \times 10^{19} \text{ s}^{-1}$  in direction Y to X
- D**  $6.0 \times 10^{18} \text{ s}^{-1}$  in direction Y to X
- 32 Which equation is used to define resistance?
- A** energy = (current)<sup>2</sup> × resistance × time
- B** potential difference = current × resistance
- C** power = (current)<sup>2</sup> × resistance
- D** resistivity = resistance × area ÷ length
- 33 A p.d. of 12 V is connected between P and Q.

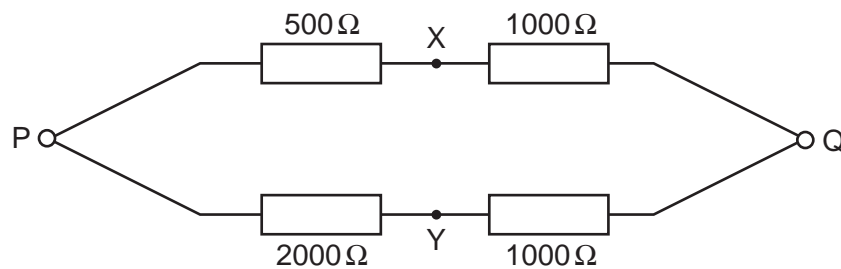

What is the p.d. between X and Y?

- A** 0 V                      **B** 4 V                      **C** 6 V                      **D** 8 V

16

- 34 The diagram shows a low-voltage circuit for heating the water in a fish tank.

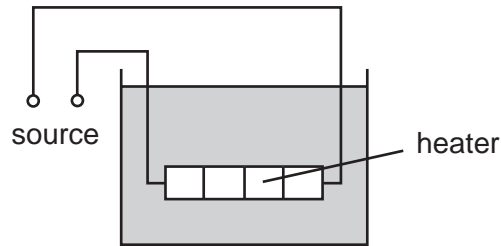

The heater has a resistance of  $3.0\ \Omega$ . The voltage source has an e.m.f. of  $12\ \text{V}$  and an internal resistance of  $1.0\ \Omega$ .

At what rate does the voltage source supply energy to the heater?

- A  $27\ \text{W}$       B  $36\ \text{W}$       C  $48\ \text{W}$       D  $64\ \text{W}$
- 35 The diagram shows an arrangement of resistors.

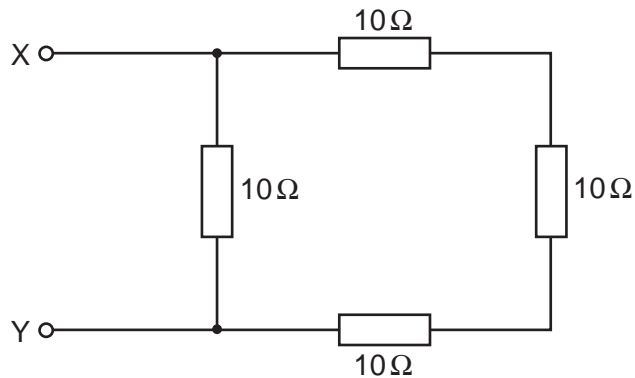

What is the total electrical resistance between X and Y?

- A less than  $1\ \Omega$   
 B between  $1\ \Omega$  and  $10\ \Omega$   
 C between  $10\ \Omega$  and  $30\ \Omega$   
 D  $40\ \Omega$



36 When four identical lamps P, Q, R and S are connected as shown in diagram 1, they have the same brightness.

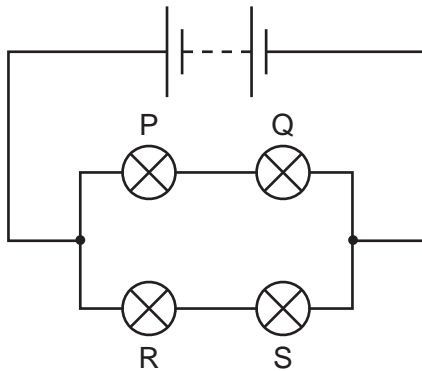

diagram 1

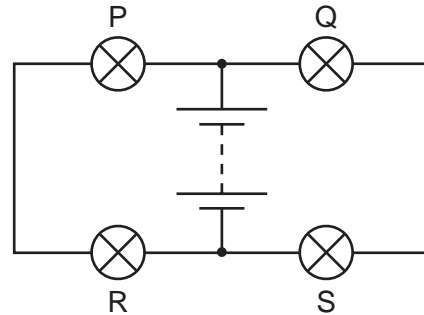

diagram 2

The four lamps and the battery are then connected as shown in diagram 2.

Which statement is correct?

- A The lamps do not light.
- B The lamps are less bright than normal.
- C The lamps have normal brightness.
- D The lamps are brighter than normal.

37 The diagram shows a light-dependent resistor (LDR) and a thermistor forming a potential divider.

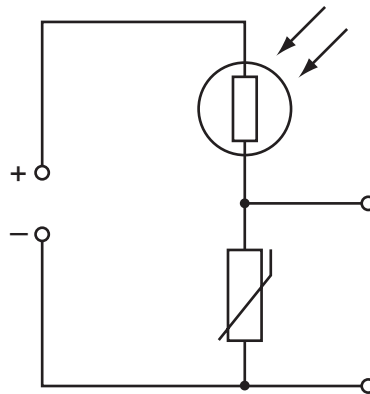

Under which set of conditions will the potential difference across the thermistor have the greatest value?

	illumination	temperature
<b>A</b>	low	low
<b>B</b>	high	low
<b>C</b>	low	high
<b>D</b>	high	high

- 38 What is a correct order of magnitude estimate for the diameter of a typical atomic nucleus?
- A  $10^{-14}$  m      B  $10^{-18}$  m      C  $10^{-22}$  m      D  $10^{-26}$  m
- 39 The decay of a nucleus of neptunium is accompanied by the emission of a  $\beta$ -particle and  $\gamma$ -radiation.

What effect (if any) does this decay have on the proton number and the nucleon number of the nucleus?

	proton number	nucleon number
<b>A</b>	increases	decreases
<b>B</b>	decreases	increases
<b>C</b>	unchanged	decreases
<b>D</b>	increases	unchanged

- 40 Radon-220 is radioactive and decays to Polonium-216 with the emission of an  $\alpha$ -particle. The equation for the radioactive decay is shown.

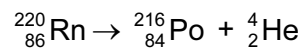

How many neutrons are in the radon and polonium nuclei?

	Rn	Po
<b>A</b>	86	84
<b>B</b>	134	132
<b>C</b>	220	212
<b>D</b>	220	216



