



UNIVERSITY OF CAMBRIDGE INTERNATIONAL EXAMINATIONS
General Certificate of Education
Advanced Subsidiary Level and Advanced Level

PHYSICS

9702/01

Paper 1 Multiple Choice

May/June 2007

1 hour

Additional Materials: Multiple Choice Answer Sheet
 Soft clean eraser
 Soft pencil (type B or HB is recommended)



READ THESE INSTRUCTIONS FIRST

Write in soft pencil.

Do not use staples, paper clips, highlighters, glue or correction fluid.

Write your name, Centre number and candidate number on the Answer Sheet in the spaces provided unless this has been done for you.

There are **forty** questions on this paper. Answer **all** questions. For each question there are four possible answers **A, B, C** and **D**.

Choose the **one** you consider correct and record your choice in **soft pencil** on the separate Answer Sheet.

Read the instructions on the Answer Sheet very carefully.

Each correct answer will score one mark. A mark will not be deducted for a wrong answer.

Any rough working should be done in this booklet.

This document consists of **18** printed pages and **2** blank pages.



Data

speed of light in free space,	$c = 3.00 \times 10^8 \text{ m s}^{-1}$
permeability of free space,	$\mu_0 = 4\pi \times 10^{-7} \text{ H m}^{-1}$
permittivity of free space,	$\epsilon_0 = 8.85 \times 10^{-12} \text{ F m}^{-1}$
elementary charge,	$e = 1.60 \times 10^{-19} \text{ C}$
the Planck constant,	$h = 6.63 \times 10^{-34} \text{ J s}$
unified atomic mass constant,	$u = 1.66 \times 10^{-27} \text{ kg}$
rest mass of electron,	$m_e = 9.11 \times 10^{-31} \text{ kg}$
rest mass of proton,	$m_p = 1.67 \times 10^{-27} \text{ kg}$
molar gas constant,	$R = 8.31 \text{ J K}^{-1} \text{ mol}^{-1}$
the Avogadro constant,	$N_A = 6.02 \times 10^{23} \text{ mol}^{-1}$
the Boltzmann constant,	$k = 1.38 \times 10^{-23} \text{ J K}^{-1}$
gravitational constant,	$G = 6.67 \times 10^{-11} \text{ N m}^2 \text{ kg}^{-2}$
acceleration of free fall,	$g = 9.81 \text{ m s}^{-2}$

Formulae

uniformly accelerated motion,	$s = ut + \frac{1}{2} at^2$ $v^2 = u^2 + 2as$
work done on/by a gas,	$W = p\Delta V$
gravitational potential,	$\phi = -\frac{Gm}{r}$
hydrostatic pressure,	$p = \rho gh$
pressure of an ideal gas,	$p = \frac{1}{3} \frac{Nm}{V} \langle c^2 \rangle$
simple harmonic motion,	$a = -\omega^2 x$
velocity of particle in s.h.m.,	$v = v_0 \cos \omega t$ $v = \pm \omega \sqrt{(x_0^2 - x^2)}$
electric potential,	$V = \frac{Q}{4\pi\epsilon_0 r}$
capacitors in series,	$1/C = 1/C_1 + 1/C_2 + \dots$
capacitors in parallel,	$C = C_1 + C_2 + \dots$
energy of charged capacitor,	$W = \frac{1}{2} QV$
resistors in series,	$R = R_1 + R_2 + \dots$
resistors in parallel,	$1/R = 1/R_1 + 1/R_2 + \dots$
alternating current/voltage,	$x = x_0 \sin \omega t$
radioactive decay,	$x = x_0 \exp(-\lambda t)$
decay constant,	$\lambda = \frac{0.693}{t_{\frac{1}{2}}}$

1 Which is a pair of SI base units?

A	ampere	joule
B	coulomb	second
C	kilogram	kelvin
D	metre	newton

2 What is the ratio $\frac{1\mu\text{m}}{1\text{Gm}}$?

A 10^{-3}

B 10^{-9}

C 10^{-12}

D 10^{-15}

3 Which formula could be correct for the speed v of ocean waves in terms of the density ρ of sea-water, the acceleration of free fall g , the depth h of the ocean and the wavelength λ ?

A $v = \sqrt{g\lambda}$

B $v = \sqrt{\frac{g}{h}}$

C $v = \sqrt{\rho gh}$

D $v = \sqrt{\frac{g}{\rho}}$

- 4 An oscilloscope display consists of two separate traces, a waveform and a long horizontal line. The horizontal line may be taken as the zero level.

The grid on the screen is calibrated in cm squares, the timebase setting is 2.5 ms cm^{-1} , and the Y-sensitivity is 5 mV cm^{-1} .

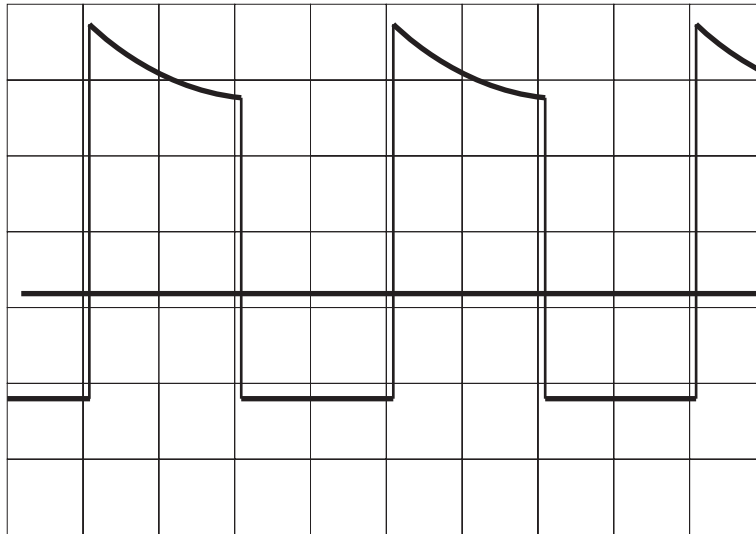

What are the period and the peak positive voltage of the waveform in the diagram?

	period / ms	peak positive voltage / mV
A	5	17
B	5	25
C	10	17
D	10	25

- 5 The resistance of an electrical component is measured. The following meter readings are obtained.

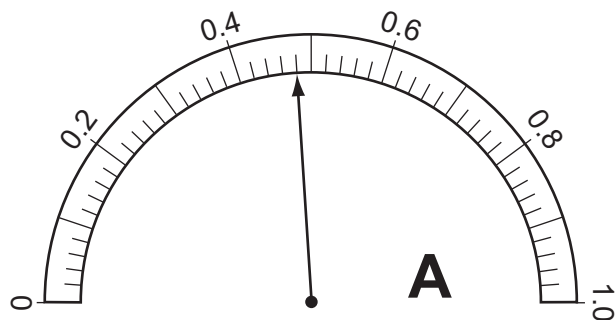

What is the resistance?

- A** 2.5Ω **B** 2.7Ω **C** 2500Ω **D** 2700Ω

- 6 What gives the value of a body's acceleration?
- A the area under its displacement-time graph
 - B the area under its velocity-time graph
 - C the gradient of its displacement-time graph
 - D the gradient of its velocity-time graph
- 7 An object has an initial velocity u . It is subjected to a constant force F for t seconds, causing a constant acceleration a . The force is **not** in the same direction as the initial velocity.

A vector diagram is drawn to find the final velocity v .

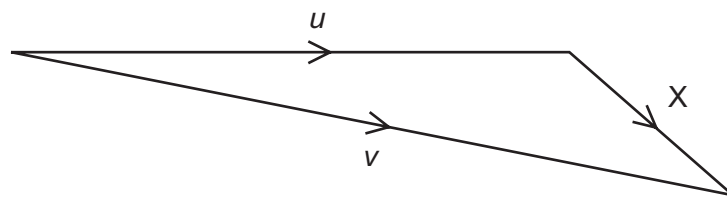

What is the length of side X of the vector diagram?

- A F
 - B Ft
 - C at
 - D $u + at$
- 8 A stone is dropped from the top of a tower of height 40 m. The stone falls from rest and air resistance is negligible.
- What time is taken for the stone to fall the last 10 m to the ground?
- A 0.38 s
 - B 1.4 s
 - C 2.5 s
 - D 2.9 s
- 9 What is meant by the weight of an object?
- A the gravitational field acting on the object
 - B the gravitational force acting on the object
 - C the mass of the object multiplied by gravity
 - D the object's mass multiplied by its acceleration

- 10 The graph shows the variation with time of the momentum of a ball as it is kicked in a straight line.

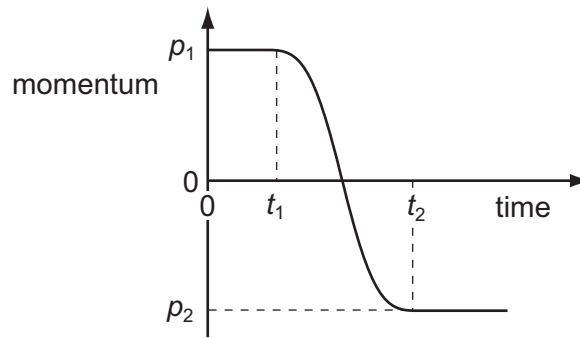

Initially, the momentum is p_1 at time t_1 . At time t_2 the momentum is p_2 .

What is the magnitude of the average force acting on the ball between times t_1 and t_2 ?

- A $\frac{p_1 - p_2}{t_2}$ B $\frac{p_1 - p_2}{t_2 - t_1}$ C $\frac{p_1 + p_2}{t_2}$ D $\frac{p_1 + p_2}{t_2 - t_1}$
- 11 A lorry of mass 20 000 kg is travelling at 20.0 m s^{-1} . A car of mass 900 kg is travelling at 30.0 m s^{-1} towards the lorry.

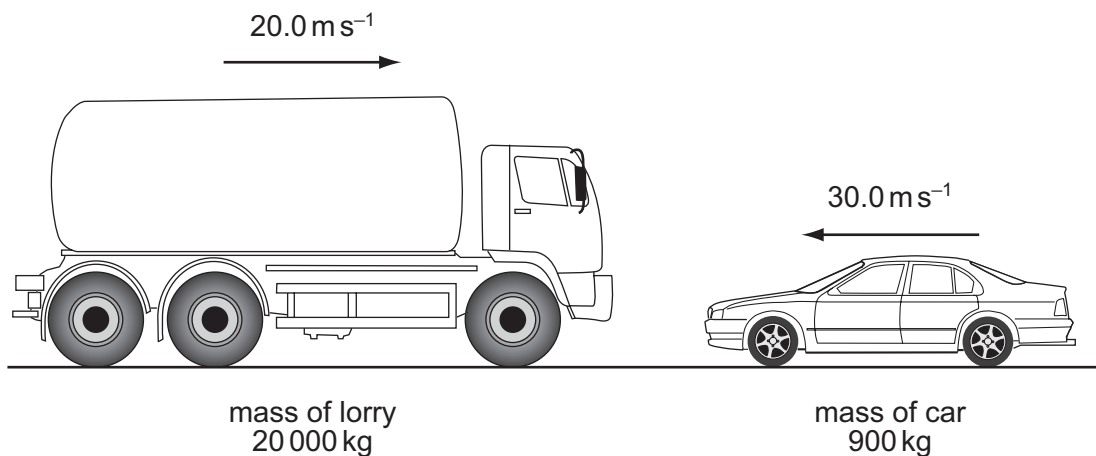

What is the magnitude of the total momentum?

- A 209 kNs B 373 kNs C 427 kNs D 1045 kNs

- 12 The diagram shows the masses and velocities of two trolleys about to collide.



After the impact they move off together.

What is the total kinetic energy of the trolleys after the collision?

- A 1.3 J B 12 J C 18 J D 19 J
- 13 Two 8.0 N forces act at each end of a beam of length 0.60 m. The forces are parallel and act in opposite directions. The angle between the forces and the beam is 60°.

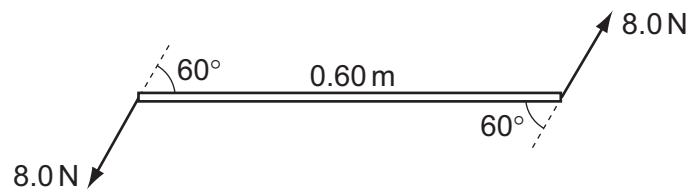

What is the torque of the couple exerted on the beam?

- A 2.4 Nm B 4.2 Nm C 4.8 Nm D 9.6 Nm
- 14 Which expression **defines** power?
- A force \times distance moved in the direction of the force
- B force \times velocity
- C work done \div time taken
- D work done \times time taken
- 15 The density of mercury is $13.6 \times 10^3 \text{ kg m}^{-3}$.

The pressure difference between the bottom and the top of a column of mercury is 100 kPa.

What is the height of the column?

- A 0.75 m B 1.3 m C 7.4 m D 72 m

16 Which group of statements applies only to the liquid state?

A

atoms separated by many atomic diameters
positions of atoms can change
atoms vibrate

B

atoms separated by many atomic diameters
atoms are in fixed positions
atoms are in continuous, random motion

C

atoms can touch each other
positions of atoms can change
some random motion of atoms

D

atoms can touch each other
atoms are in fixed positions
some random motion of atoms

17 A piece of copper is drawn into a continuous wire.

What behaviour is the copper exhibiting?

- A** brittle only
- B** elastic only
- C** plastic only
- D** both brittle and elastic

18 The force-extension graph of a particular sample of rubber as a load is applied and then removed is shown.

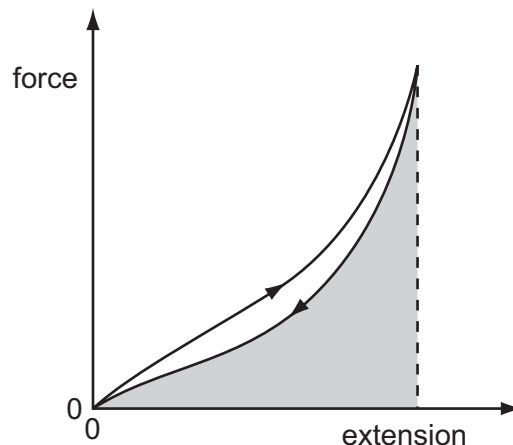

What does the shaded area represent?

- A** the energy transformed into heat during the complete cycle
- B** the recoverable elastic potential energy stored at maximum extension
- C** the work done on the sample while loading
- D** the work done on the sample while unloading

- 19 A spring of unextended length 0.50 m is stretched by a force of 2.0 N to a new length of 0.90 m. The variation of its length with tension is as shown.

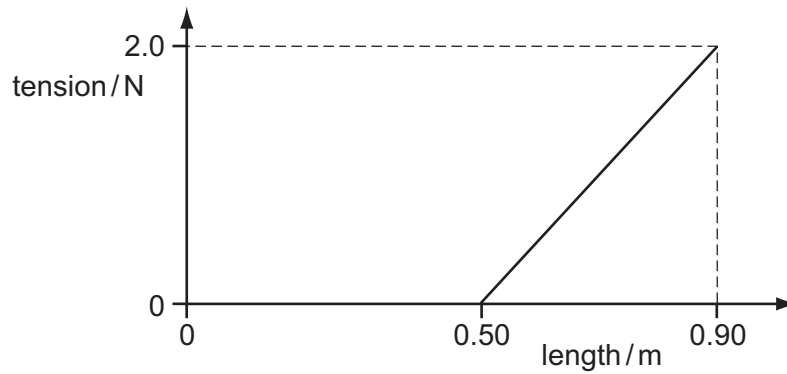

How much strain energy is stored in the spring?

- A 0.40 J B 0.80 J C 0.90 J D 1.8 J
- 20 A simple crane consists of a rigid vertical pillar supporting a horizontal beam.

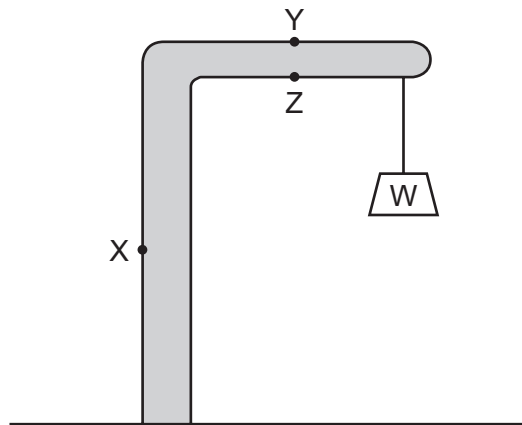

A weight W is lifted by a rope at the end of the beam.

What are the forces at points X , Y and Z due to the weight W ?

	force at X	force at Y	force at Z
A	tension	compression	tension
B	tension	tension	compression
C	compression	tension	compression
D	compression	compression	compression

21 Which of the following types of wave can be polarised?

- A a longitudinal progressive wave
- B a longitudinal stationary wave
- C a transverse stationary wave
- D a transverse sound wave

22 Sound wave X has intensity 10^{12} times greater than that of sound wave Y.

By how much is the amplitude of X greater than the amplitude of Y?

- A 10^6 times
- B 3.16×10^6 times
- C 5×10^{11} times
- D 10^{12} times

23 The graph shows the shape at a particular instant of part of a transverse wave travelling along a string.

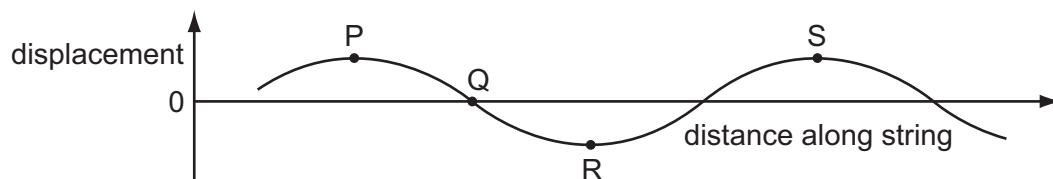

Which statement about the motion of points in the string is correct?

- A The speed at point P is a maximum.
- B The displacement at point Q is always zero.
- C The energy at point R is entirely kinetic.
- D The acceleration at point S is a maximum.

24 The diagram illustrates part of the electromagnetic spectrum.

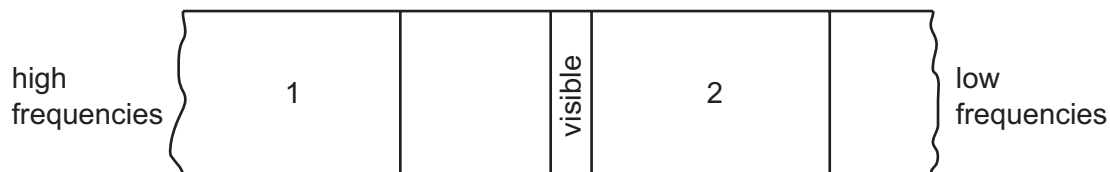

Which labels are correct for the regions marked 1 and 2?

	1	2
A	infrared	X-rays
B	microwaves	X-rays
C	ultraviolet	microwaves
D	X-rays	infrared

25 The diagram represents a stationary wave on a stretched string.

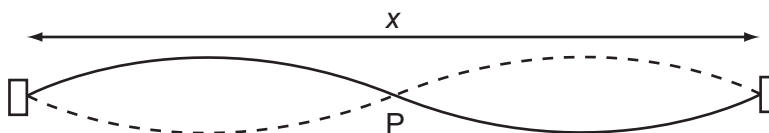

What is represented by point P and by the length x?

	point P	length x
A	antinode	one wavelength
B	antinode	two wavelengths
C	node	one wavelength
D	node	two wavelengths

26 A two-slit arrangement is set up to produce interference fringes on a screen. The fringes are too close together for convenient observation when a monochromatic source of violet light is used.

In which way would it be possible to increase the separation of the fringes?

- A** Decrease the distance between the screen and the slits.
- B** Increase the distance between the two slits.
- C** Increase the width of each slit.
- D** Use a monochromatic source of red light.

- 27 A stationary longitudinal wave is set up in a pipe.

In the diagrams below, the length of each arrow represents the amplitude of the motion of the air molecules, and the arrow head shows the direction of motion at a particular instant.

Which diagram shows a stationary wave in which there are two nodes and two antinodes?

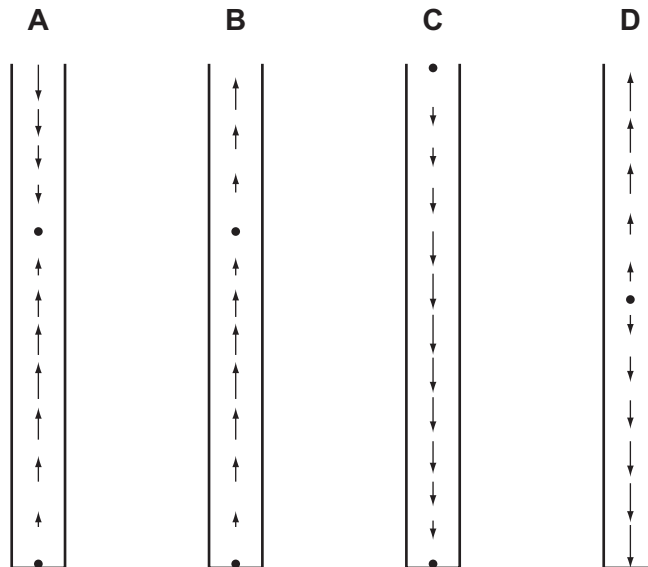

- 28 Which diagram represents the electric field of a negative point charge, shown by ● ?

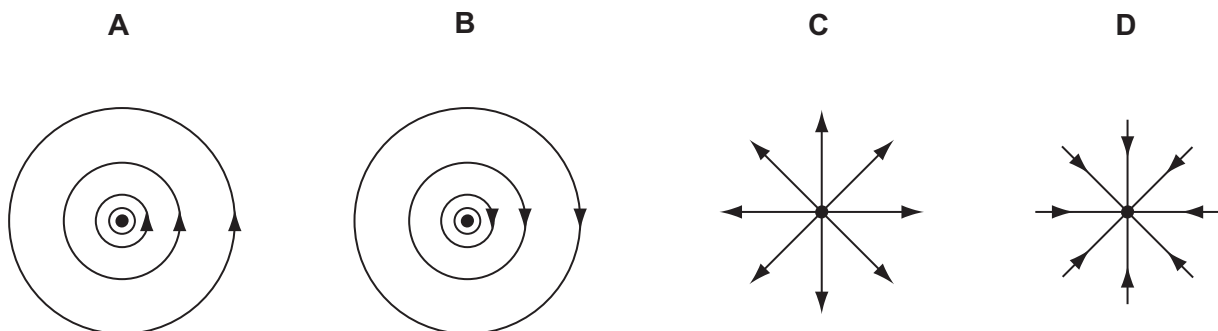

- 29 An electron, travelling horizontally at constant speed in a vacuum, enters a vertical electric field between two charged parallel plates as shown.

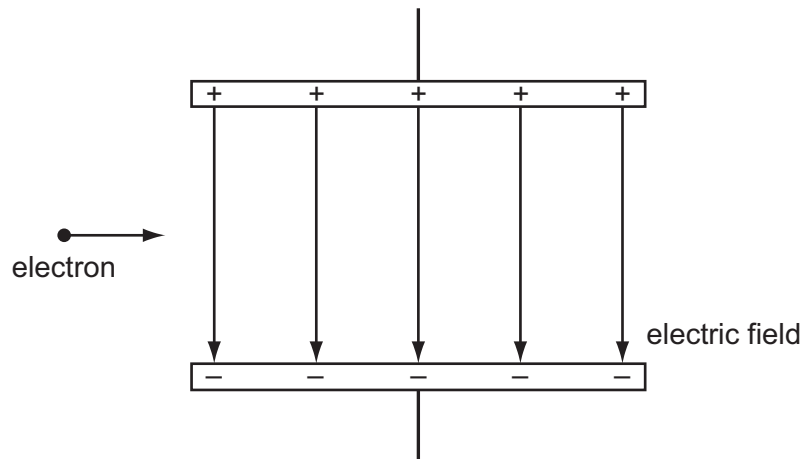

What are the horizontal and vertical components of the motion of this electron when it is in the field?

	horizontal component of motion	vertical component of motion
A	constant speed	acceleration upwards
B	constant speed	acceleration downwards
C	acceleration to the right	acceleration downwards
D	acceleration to the right	acceleration upwards

- 30 The electric field strength between a pair of parallel plates is E . The separation of the plates is doubled and the potential difference between the plates is increased by a factor of four.

What is the new electric field strength?

- A** E **B** $2E$ **C** $4E$ **D** $8E$
- 31 What is a correct statement of Ohm's law?
- A** The potential difference across a component equals the current providing the resistance and other physical conditions stay constant.
- B** The potential difference across a component equals the current multiplied by the resistance.
- C** The potential difference across a component is proportional to its resistance.
- D** The potential difference across a component is proportional to the current in it providing physical conditions stay constant.

32 The current in a resistor is 8.0 mA.

What charge flows through the resistor in 0.020 s?

- A 0.16 mC B 1.6 mC C 4.0 mC D 0.40 C

33 A cell of e.m.f. 2.0 V and negligible internal resistance is connected to the network of resistors shown.

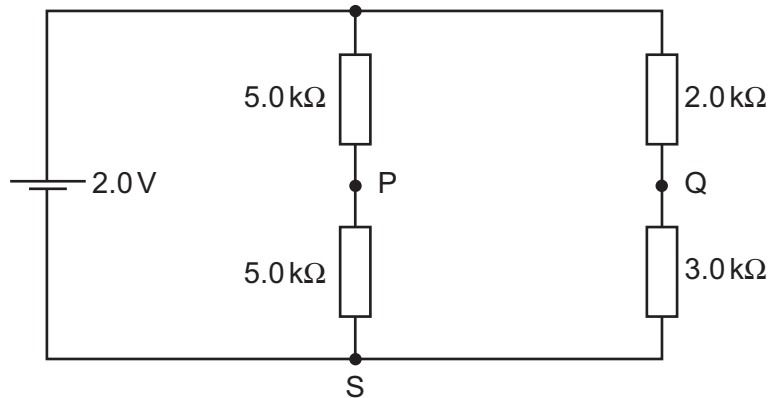

V_1 is the potential difference between S and P. V_2 is the potential difference between S and Q.

What is the value of $V_1 - V_2$?

- A +0.50 V B +0.20 V C -0.20 V D -0.50 V

34 A circuit is set up with an LDR and a fixed resistor as shown.

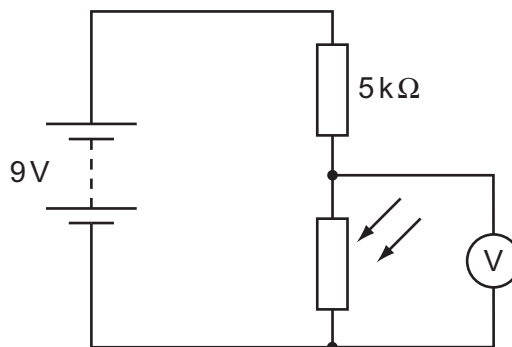

The voltmeter reads 4 V.

The light intensity is increased.

What is a possible voltmeter reading?

- A 3 V B 4 V C 6 V D 8 V

- 35 In the circuit below, the battery converts an amount E of chemical energy to electrical energy when charge Q passes through the resistor in time t .

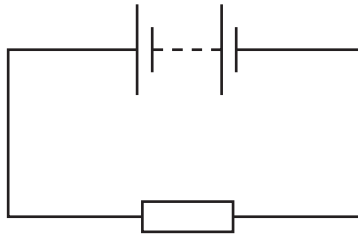

Which expressions give the e.m.f. of the battery and the current in the resistor?

	e.m.f.	current
A	EQ	Q/t
B	EQ	Qt
C	E/Q	Q/t
D	E/Q	Qt

- 36 A battery has an e.m.f. of 3.0 V and an internal resistance of $2.0\ \Omega$.

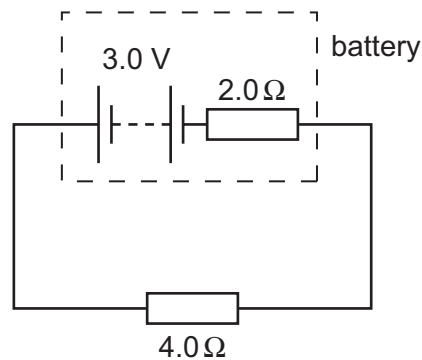

The battery is connected to a load of $4.0\ \Omega$.

What are the terminal potential difference V and output power P ?

	V/V	P/W
A	1.0	0.50
B	1.0	1.5
C	2.0	1.0
D	2.0	1.5

- 37 A researcher has two pieces of copper of the same volume. All of the first piece is made into a cylindrical resistor P of length x .

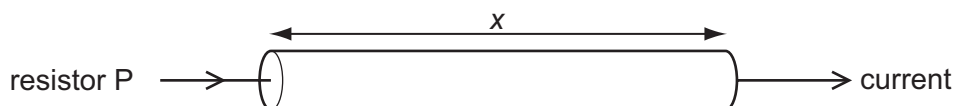

All of the second piece is made into uniform wires each of the same length x which he connects between two bars of negligible resistance to form a resistor Q.

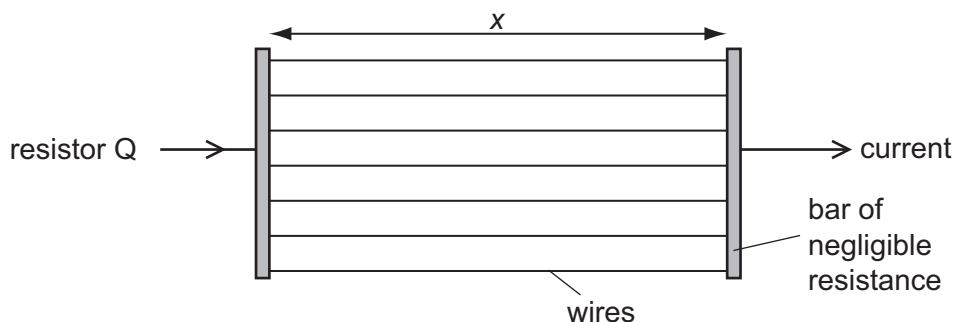

How do the electrical resistances of P and Q compare?

- A P has a larger resistance than Q.
 B Q has a larger resistance than P.
 C P and Q have equal resistance.
 D Q may have a larger or smaller resistance than P, depending on the number of wires made.
- 38 A detector is exposed to a radioactive source. Fluctuations in the count-rate are observed.
- What do these fluctuations indicate about radioactive decay?
- A It is random.
 B It is spontaneous.
 C It is exponential.
 D It is non-linear.
- 39 The symbol ${}^{77}_{32}\text{Ge}$ represents a nucleus of germanium that decays to a nucleus of arsenic by emitting a β -particle.

What is the symbol of this arsenic nucleus?

- A ${}^{76}_{32}\text{As}$ B ${}^{78}_{32}\text{As}$ C ${}^{78}_{31}\text{As}$ D ${}^{77}_{33}\text{As}$

40 Each of the nuclei below is accelerated from rest through the same potential difference.

Which one completes the acceleration with the **lowest** speed?

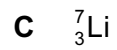
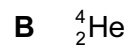
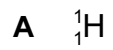

BLANK PAGE

BLANK PAGE

Permission to reproduce items where third-party owned material protected by copyright is included has been sought and cleared where possible. Every reasonable effort has been made by the publisher (UCLES) to trace copyright holders, but if any items requiring clearance have unwittingly been included, the publisher will be pleased to make amends at the earliest possible opportunity.

University of Cambridge International Examinations is part of the Cambridge Assessment Group. Cambridge Assessment is the brand name of University of Cambridge Local Examinations Syndicate (UCLES), which is itself a department of the University of Cambridge.