

Cambridge
International
AS & A Level

Cambridge International Examinations
Cambridge International Advanced Subsidiary and Advanced Level

PHYSICS

9702/12

Paper 1 Multiple Choice

February/March 2018

1 hour 15 minutes

Additional Materials: Multiple Choice Answer Sheet
Soft clean eraser
Soft pencil (type B or HB is recommended)

* 3 3 3 1 7 9 3 2 3 1 *

READ THESE INSTRUCTIONS FIRST

Write in soft pencil.

Do not use staples, paper clips, glue or correction fluid.

Write your name, Centre number and candidate number on the Answer Sheet in the spaces provided unless this has been done for you.

DO NOT WRITE IN ANY BARCODES.

There are **forty** questions on this paper. Answer **all** questions. For each question there are four possible answers **A, B, C** and **D**.

Choose the **one** you consider correct and record your choice in **soft pencil** on the separate Answer Sheet.

Read the instructions on the Answer Sheet very carefully.

Each correct answer will score one mark. A mark will not be deducted for a wrong answer.

Any working should be done in this booklet.

Electronic calculators may be used.

This document consists of **19** printed pages and **1** blank page.

Data

speed of light in free space	$c = 3.00 \times 10^8 \text{ m s}^{-1}$
permeability of free space	$\mu_0 = 4\pi \times 10^{-7} \text{ H m}^{-1}$
permittivity of free space	$\epsilon_0 = 8.85 \times 10^{-12} \text{ F m}^{-1}$ $(\frac{1}{4\pi\epsilon_0} = 8.99 \times 10^9 \text{ m F}^{-1})$
elementary charge	$e = 1.60 \times 10^{-19} \text{ C}$
the Planck constant	$h = 6.63 \times 10^{-34} \text{ J s}$
unified atomic mass unit	$1 \text{ u} = 1.66 \times 10^{-27} \text{ kg}$
rest mass of electron	$m_e = 9.11 \times 10^{-31} \text{ kg}$
rest mass of proton	$m_p = 1.67 \times 10^{-27} \text{ kg}$
molar gas constant	$R = 8.31 \text{ J K}^{-1} \text{ mol}^{-1}$
the Avogadro constant	$N_A = 6.02 \times 10^{23} \text{ mol}^{-1}$
the Boltzmann constant	$k = 1.38 \times 10^{-23} \text{ J K}^{-1}$
gravitational constant	$G = 6.67 \times 10^{-11} \text{ N m}^2 \text{ kg}^{-2}$
acceleration of free fall	$g = 9.81 \text{ m s}^{-2}$

Formulae

uniformly accelerated motion	$s = ut + \frac{1}{2}at^2$ $v^2 = u^2 + 2as$
work done on/by a gas	$W = p\Delta V$
gravitational potential	$\phi = -\frac{Gm}{r}$
hydrostatic pressure	$p = \rho gh$
pressure of an ideal gas	$p = \frac{1}{3}\frac{Nm}{V}\langle c^2 \rangle$
simple harmonic motion	$a = -\omega^2 x$
velocity of particle in s.h.m.	$v = v_0 \cos \omega t$ $v = \pm \omega \sqrt{(x_0^2 - x^2)}$
Doppler effect	$f_o = \frac{f_s v}{v \pm v_s}$
electric potential	$V = \frac{Q}{4\pi\epsilon_0 r}$
capacitors in series	$1/C = 1/C_1 + 1/C_2 + \dots$
capacitors in parallel	$C = C_1 + C_2 + \dots$
energy of charged capacitor	$W = \frac{1}{2}QV$
electric current	$I = Anvq$
resistors in series	$R = R_1 + R_2 + \dots$
resistors in parallel	$1/R = 1/R_1 + 1/R_2 + \dots$
Hall voltage	$V_H = \frac{BI}{ntq}$
alternating current/voltage	$x = x_0 \sin \omega t$
radioactive decay	$x = x_0 \exp(-\lambda t)$
decay constant	$\lambda = \frac{0.693}{t_{\frac{1}{2}}}$

1 Which unit is equivalent to the coulomb?

- A ampere per second
- B joule per volt
- C watt per ampere
- D watt per volt

2 Which row shows a quantity and an **incorrect** unit?

	quantity	unit
A	efficiency	no unit
B	moment of force	N m^{-1}
C	momentum	N s
D	work done	J

3 Two forces of equal magnitude are represented by two coplanar vectors. One is directed towards the east and the other is directed towards the north.

What is the direction of a single force that will balance these two forces?

- A towards the north-east
- B towards the north-west
- C towards the south-east
- D towards the south-west

4 The density of paper is 800 kg m^{-3} . A typical sheet of paper has a width of 210 mm and a length of 300 mm.

The thickness of a pack of 500 sheets of paper is 50 mm.

What is the mass of a single sheet of paper?

- A 0.5g
- B 5g
- C 50g
- D 500g

- 5 A person calculates the potential difference across a wire by using the measurements shown.

Which measured quantity has the greatest contribution to the percentage uncertainty in the calculated potential difference?

	quantity	value	uncertainty
A	current / A	5.0	± 0.5
B	diameter of wire / mm	0.8	± 0.1
C	length of wire / m	150	± 5
D	resistivity of metal in wire / $\Omega \text{ m}$	1.6×10^{-8}	$\pm 0.2 \times 10^{-8}$

- 6 A cathode-ray oscilloscope (c.r.o.) is connected to an alternating voltage. The following trace is produced on the screen.

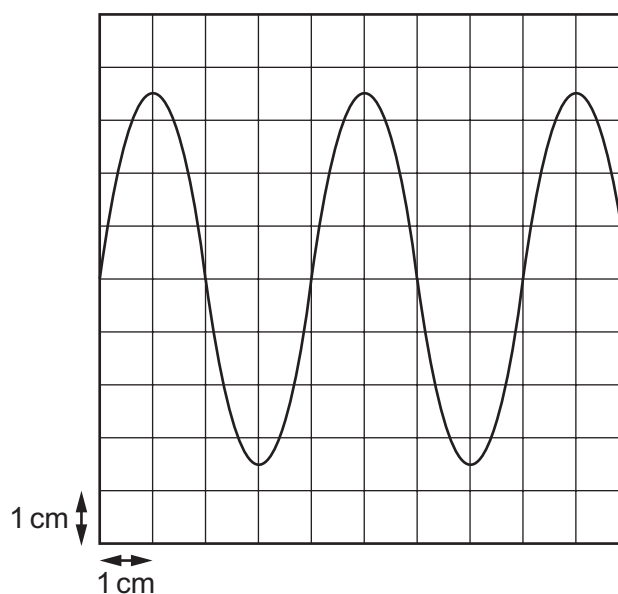

The oscilloscope time-base setting is 0.5 ms cm^{-1} and the Y-plate sensitivity is 2 V cm^{-1} .

Which statement about the alternating voltage is correct?

- A** The amplitude is 3.5 cm.
- B** The frequency is 0.5 kHz.
- C** The period is 1 ms.
- D** The wavelength is 4 cm.

- 7 A stone of mass m is dropped from a tall building. There is significant air resistance. The acceleration of free fall is g .

When the stone is falling at a constant (terminal) velocity, which information is correct?

	magnitude of the acceleration of the stone	magnitude of the force of gravity on the stone	magnitude of the force of air resistance on the stone
A	g	zero	mg
B	zero	mg	mg
C	zero	zero	mg
D	zero	mg	zero

- 8 The velocity-time graph for an object is shown.

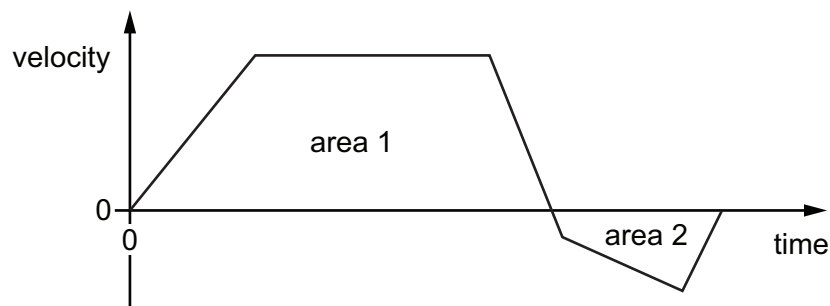

How can the total displacement of the object be determined?

- A** area 1 – area 2
B $\frac{(\text{area 1} + \text{area 2})}{2}$
C area 1 + area 2
D area 2 – area 1
- 9 A girl throws a ball vertically upwards. It takes a time of 3.20 s to return to her hand. Assume air resistance is negligible.
- What is the initial speed with which the ball is thrown?
- A** 3.07 ms^{-1} **B** 7.85 ms^{-1} **C** 15.7 ms^{-1} **D** 31.4 ms^{-1}

- 10 Steel pellets, each with a mass of 0.60 g, fall vertically onto a horizontal plate at a rate of 100 pellets per minute. They strike the plate with a velocity of 5.0 m s^{-1} and rebound with a velocity of 4.0 m s^{-1} .

What is the average force exerted on the plate by the pellets?

- A 0.0010 N B 0.0054 N C 0.0090 N D 0.54 N
- 11 The diagram shows four forces applied to a circular object.

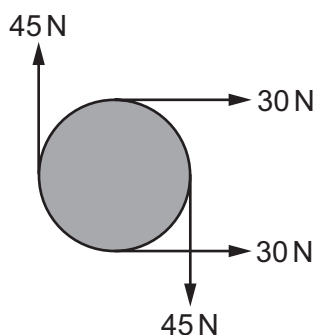

Which row describes the resultant force and resultant torque on the object?

	resultant force	resultant torque
A	non-zero	non-zero
B	non-zero	zero
C	zero	non-zero
D	zero	zero

- 12 A charged oil drop is held stationary between two charged parallel plates.

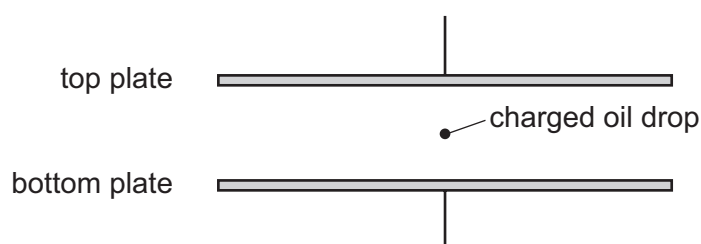

Which forces act on the oil drop?

- A both electric and gravitational
 B electric only
 C gravitational only
 D neither electric nor gravitational

13 In which example is it **not** possible for the underlined body to be in equilibrium?

- A An aeroplane climbs at a steady rate.
- B An aeroplane tows a glider at a constant altitude.
- C A speedboat changes direction at a constant speed.
- D Two boats tow a ship into harbour.

14 A car of mass 1100 kg is travelling at a constant speed of 15 m s^{-1} up a slope inclined at 10° to the horizontal. The combined frictional forces acting on the car are directed down the slope and are equal to $\frac{W}{5}$, where W is the weight of the car.

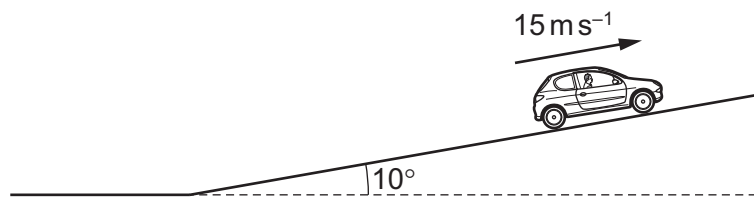

What is the useful output power of the car's engine?

- A 28 kW B 32 kW C 60 kW D 190 kW

15 An old-fashioned 60 W lamp converts 95% of its energy supply into heat. A 4.0 W modern lamp has the same power output of light as the old-fashioned lamp.

What is the efficiency of the modern lamp?

- A 5.0% B 6.7% C 75% D 95%

- 16 A bead is released from rest at point P and slides along a wire, as shown.

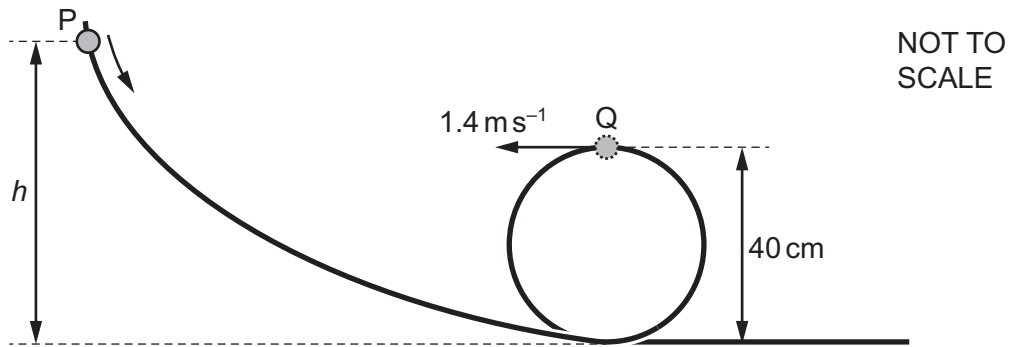

The track loops around and forms a vertical circle of diameter 40 cm. At point Q, the bead has a speed of 1.4 ms^{-1} .

Air resistance and friction on the wire are negligible.

What is the height h from which the bead is released?

- A** 0.30 m **B** 0.40 m **C** 0.50 m **D** 0.60 m
- 17 A small diesel engine uses a volume of $1.5 \times 10^4 \text{ cm}^3$ of fuel per hour to produce a useful power output of 40 kW. It may be assumed that 34 kJ of energy is transferred to the engine when it uses 1.0 cm^3 of fuel.

What is the rate of transfer from the engine of energy that is wasted?

- A** 102 kW **B** 142 kW **C** 182 kW **D** 470 kW

- 18 Two boxes X and Y have the same mass. Box X is lifted vertically through a height h by a force of magnitude F .

Box Y is pulled along a slope by a force of the same magnitude to reach the same height, as shown.

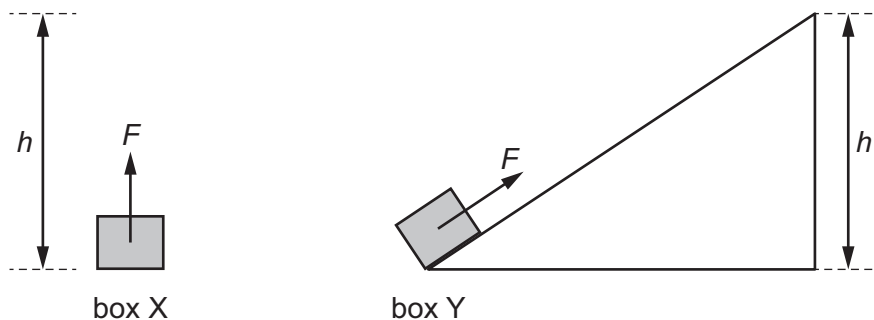

Which statement is correct?

- A** Both boxes gain the same amount of gravitational potential energy and the same amount of work is done by the two forces.
- B** Both boxes gain the same amount of gravitational potential energy but more work is done by the force acting on box Y than by the force acting on box X.
- C** Box Y gains less gravitational potential energy than box X because the weight of box Y is less than the weight of box X.
- D** Box Y gains more gravitational potential energy than box X as more work is done by the force acting on box Y than by the force acting on box X.
- 19 The force-extension graph of a metal wire is shown.

At which point on the graph does the metal wire stop obeying Hooke's law?

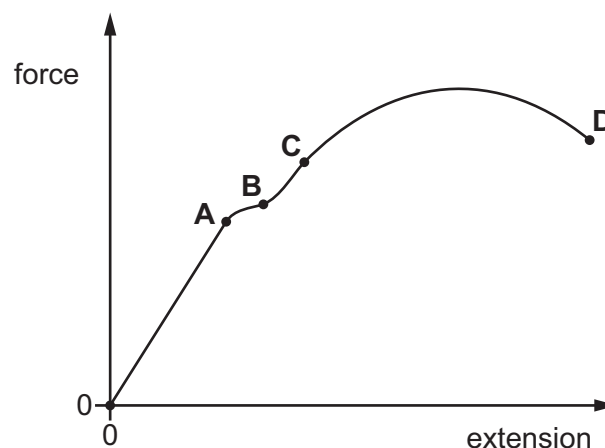

- 20 The diagram shows a large crane on a construction site lifting a cube-shaped load at a constant speed.

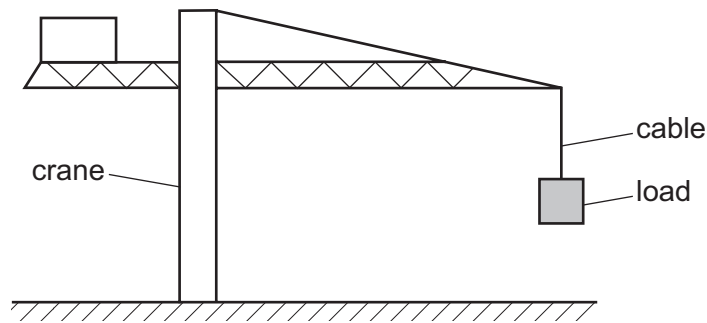

A model is made of the crane, its load and the cable supporting the load.

The material used for each part of the model is the same as that in the full-size crane, cable and load. The model is one tenth full-size in all linear dimensions.

What is the ratio $\frac{\text{stress in the cable on the full-size crane}}{\text{stress in the cable on the model crane}}$?

- A 0.1 B 1 C 10 D 100
- 21 A wave pulse moves along a stretched rope in the direction shown.



Which diagram shows the variation with time t of the displacement s of the particle P in the rope?

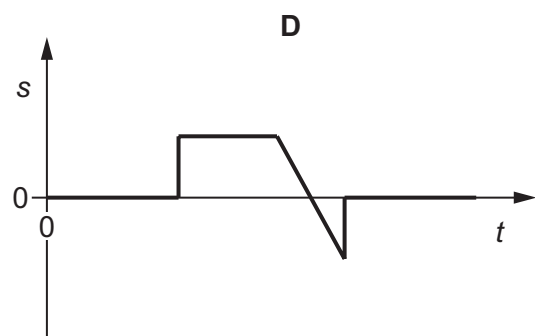
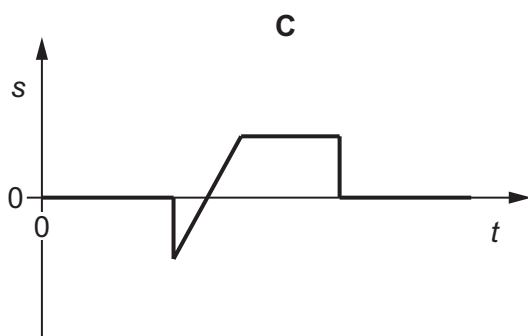
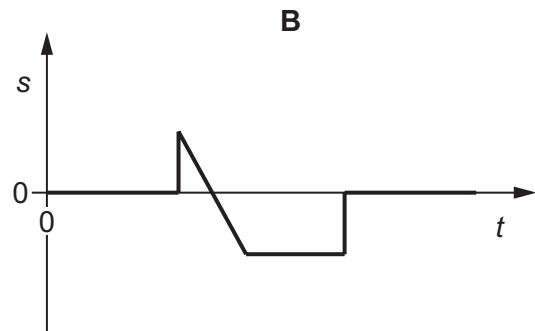
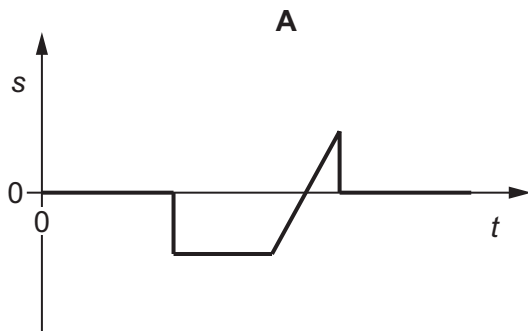

- 22 A wave has period T , wavelength λ and amplitude A . The wave is shown on a graph of displacement x against distance d .

Which graph is correctly labelled?

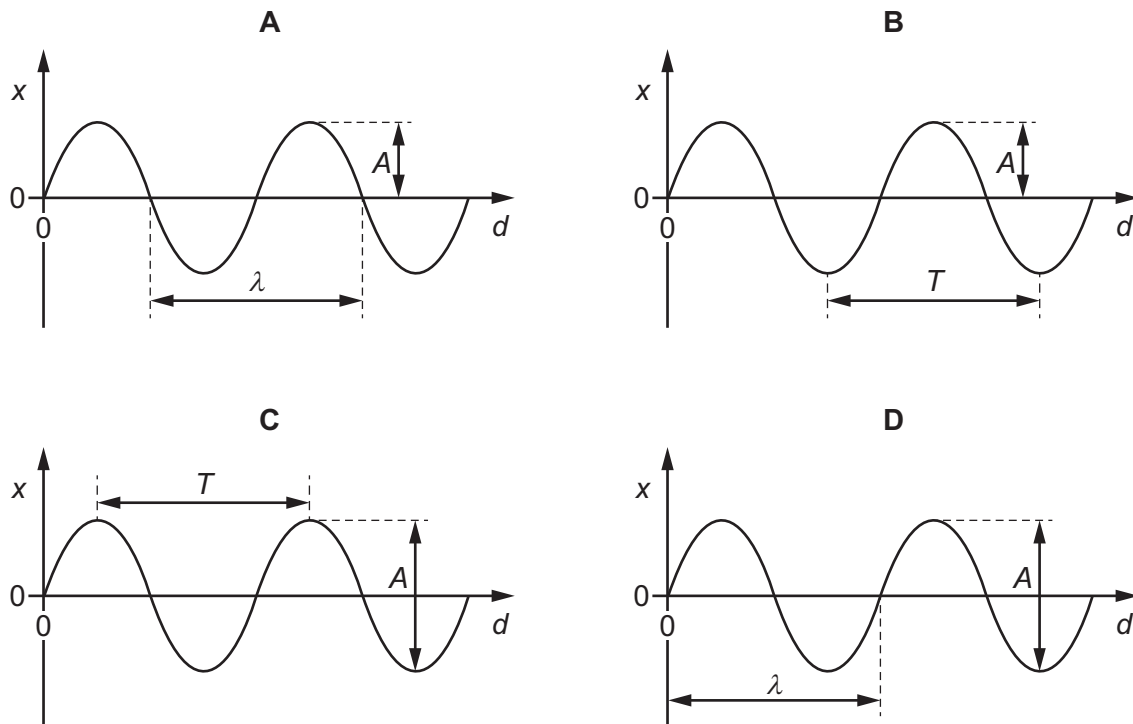

- 23 The table lists possible orders of magnitude of the wavelengths of some of the principal radiations of the electromagnetic spectrum.

Which row shows the correct orders of magnitude of the wavelengths?

	wavelength / m			
	microwaves	infra-red	ultraviolet	X-rays
A	10^{-6}	10^{-10}	10^{-12}	10^{-14}
B	10^{-4}	10^{-8}	10^{-10}	10^{-12}
C	10^{-2}	10^{-6}	10^{-8}	10^{-10}
D	10^2	10^{-4}	10^{-6}	10^{-8}

- 24** A vehicle carries a microwave transmitter that emits microwaves of a constant frequency. A stationary observer has a microwave receiver.

The vehicle moves directly towards the observer at constant speed. The observer detects microwaves of frequency F_0 .

The vehicle then accelerates, still moving towards the observer, travels at higher steady speed for a time and then decelerates until it stops.

What is the variation in the frequency of the microwaves that are detected by the observer?

- A** The observed frequency will fall, then remain steady then return to the frequency F_0 .
B The observed frequency will fall, then remain steady then rise to a higher frequency than F_0 .
C The observed frequency will rise, then remain steady then fall to a lower frequency than F_0 .
D The observed frequency will rise, then remain steady then return to the frequency F_0 .
- 25** The diagram shows a cathode-ray oscilloscope display of an electromagnetic wave.

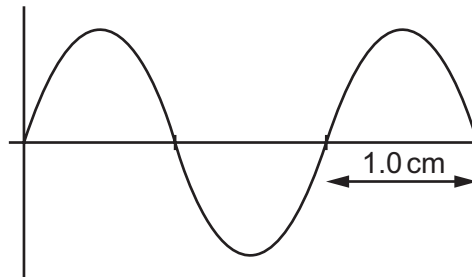

The time base setting is $0.20 \mu\text{s cm}^{-1}$.

Which statement is correct?

- A** The frequency of the wave is 2.5 MHz and it lies in the microwave region of the electromagnetic spectrum.
B The frequency of the wave is 2.5 MHz and it lies in the radio-wave region of the electromagnetic spectrum.
C The frequency of the wave is 5.0 MHz and it lies in the microwave region of the electromagnetic spectrum.
D The frequency of the wave is 5.0 MHz and it lies in the radio-wave region of the electromagnetic spectrum.
- 26** In a double-slit interference experiment, light of frequency 6.0×10^{14} Hz is incident on a pair of slits. Bright fringes that are 3.0 mm apart are observed on a screen some distance away.

What is the separation of the bright fringes when the frequency of the light is changed to 5.0×10^{14} Hz?

- A** 1.8 mm **B** 2.5 mm **C** 3.0 mm **D** 3.6 mm

- 27 Monochromatic light is incident on a pair of narrow slits a distance of 0.1 mm apart. A series of bright and dark fringes are observed on a screen a distance of 2.0 m away. The distance between adjacent bright fringes is 8.0 mm.

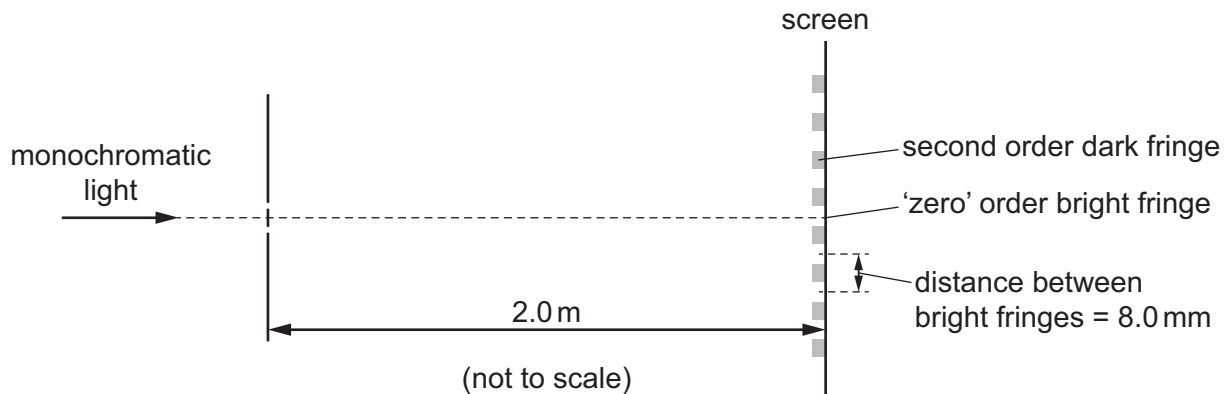

What is the path difference between the light waves from the two slits that meet at the second order dark fringe?

- A 2.0×10^{-7} m
 B 4.0×10^{-7} m
 C 6.0×10^{-7} m
 D 8.0×10^{-7} m
- 28 A tube of length L is open at both ends. A stationary wave is set up in this tube when a tuning fork vibrating with frequency f_x is held at one end. This is the lowest frequency of stationary wave that can be formed in this tube.

Another tube of length $2L$ is closed at one end. A stationary wave is set up in this tube when a tuning fork vibrating with frequency f_y is held at the open end. This is the lowest frequency of stationary wave that can be formed in this tube.

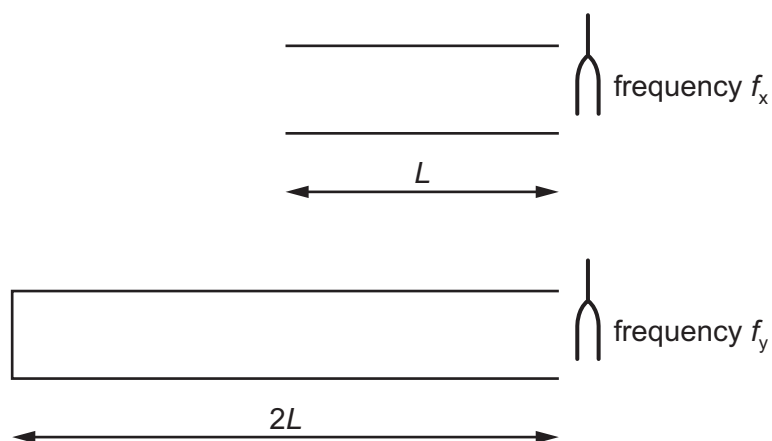

Assume the end correction for each tube is negligible.

Which equation is correct?

- A $f_x = \frac{f_y}{4}$ B $f_x = \frac{f_y}{2}$ C $f_x = 2f_y$ D $f_x = 4f_y$

- 29 Which statement gives a condition that enables diffraction to occur?
- A A source of waves moves towards a stationary observer.
 - B A wave is partially blocked by an obstacle.
 - C Two coherent waves are superposed.
 - D Two waves of equal speed and frequency are travelling through the same part of a medium in opposite directions.
- 30 An electron passes into the space between two parallel plates that are 5.0 cm apart and which are maintained at electric potentials of +2000 V and –500 V, respectively.

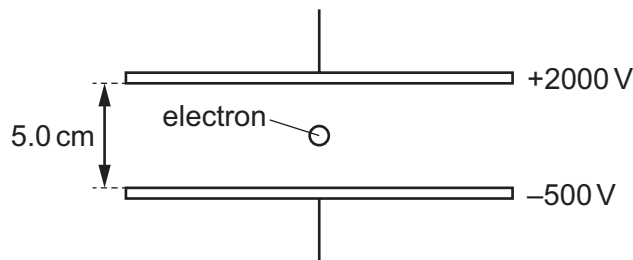

What is the electric force on the electron?

- A $1.6 \times 10^{-15} \text{ N}$
 - B $4.8 \times 10^{-15} \text{ N}$
 - C $6.4 \times 10^{-15} \text{ N}$
 - D $8.0 \times 10^{-15} \text{ N}$
- 31 Which statement about electric charges in a uniform electric field is **not** correct?
- A Electric charges of the same magnitude, whether positive or negative, experience the same magnitude of force when placed in the same uniform electric field.
 - B The direction of the force on a positive charge placed in a uniform electric field is independent of the magnitude of the charge.
 - C The magnitude of the force on a positive charge placed in a uniform electric field is proportional to the magnitude of the electric field strength.
 - D The work done to move a positive charge a certain distance in a uniform electric field is independent of the direction of the movement.

32 The diagram shows a simple circuit.

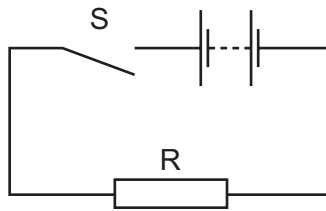

Which statement is correct?

- A When switch S is closed, the e.m.f. of the battery falls because work is done against the internal resistance of the battery.
 - B When switch S is closed, the e.m.f. of the battery falls because work is done against the resistance of R.
 - C When switch S is closed, the potential difference across the battery falls because work is done against the internal resistance of the battery.
 - D When switch S is closed, the potential difference across the battery falls because work is done against the resistance of R.
- 33 A resistor has resistance R . When the potential difference across the resistor is V , the current in the resistor is I . The power dissipated in the resistor is P . Work W is done when charge Q flows through the resistor.

What is **not** a valid relationship between these variables?

- A $I = \frac{P}{V}$
- B $Q = \frac{W}{V}$
- C $R = \frac{P}{I^2}$
- D $R = \frac{V}{P}$

34 A wire of resistance $9.55\ \Omega$ has a diameter of $0.280\ \text{mm}$.

It is made of metal of resistivity $4.90 \times 10^{-7}\ \Omega\ \text{m}$.

What is the length of the wire?

- A 1.20 m
 - B 4.80 m
 - C 19.0 m
 - D 76.8 m
- 35 Charge carriers, each of charge q , move along a wire of fixed length. The number density of the charge carriers in the wire is n .

What is also required, for this wire, to determine the average drift velocity of the charge carriers in terms of n and q ?

- A current per unit of cross-sectional area
- B potential difference per unit of length
- C resistance and cross-sectional area
- D resistivity and length

- 36 A potential divider circuit is constructed with one variable resistor X and one fixed resistor Y, as shown.

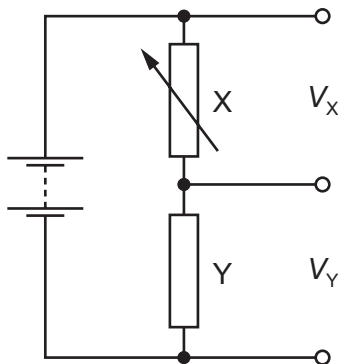

The potential difference across resistor X is V_X and the potential difference of resistor Y is V_Y .

As the resistance of X is increased, what happens to V_X and to V_Y ?

	V_X	V_Y
A	falls	rises
B	falls	stays the same
C	rises	falls
D	rises	stays the same

- 37 A cell of electromotive force (e.m.f.) E and negligible internal resistance is connected into a circuit, as shown.

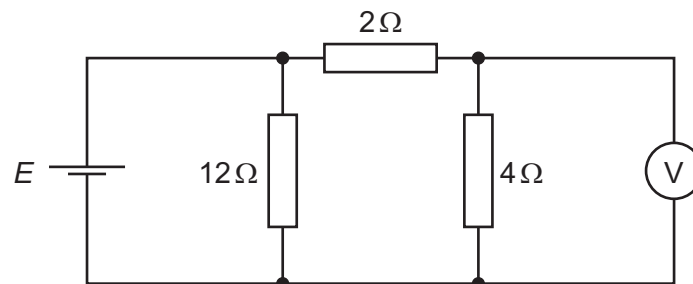

The voltmeter has a very high resistance and reads a potential difference V_{out} .

What is the ratio $\frac{V_{\text{out}}}{E}$?

- A** $\frac{1}{6}$ **B** $\frac{1}{3}$ **C** $\frac{1}{2}$ **D** $\frac{2}{3}$

38 Five resistors are connected as shown.

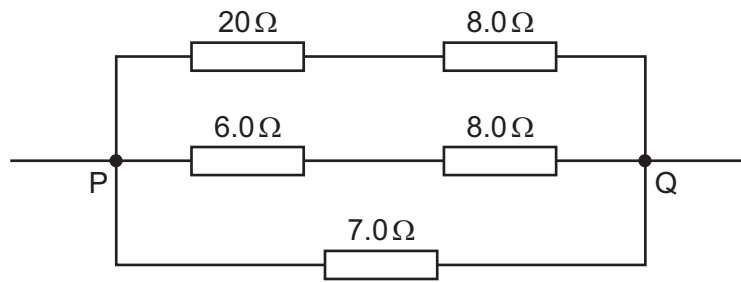

What is the total resistance between points P and Q?

- A** $0.25\ \Omega$ **B** $0.61\ \Omega$ **C** $4.0\ \Omega$ **D** $16\ \Omega$

39 A nucleus of neptunium-236 contains 93 protons and 143 neutrons. This nucleus decays with the emission of an α -particle. The nucleus formed then emits a β^- particle.

Which diagram shows the changes in the number P of protons and the number N of neutrons in these nuclei?

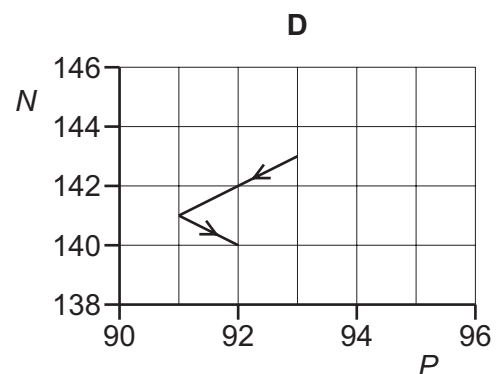
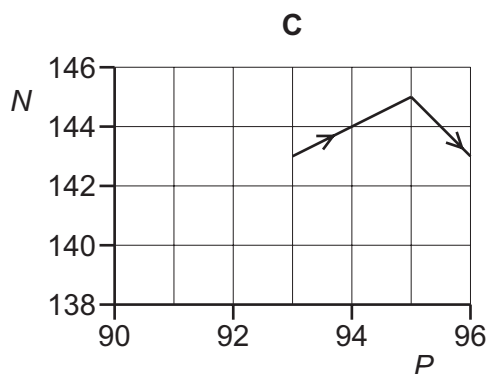
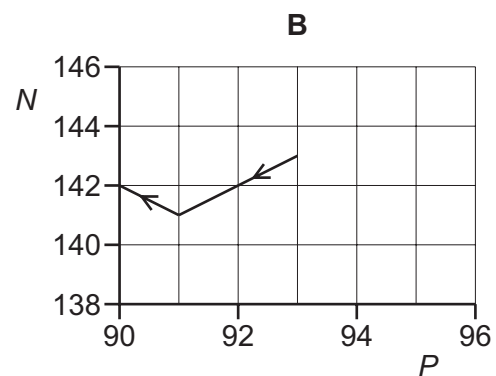
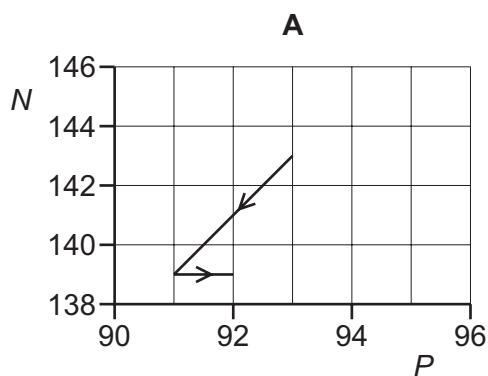

40 An isolated neutron decays to produce a proton, a β^- particle and an antineutrino.

Which row gives the quark composition of the neutron and the proton and the type of force that gives rise to this reaction?

	quark composition		type of force
	neutron	proton	
A	down, down, up	down, up, up	strong interaction
B	down, down, up	down, up, up	weak interaction
C	down, up, up	down, down, up	strong interaction
D	down, up, up	down, down, up	weak interaction

BLANK PAGE

Permission to reproduce items where third-party owned material protected by copyright is included has been sought and cleared where possible. Every reasonable effort has been made by the publisher (UCLES) to trace copyright holders, but if any items requiring clearance have unwittingly been included, the publisher will be pleased to make amends at the earliest possible opportunity.

To avoid the issue of disclosure of answer-related information to candidates, all copyright acknowledgements are reproduced online in the Cambridge International Examinations Copyright Acknowledgements Booklet. This is produced for each series of examinations and is freely available to download at www.cie.org.uk after the live examination series.

Cambridge International Examinations is part of the Cambridge Assessment Group. Cambridge Assessment is the brand name of University of Cambridge Local Examinations Syndicate (UCLES), which is itself a department of the University of Cambridge.