



Cambridge O Level

BIOLOGY**5090/11**

Paper 1 Multiple Choice

October/November 2020**1 hour**

You must answer on the multiple choice answer sheet.

You will need: Multiple choice answer sheet
Soft clean eraser
Soft pencil (type B or HB is recommended)

INSTRUCTIONS

- There are **forty** questions on this paper. Answer **all** questions.
- For each question there are four possible answers **A, B, C** and **D**. Choose the **one** you consider correct and record your choice in soft pencil on the multiple choice answer sheet.
- Follow the instructions on the multiple choice answer sheet.
- Write in soft pencil.
- Write your name, centre number and candidate number on the multiple choice answer sheet in the spaces provided unless this has been done for you.
- Do **not** use correction fluid.
- Do **not** write on any bar codes.
- You may use a calculator.

INFORMATION

- The total mark for this paper is 40.
- Each correct answer will score one mark. A mark will not be deducted for a wrong answer.
- Any rough working should be done on this question paper.

This document has **20** pages. Blank pages are indicated.

2

1 The diagram shows the structure of a cell from a leaf of a green plant.

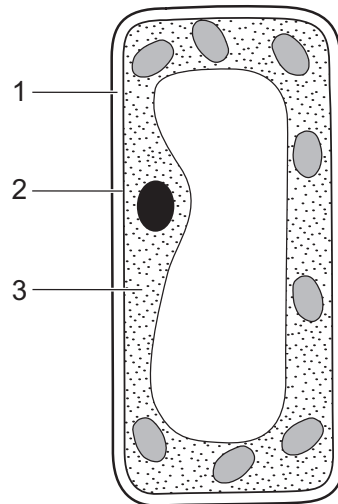

What are the numbered parts of the cell?

	1	2	3
A	cell membrane	cell wall	cytoplasm
B	cell membrane	cytoplasm	cell wall
C	cell wall	cytoplasm	cell membrane
D	cell wall	cell membrane	cytoplasm

- 2 The diagram shows three plant cells labelled P, Q and R. The arrows show the direction of water movement by osmosis.

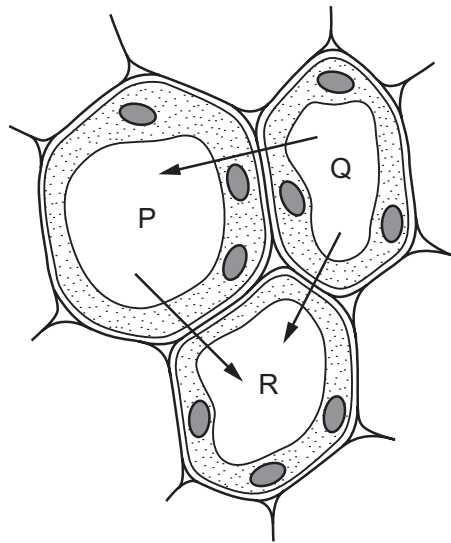

What is the correct order of water potential in the cells, from the highest to the lowest?

	highest	middle	lowest
A	P	Q	R
B	P	R	Q
C	Q	P	R
D	R	P	Q

4

- 3 An experiment measured the rate at which plants take up magnesium ions from solution. One plant was given a poison that stops respiration. Another plant was left as normal. The graph shows the results.

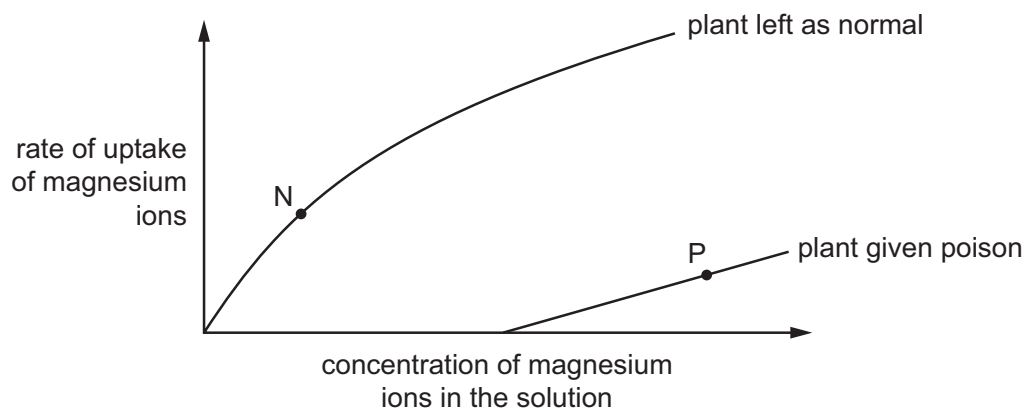

How are the magnesium ions being absorbed by the plants at points N and P?

	point N	point P
A	active transport	active transport
B	active transport	diffusion
C	diffusion	active transport
D	diffusion	diffusion

- 4 Starch digestion occurs in the mouth cavity and in the duodenum but it stops in the stomach.

Why is this?

- A** All the starch has been digested before it reaches the stomach.
- B** Cells in the stomach do not produce amylase.
- C** The pH in the stomach changes the shape of the amylase.
- D** The temperature in the stomach is too high for amylase to work.

- 5 Which row correctly shows the number of molecules, for each substance used and produced, during photosynthesis?

	substances used	number of molecules	substances produced	number of molecules
A	CO ₂ H ₂ O	1 1	C ₆ H ₁₂ O ₆ O ₂	1 1
B	CO ₂ H ₂ O	1 6	C ₆ H ₁₂ O ₆ O ₂	6 1
C	CO ₂ H ₂ O	1 6	C ₆ H ₁₂ O ₆ O ₂	6 6
D	CO ₂ H ₂ O	6 6	C ₆ H ₁₂ O ₆ O ₂	1 6

- 6 How do carbon dioxide and water enter a leaf?

	carbon dioxide	water
A	diffusion	active transport
B	diffusion	transpiration pull
C	osmosis	active transport
D	osmosis	transpiration pull

- 7 The graph shows how the rate of photosynthesis varies with light intensity at two different temperatures. Other variables are kept the same.

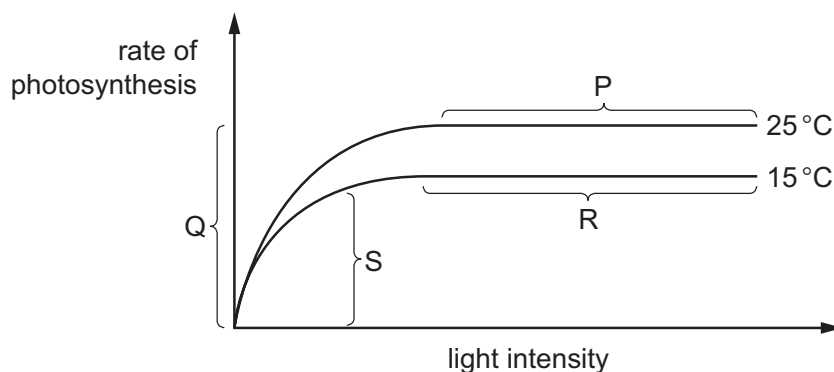

In which sections of the graph is light intensity limiting the rate of photosynthesis?

- A** P and R **B** Q and S **C** R and Q **D** S and P

- 8 The diagram shows the human alimentary canal.

In which part does protein digestion begin?

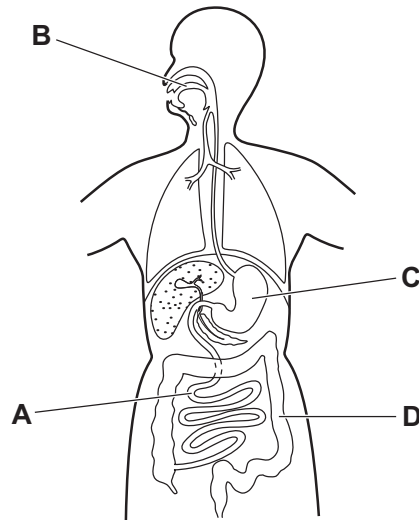

- 9 Blood flows away from the small intestine in the hepatic portal vein.

Where does the blood go next, and what may happen there?

- A the kidneys, delivering glucose for respiration
 - B the kidneys, for removal of urea
 - C the liver, where alcohol is broken down
 - D the liver, where bile is added to the blood
- 10 The symptoms of a disease include weakness, fatigue, aching and swollen joints, and swollen and soft gums.

Which food is used to treat this disease?

- A liver as a source of iron
- B milk as a source of calcium
- C oily fish as a source of vitamin D
- D oranges as a source of vitamin C

11 Which diagram shows the position of phloem tissue in a herbaceous, dicotyledonous root?

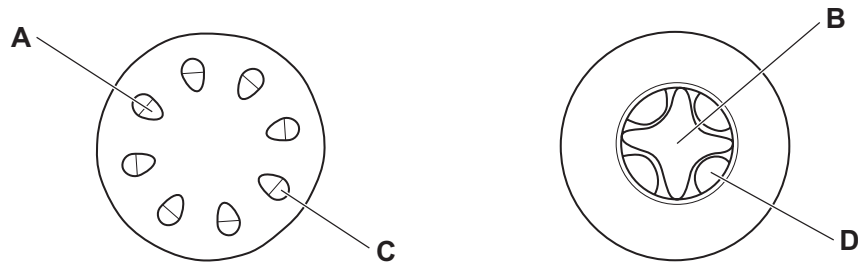

12 The diagram represents part of a leaf.

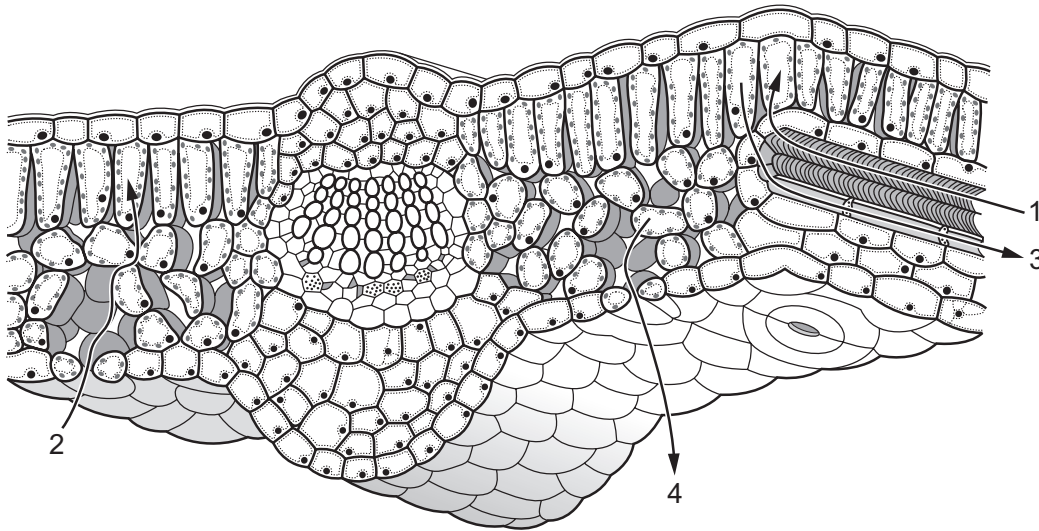

Which arrows show translocation and transpiration?

	translocation	transpiration
A	1	2
B	2	3
C	3	4
D	4	1

- 13 In the process of blood clotting, the1..... help to convert2..... to3..... which forms a clot.

Which words complete the description of blood clotting?

	1	2	3
A	platelets	fibrin	fibrinogen
B	platelets	fibrinogen	fibrin
C	red blood cells	fibrin	fibrinogen
D	red blood cells	fibrinogen	fibrin

- 14 The diagram shows a section of capillary.

Which arrow represents tissue fluid formation?

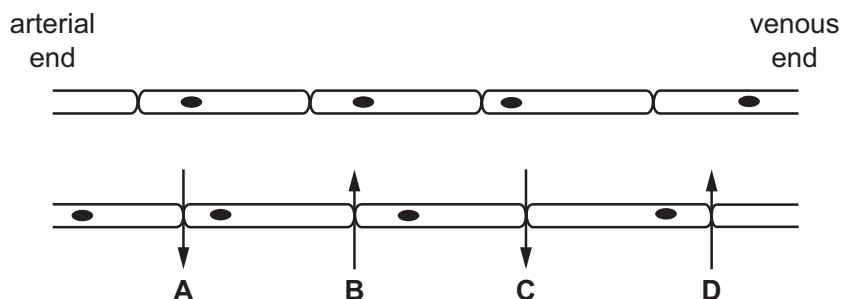

- 15 Which row shows possible causes of coronary heart disease?

	diet high in saturated fats	diet low in salt	regular exercise
A	✓	✓	x
B	✓	x	x
C	x	✓	✓
D	x	x	✓

key

✓ = yes

x = no

- 16 What are the products of anaerobic respiration in yeast?

- A** alcohol, carbon dioxide and a high energy yield
- B** alcohol, carbon dioxide and a low energy yield
- C** carbon dioxide, water and a high energy yield
- D** carbon dioxide, water and a low energy yield

17 The diagram shows apparatus used to investigate respiration.

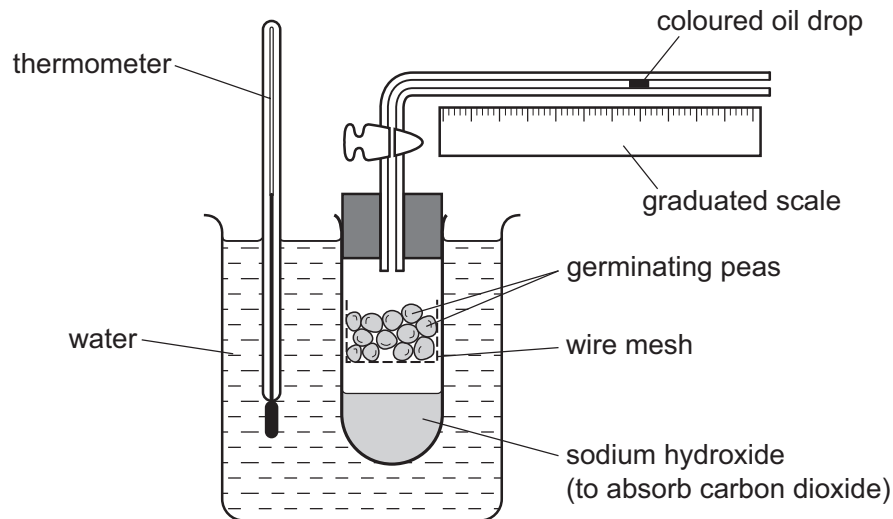

Which change will be seen and what is the explanation?

	change	explanation
A	oil drop moves left	oxygen is used up by the peas
B	oil drop does not move	oxygen is used up as fast as carbon dioxide is released
C	oil drop does not move	carbon dioxide is absorbed
D	oil drop moves right	peas release carbon dioxide

- 18 The diagram shows the rib cage and some of the muscles involved in breathing as seen from the side.

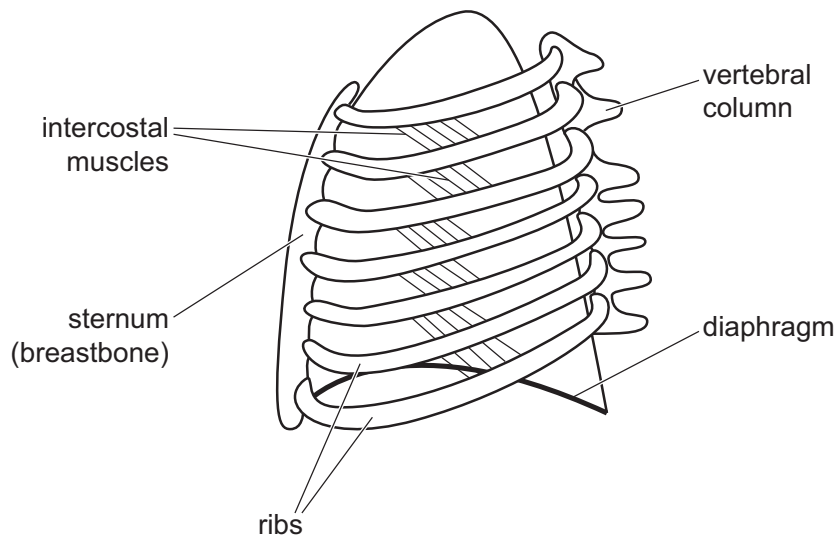

What happens when the intercostal muscles shown in the diagram contract?

- A The diaphragm moves down.
 - B The lungs inflate.
 - C The pressure inside the lungs decreases.
 - D The ribs move down.
- 19 During dialysis, substances such as glucose, mineral salts, urea and water move between the patient's blood and the dialysis fluid.

Which processes are involved in these movements?

	active transport	diffusion
A	yes	yes
B	no	yes
C	yes	no
D	no	no

20 Which organs in humans are involved in maintaining body temperature?

	brain	skin	
A	✓	✓	key ✓ = yes x = no
B	✓	x	
C	x	✓	
D	x	x	

21 The diagram shows a section through the brain.

Which part is the hypothalamus?

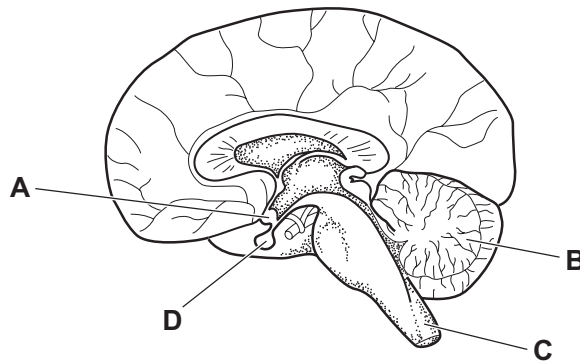

22 The diagram shows a section through the eye.

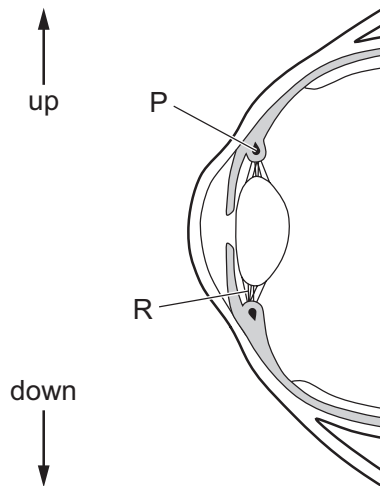

When the person looks down and focuses on their mobile phone, what is the state of the structures P and R?

	P	R
A	contracted	loose
B	contracted	tight
C	relaxed	loose
D	relaxed	tight

23 What is a sign of diabetes mellitus?

- A** glucose in the blood
- B** glucose in the urine
- C** insulin in the blood
- D** insulin in the urine

24 The diagram shows the bones of the human arm.

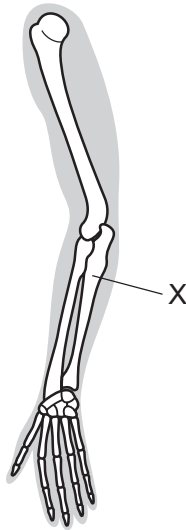

Which is the bone labelled X?

- A humerus
- B radius
- C scapula
- D ulna

25 For which diseases can antibiotics be used as effective treatments?

- A bacterial infections
- B coronary heart disease
- C malaria
- D viral infections

26 The table shows the characteristics of four microorganisms.

Which one could be a virus?

	contains one or more cells	contains one or more cell nuclei	produces spores
A	x	x	x
B	✓	x	x
C	✓	✓	x
D	✓	✓	✓

key

✓ = true

x = false

- 27** Which statement comparing the production of single cell protein and the production of protein in meat is **not** correct?
- A** Single cell protein can be produced more quickly.
 - B** Production of single cell protein is independent of climatic changes.
 - C** Production of single cell protein requires more space.
 - D** Single cell protein contains less fat and more dietary fibre.
- 28** Which statement describes relationships in ecosystems?
- A** Carbohydrates are passed from decomposers to producers.
 - B** Energy is passed from carnivores to herbivores.
 - C** Proteins are passed from primary consumers to producers.
 - D** Carbohydrates are passed from producers to herbivores.
- 29** Mealybugs are small insects that can feed on crops such as mango and coffee. They damage the crops and reduce the yield and profits for farmers. Lacewing insects and ladybird beetles both eat mealybugs.

Which row shows the positions of some of the organisms in this food chain?

	producer	herbivore	carnivore
A	lacewing	mealybug	coffee
B	coffee	mealybug	lacewing
C	mealybug	ladybird	mango
D	mango	ladybird	mealybug

30 The diagram shows the carbon cycle.

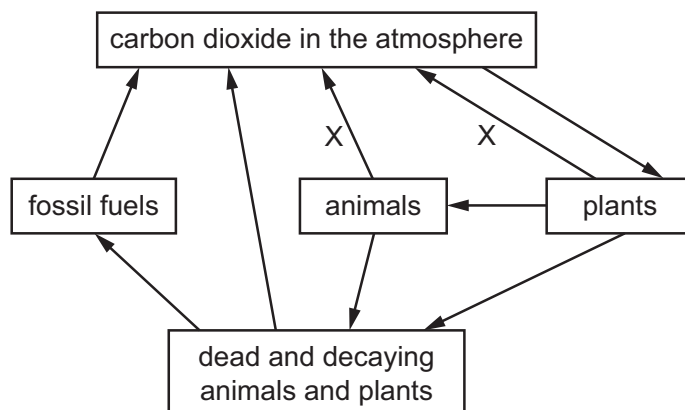

What is process X?

- A burning
- B decomposition
- C photosynthesis
- D respiration

31 Three statements about malarial parasites are listed.

- 1 Insecticides are used to kill the vectors.
- 2 Netting is used to keep the vectors away from people.
- 3 People take drugs that stop the malarial pathogen developing.

Which methods can be used to control malaria?

- A 1, 2 and 3
- B 1 and 2 only
- C 1 only
- D 2 and 3 only

32 What would be an **undesirable** feature in an insecticide?

- A It becomes more concentrated at each stage in the food web.
- B It breaks down within a few months.
- C It destroys one particular insect only.
- D It destroys the immature forms of an insect.

33 The diagram shows a section of a flower.

Where are the male gametes made?

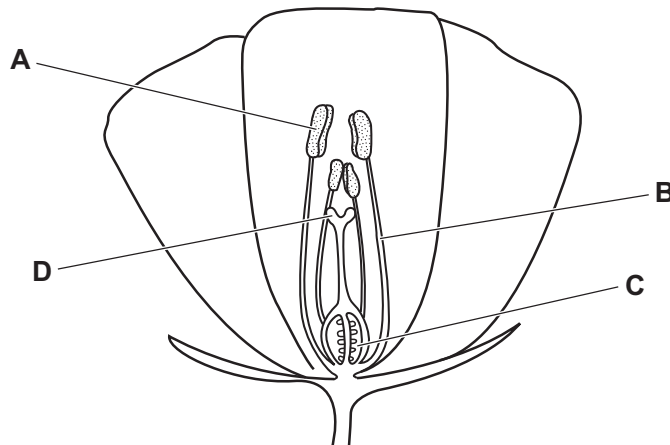

34 What is **not** an essential condition for the germination of seeds?

- A presence of carbon dioxide
- B presence of oxygen
- C presence of water
- D suitable temperature

35 What is an advantage to a baby of breast-feeding compared with bottle feeding?

- A Only breast milk contains all the vitamins a growing baby needs.
- B Only breast milk contains antibodies.
- C Only breast milk is sterile.
- D Only breast milk provides the correct volume of milk for the baby.

36 The diagram shows a calendar for 33 days in February and March.

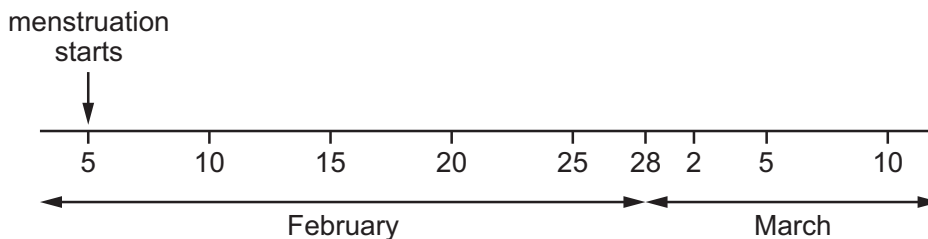

A girl, who has a regular menstrual cycle of 28 days, begins menstruation on 5 February.

During which dates would the progesterone concentration in her blood rise most rapidly?

- A 5–12 February
 - B 13–19 February
 - C 20–26 February
 - D 27 February – 5 March
- 37 In a species of mouse, fur colour can be black or white. Two black female mice were allowed to mate with the same black male. One female had nine young, all of which were black. The other female had seven young, five black and two white.

One of these white mice was male, and is allowed to mate with a heterozygous female.

What is the expected ratio of phenotypes of their offspring?

- A 1 black : 1 white
- B 1 black : 3 white
- C 1 black : 2 grey : 1 white
- D 3 black : 1 white

38 The diagram shows the blood group phenotypes of some members of a family.

Which member of the F1 generation must be heterozygous with the codominant alleles?

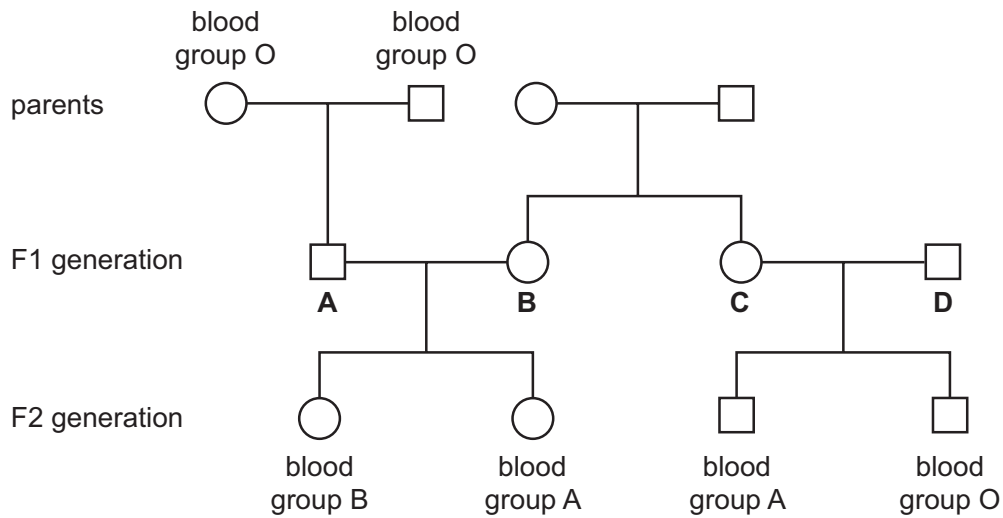

39 The diagram shows the distribution of a human characteristic, X, in the population.

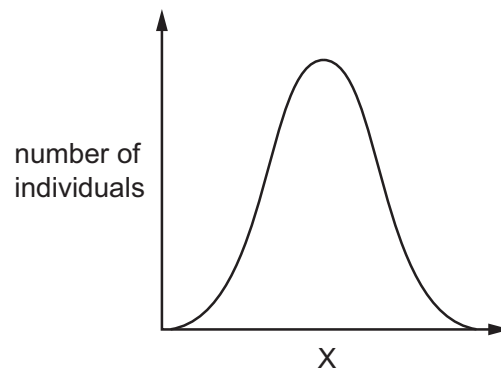

What is the characteristic X?

- A blood group
- B eye colour
- C height
- D sex

40 Which statements about the use of bacteria to produce human insulin are correct?

- 1 Enzymes are used to cut out the human insulin gene.
- 2 The human insulin gene is transferred to bacterial DNA.
- 3 The bacterial DNA is transferred into human cells.

	statement			
	1	2	3	
A	✓	✓	✓	key ✓ = correct ✗ = incorrect
B	✓	✓	✗	
C	✓	✗	✓	
D	✗	✓	✓	

BLANK PAGE

Permission to reproduce items where third-party owned material protected by copyright is included has been sought and cleared where possible. Every reasonable effort has been made by the publisher (UCLES) to trace copyright holders, but if any items requiring clearance have unwittingly been included, the publisher will be pleased to make amends at the earliest possible opportunity.

To avoid the issue of disclosure of answer-related information to candidates, all copyright acknowledgements are reproduced online in the Cambridge Assessment International Education Copyright Acknowledgements Booklet. This is produced for each series of examinations and is freely available to download at www.cambridgeinternational.org after the live examination series.

Cambridge Assessment International Education is part of the Cambridge Assessment Group. Cambridge Assessment is the brand name of the University of Cambridge Local Examinations Syndicate (UCLES), which itself is a department of the University of Cambridge.