



UNIVERSITY OF CAMBRIDGE INTERNATIONAL EXAMINATIONS
General Certificate of Education Ordinary Level

CANDIDATE
NAME

CENTRE
NUMBER

--	--	--	--	--

CANDIDATE
NUMBER

--	--	--	--



MATHEMATICS (SYLLABUS D)

4024/11

Paper 1

May/June 2011

2 hours

Candidates answer on the Question Paper.

Additional Materials: Geometrical instruments

READ THESE INSTRUCTIONS FIRST

Write your Centre number, candidate number and name on all the work you hand in.

Write in dark blue or black pen.

You may use a pencil for any diagrams or graphs.

Do not use staples, paper clips, highlighters, glue or correction fluid.

DO NOT WRITE IN ANY BARCODES.

Answer **all** questions.

If working is needed for any question it must be shown in the space below that question.

Omission of essential working will result in loss of marks.

ELECTRONIC CALCULATORS MUST NOT BE USED IN THIS PAPER.

The number of marks is given in brackets [] at the end of each question or part question.

The total of the marks for this paper is 80.

This document consists of **20** printed pages.



ELECTRONIC CALCULATORS MUST NOT BE USED IN THIS PAPER.**1** Evaluate

(a) $52.3 \times 10 - 3.76 \times 100,$

Answer [1]

(b) $20 - 8 \div 2 + 1.$

Answer [1]**2 (a)** Express 18% as a fraction in its lowest terms.*Answer* [1]**(b)** Write down an irrational number between 3 and 4.*Answer* [1]

3 Evaluate

(a) $\frac{2}{3} + \frac{3}{10}$,

Answer [1]

(b) $1\frac{3}{5} \div 3$.

Answer [1]

4 Write down

(a) a square number that is a factor of 75,

Answer [1]

(b) a cube number that is a multiple of 24.

Answer [1]

- 5 An instrument is used to measure the height of an object above sea level. The height, in metres, is shown on the dial.

(a) What is the reading on the dial?

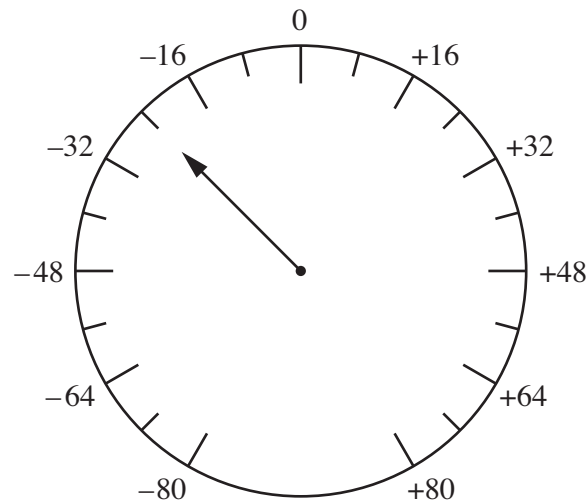

Answer m [1]

- (b) The object moves from position A, where the dial reads -54 , to position B, where the dial reads $+48$.

What is the difference in height between A and B?

Answer m [1]

6 Evaluate

(a) $8^{\frac{2}{3}}$,

Answer [1]

(b) $\left(\frac{1}{6}\right)^{-2}$.

Answer [1]

7 (a) Using set notation, describe the shaded region in the Venn diagram.

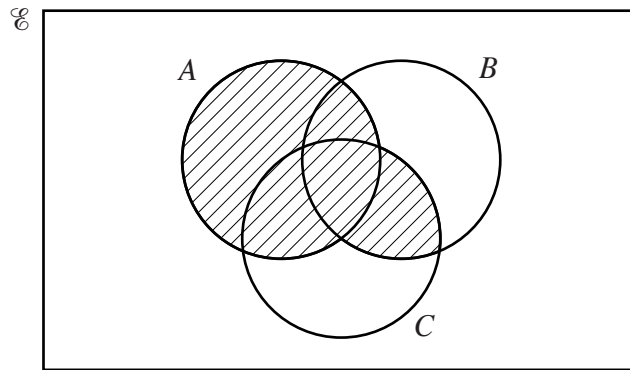

Answer [1]

(b) In the Venn diagram, shade the region represented by $P' \cap (Q \cup R)$.

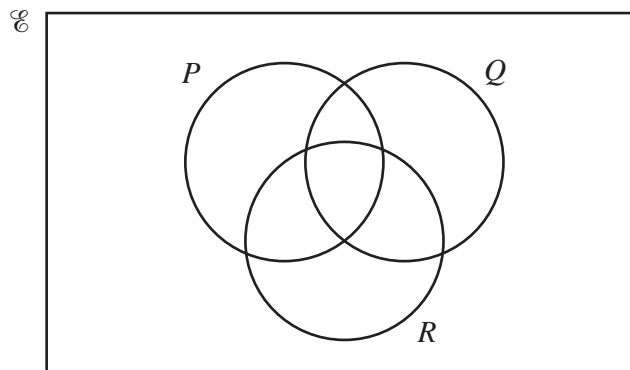

[1]

6

- 8 (a) A bag contains red and blue pens in the ratio 2 : 7.
There are 18 red pens in the bag.

How many blue pens are in the bag?

Answer [1]

- (b) A box contains apples and oranges.
The ratio of apples to oranges is 2 : 3.

What percentage of the fruit are oranges?

Answer% [1]

- 9 Factorise completely

(a) $12ab^2 - 8a^2b$,

Answer [1]

(b) $2x^2 + 3x - 20$.

Answer [2]

- 10 (a) Sara sets out on a journey at 10 50.
She travels 65 km at an average speed of 20 km/h.

At what time does she complete her journey?

Answer [2]

- (b) Kevin takes T minutes to travel to work.
Jane travels the same distance to work but goes 10% faster than Kevin.

Find an expression, in terms of T , for the number of minutes that Jane takes to travel to work.

Answer [1]

11 In the diagram below, the equation of the line AB is $2y = 9 - 3x$.

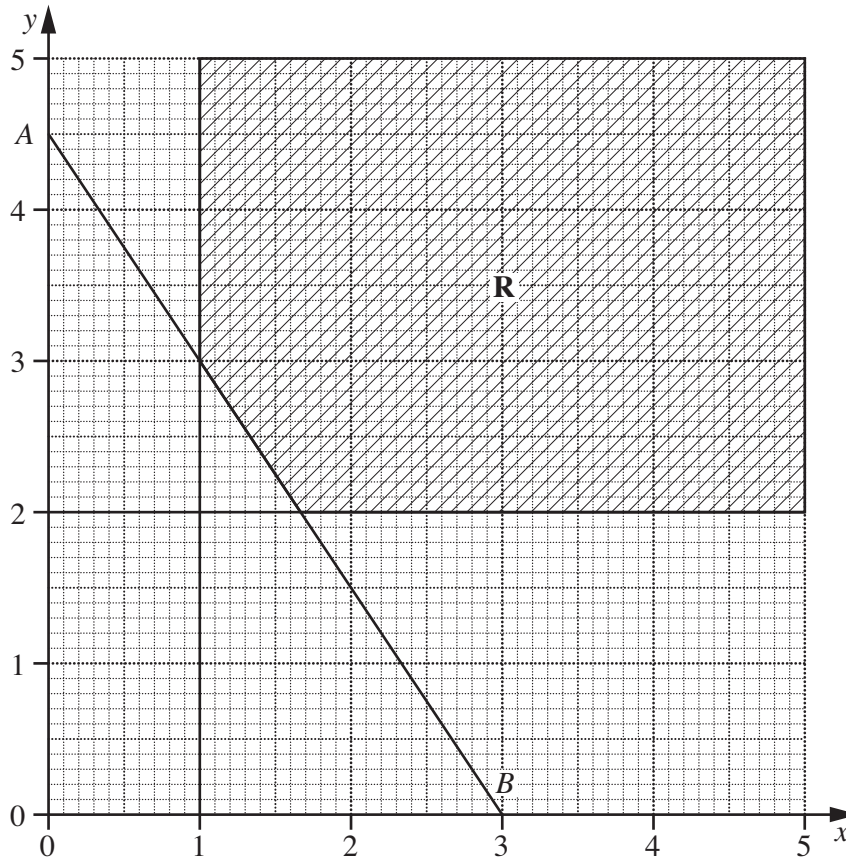

(a) What is the gradient of AB ?

Answer [1]

(b) The shaded region R is defined by five inequalities.
Two of these are $x \leq 5$ and $y \leq 5$.

Write down the other three inequalities.

Answer
.....
..... [2]

12 (a) Show that the interior angle of a regular decagon is 144° .

[1]

- (b) AB and BC are two sides of a regular decagon.
 AB and BD are two sides of a regular hexagon.

Work out the value of x .

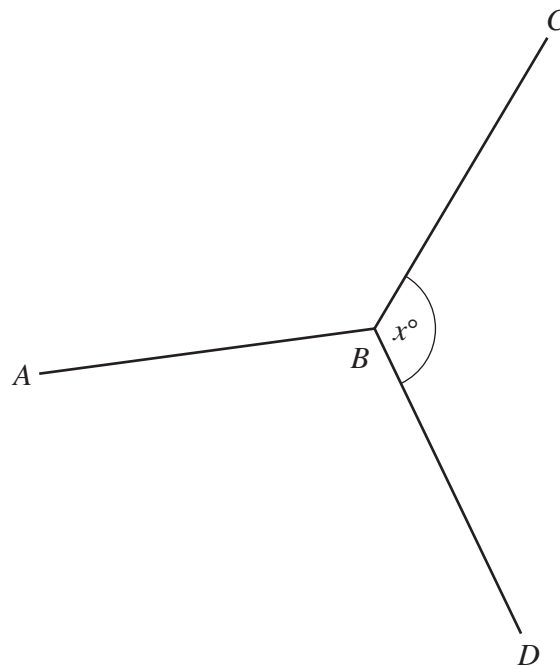

Answer $x = \dots\dots\dots$ [2]

- 13 Jamil recorded the number of text messages sent by the students in his class on one day. The results are shown in the bar chart.

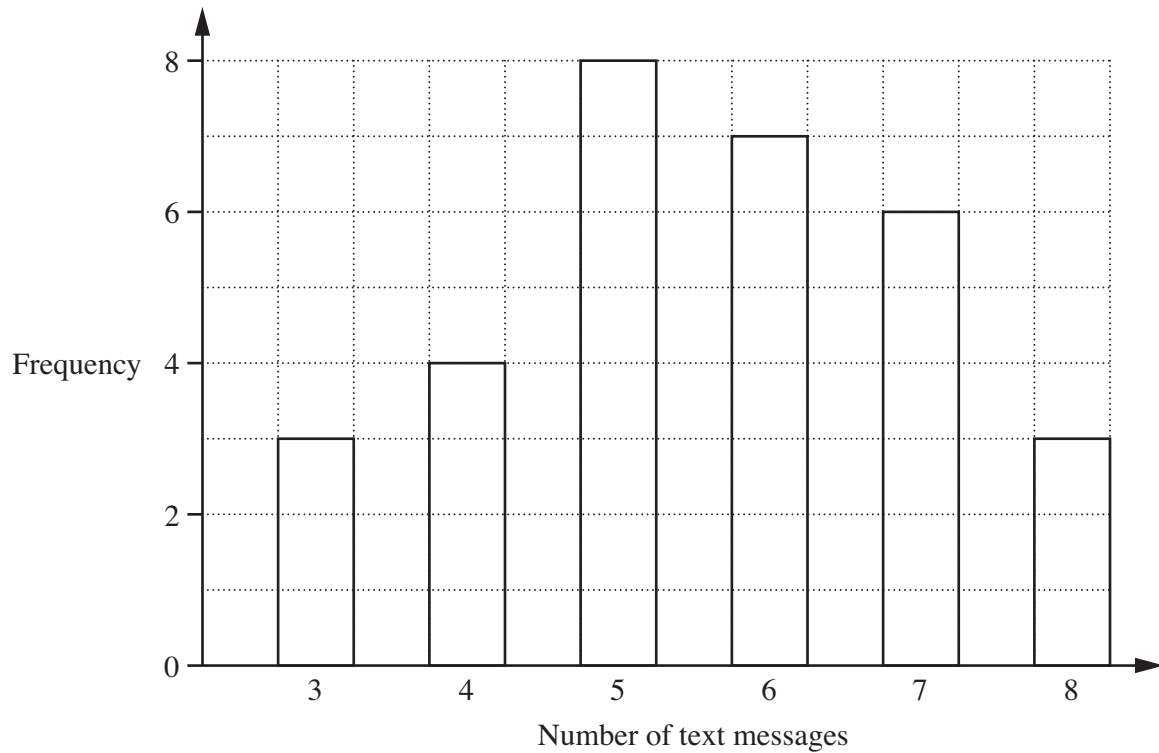

Use the bar chart to find

- (a) the number of students in Jamil's class,

Answer [1]

- (b) the median number of text messages sent,

Answer [1]

- (c) the modal number of text messages sent.

Answer [1]

- 14 (a) By writing each number correct to one significant figure, estimate the value of

$$\frac{7.84 \times 326}{0.18}$$

Answer [2]

- (b) An athlete ran a race in 9.58 seconds, correct to the nearest hundredth of a second.

What is the shortest possible time that the athlete could have run the race?

Answerseconds [1]

- 15 The two triangles below are similar.
The lengths are in centimetres.

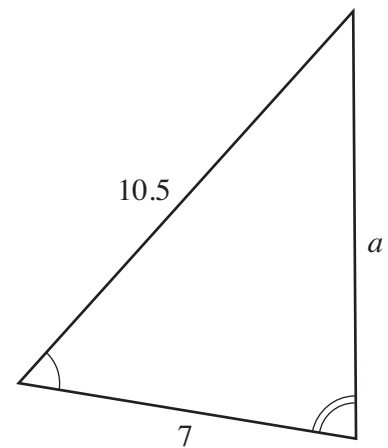
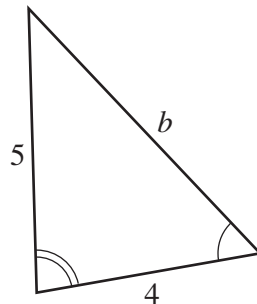

Calculate a and b .

Answer $a =$

$b =$ [3]

16 Solve

(a) $3x \geq 2 - 5x$,

Answer x [1]

(b) $\frac{5x}{x+1} - \frac{2}{x-1} = 8$.

Answer $x =$ or [3]

17

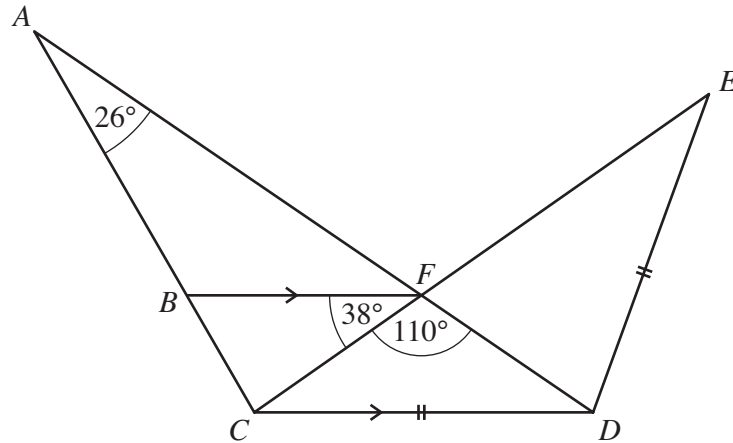

In the diagram, ACD and ECD are triangles with $CD = DE$.
 AD and EC intersect at F .
 B is the point on AC such that BF is parallel to CD .
 $\hat{B}AF = 26^\circ$, $\hat{B}FC = 38^\circ$ and $\hat{C}FD = 110^\circ$.

Find

(a) $\hat{F}CD$,

Answer $\hat{F}CD = \dots\dots\dots$ [1]

(b) $\hat{E}DC$,

Answer $\hat{E}DC = \dots\dots\dots$ [1]

(c) $\hat{A}BF$,

Answer $\hat{A}BF = \dots\dots\dots$ [1]

(d) $\hat{B}CF$.

Answer $\hat{B}CF = \dots\dots\dots$ [1]

18 The first four terms, u_1 , u_2 , u_3 and u_4 , in a sequence of numbers are given by

$$\begin{aligned}u_1 &= 1 \times 2 + 3^2 = 11 \\u_2 &= 2 \times 3 + 4^2 = 22 \\u_3 &= 3 \times 4 + 5^2 = 37 \\u_4 &= 4 \times 5 + 6^2 = 56.\end{aligned}$$

(a) Evaluate u_5 .

Answer [1]

(b) Write down an expression, in terms of n , for the n th term, u_n , of the sequence.

Answer [1]

(c) Given that $u_n = An^2 + Bn + C$, find the values of A , B and C .

Answer $A =$

$B =$

$C =$ [2]

- 19 (a) Vicky's fingernail grows one nanometre in one second.
One nanometre is 1×10^{-9} metres.
Vicky calculates how much her fingernail grows in one hour.

Find this length, in standard form, giving your answer

- (i) in metres,

Answer m [1]

- (ii) in millimetres.

Answer mm [1]

- (b) It is given that $2 \times 10^3(d + 3 \times 10^2) = 8 \times 10^6$.

Find d .

Answer $d =$ [2]

20 It is given that $h(x) = 2x - 5$ and $g(x) = \frac{3}{x-2}$.

Find

(a) $h(4)$,

Answer [1]

(b) $g^{-1}(x)$,

Answer [2]

(c) the value of t such that $h(t) = g(3)$.

Answer $t =$ [2]

- 21 Kelvin chooses a pair of trousers and a shirt to wear for college.
He chooses grey trousers or black trousers.
He chooses a red shirt or a yellow shirt.

The probability that he chooses grey trousers is $\frac{1}{3}$.

The probability that he chooses a red shirt is $\frac{4}{5}$.

His choice of shirt is independent of his choice of trousers.

- (a) Complete the tree diagram.

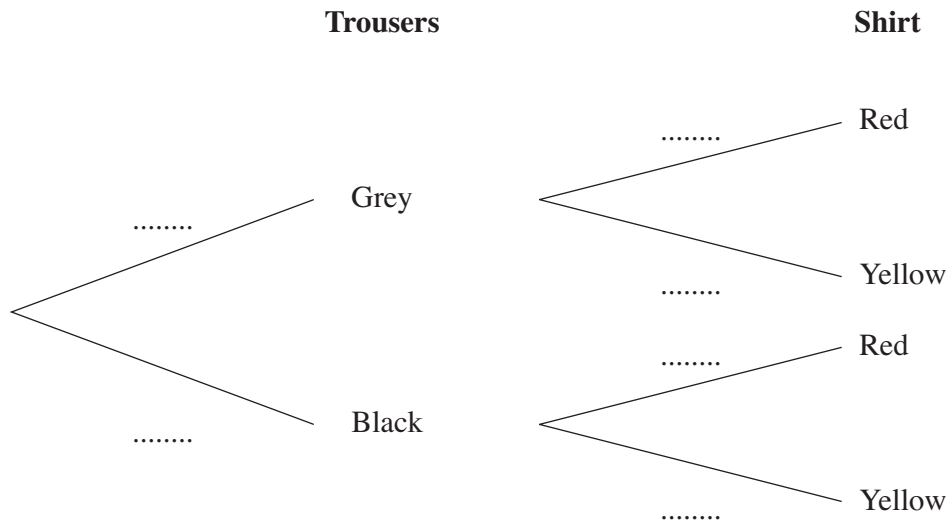

[2]

- (b) What is the probability that Kelvin chooses grey trousers and a red shirt?

Answer [1]

- (c) What is the probability that Kelvin does **not** choose either black trousers or a red shirt?

Answer [2]

- 22 The diagram shows a window made up of a large semicircle and a rectangle. The large semicircle has 4 identical sections, A, B, C, D, and a small semicircle, E. The rectangle has three identical square sections, F, G and H. The side of each square is 20 cm.

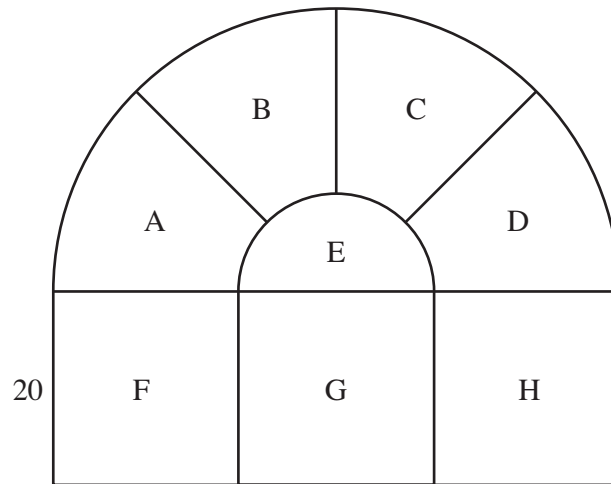

Find an expression, in the form $a + b\pi$, for

- (a) the area of the whole window,

Answercm² [2]

- (b) the perimeter of section B.

Answercm [3]

- 23 (a) Construct, using ruler and compasses only, triangle ABC with sides $AB = 9$ cm, $BC = 8$ cm and $AC = 6$ cm.
The line AB has been drawn for you.

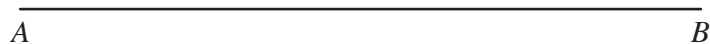

[2]

- (b) Construct the locus of points, inside the triangle ABC , which are

(i) equidistant from AB and BC , [1]

(ii) 4 cm from A . [1]

- (c) Shade the region, inside triangle ABC , containing the points that are nearer to BC than AB **and** more than 4 cm from A . [1]

Question 24 is printed on the following page.

24 The variables x and y are connected by the equation $y = x^3 - 6x$.

(a) Complete the table of values.

x	-2	-1	0	1	2	3
y		5	0		-4	9

[2]

(b) On the axes below, draw the graph of $y = x^3 - 6x$ for $-2 \leq x \leq 3$.

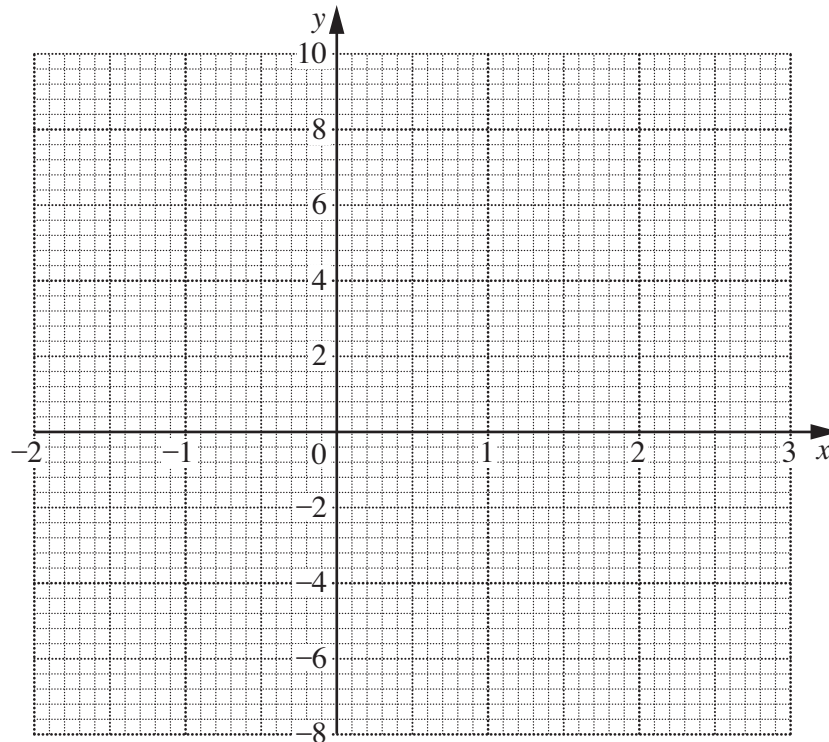

[2]

(c) Use your graph to find

(i) two solutions of the equation $x^3 - 6x = 0$,

Answer $x = \dots\dots\dots$ or $\dots\dots\dots$ [2]

(ii) the least value of y when x is positive.

Answer $y = \dots\dots\dots$ [1]

Permission to reproduce items where third-party owned material protected by copyright is included has been sought and cleared where possible. Every reasonable effort has been made by the publisher (UCLES) to trace copyright holders, but if any items requiring clearance have unwittingly been included, the publisher will be pleased to make amends at the earliest possible opportunity.

University of Cambridge International Examinations is part of the Cambridge Assessment Group. Cambridge Assessment is the brand name of University of Cambridge Local Examinations Syndicate (UCLES), which is itself a department of the University of Cambridge.