



UNIVERSITY OF CAMBRIDGE INTERNATIONAL EXAMINATIONS
International General Certificate of Secondary Education

CANDIDATE
NAME

CENTRE
NUMBER

--	--	--	--	--

CANDIDATE
NUMBER

--	--	--	--



* 9 4 4 5 9 2 0 2 5 4 *

CHEMISTRY

0620/62

Paper 6 Alternative to Practical

October/November 2010

1 hour

Candidates answer on the Question Paper.

No Additional Materials are required.

READ THESE INSTRUCTIONS FIRST

Write your Centre number, candidate number and name on all the work you hand in.

Write in dark blue or black pen.

You may use a pencil for any diagrams, graphs or rough working.

Do not use staples, paper clips, highlighters, glue or correction fluid.

DO NOT WRITE IN ANY BARCODES.

Answer **all** questions.

At the end of the examination, fasten all your work securely together.

The number of marks is given in brackets [] at the end of each question or part question.

For Examiner's Use

1	
2	
3	
4	
5	
6	
7	
Total	

This document consists of **13** printed pages and **3** blank pages.



- 1 The diagram shows the apparatus used by a student to find the concentration of hydrochloric acid. Sodium hydroxide solution was added to hydrochloric acid until the solution was neutral.

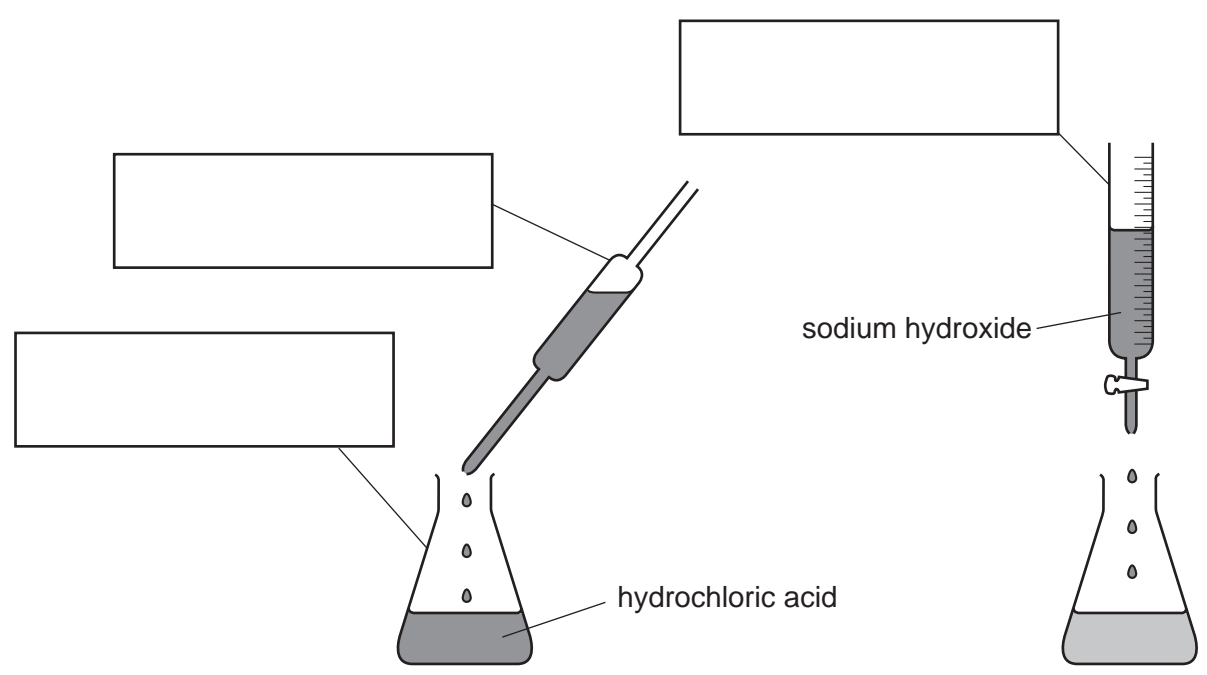

(a) Complete the boxes to name the apparatus used. [3]

(b) How could the student tell when the solution was neutral?
.....
..... [2]

[Total: 5]

3

2 Three bottles of liquids have lost their labels.
The liquids are known to be:

- aqueous potassium chloride,
- ethanol,
- sodium hydroxide solution.

Outline chemical tests you could use to distinguish between the liquids in the three bottles.

liquid	test	result
aqueous potassium chloride
ethanol
sodium hydroxide solution

[Total: 6]

- 3 Dilute sulfuric acid was added to zinc carbonate in a conical flask as shown.

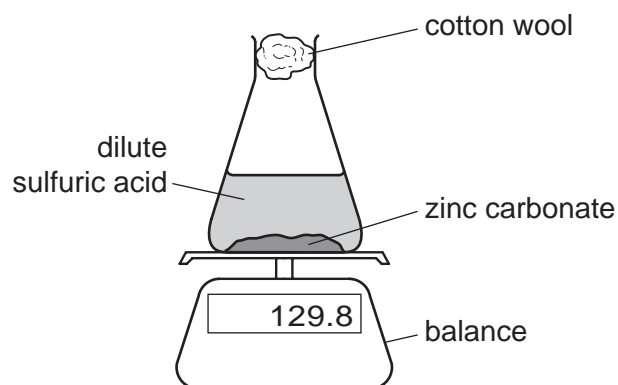

Two experiments were carried out.

Experiment 1

The flask was placed on a balance and the mass of the flask and contents recorded every five minutes. The temperature of the sulfuric acid was 30 °C.

The results have been plotted on the grid.

Experiment 2

Experiment 1 was repeated but the temperature of the acid was different. The results are shown in the table.

Table of results for Experiment 2

time / minutes	0	5	10	15	20	25	30
mass of flask and contents / g	129.8	128.4	127.0	125.6	124.0	122.6	121.2

(a) Plot the results for Experiment 2 on the grid and draw a straight line graph.

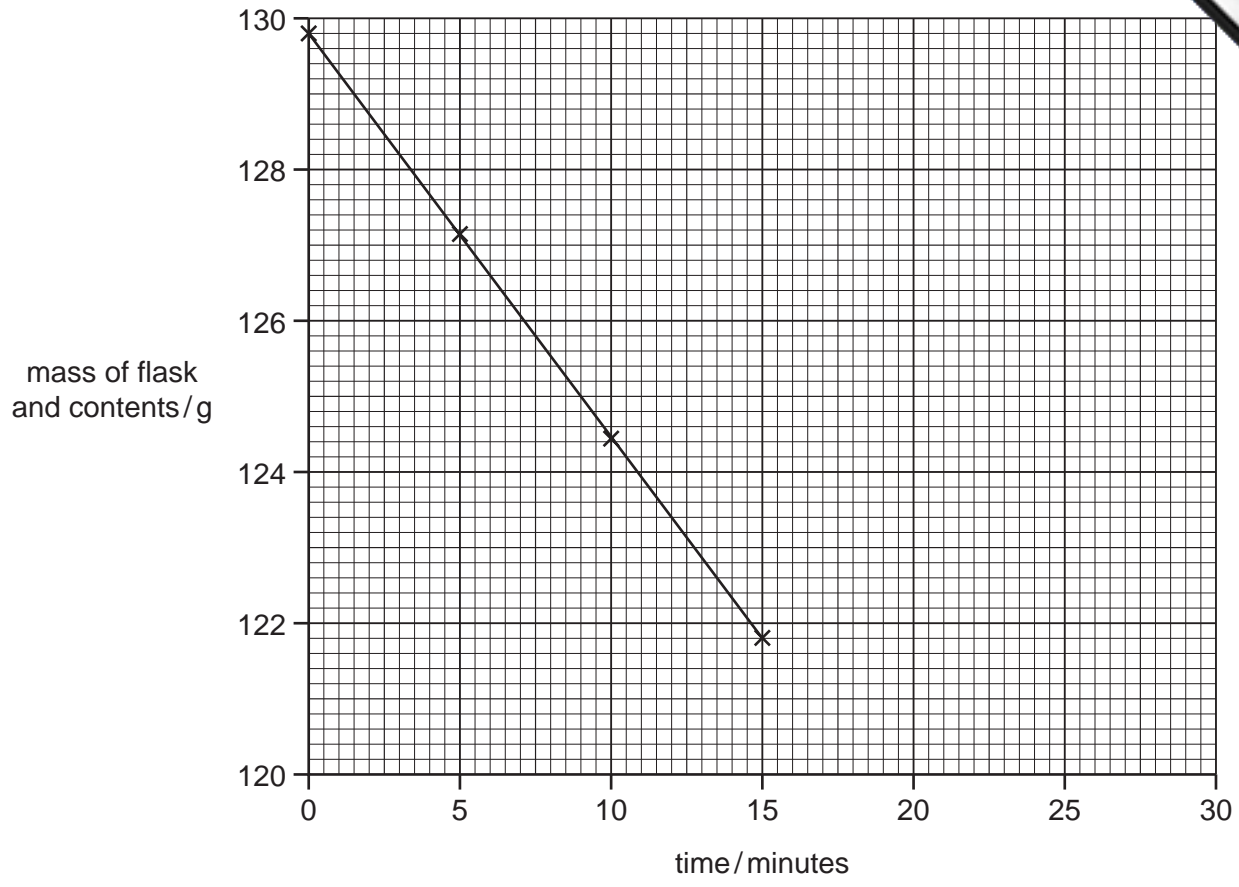

[3]

(b) Why does the mass of the flask and contents decrease?

..... [1]

(c) Suggest the purpose of the cotton wool.

..... [1]

(d) (i) In which experiment was the loss of mass of the flask and contents the fastest?

..... [1]

(ii) Compare the temperature of the sulfuric acid in Experiment 2 with Experiment 1.

..... [1]

(e) Use the graph for Experiment 1 to find the time taken for the mass of the flask and contents to decrease to 120g. Indicate clearly **on the grid** how you obtained your answer. [2]

(f) On the grid, sketch the graph you would expect if Experiment 1 was repeated using more concentrated sulfuric acid. [1]

[Total: 10]

4 A student investigated the temperature changes when two different solids, **A** and **B**, dissolved in water.

Two sets of experiments were carried out.

Experiment 1

Using a measuring cylinder, 20 cm³ of distilled water was poured into a polystyrene cup. The temperature of the water was measured. 2 g of solid **A** was added to the cup and the mixture was stirred with a thermometer. The temperature of the solution was measured after one minute.

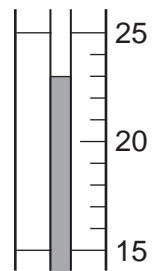

initial temperature

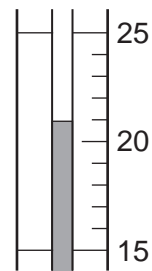

final temperature

The experiment was repeated using 3 g of solid **A**.

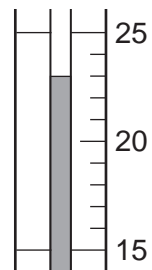

initial temperature

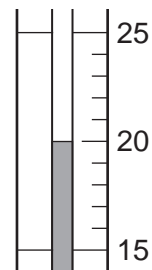

final temperature

The experiment was repeated using 4 g of solid **A**.

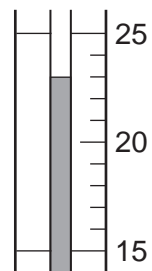

initial temperature

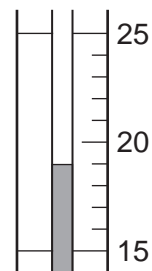

final temperature

The experiment was repeated using 6 g of solid A.

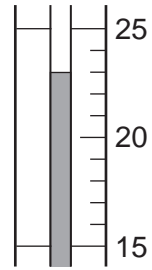

initial temperature

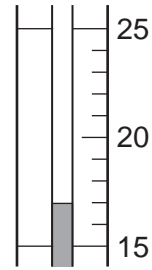

final temperature

- (a) Use the thermometer diagrams for Experiment 1 to record the initial and final temperatures in Table 4.1.

Table 4.1

mass of solid A/g	initial temperature/°C	final temperature/°C
2		
3		
4		
6		

[3]

Experiment 2

Experiment 1 was repeated using 2 g, 3 g and 4 g of solid B respectively.

2 g of B

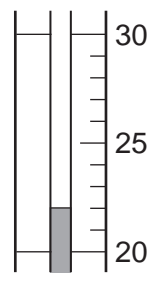

initial temperature

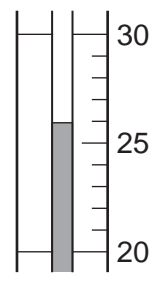

final temperature

3 g of B

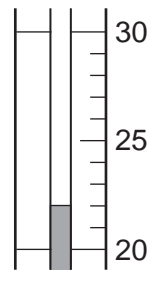

initial temperature

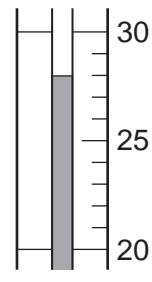

final temperature

4 g of B

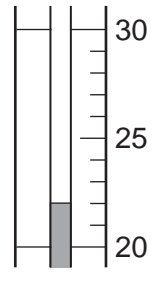

initial temperature

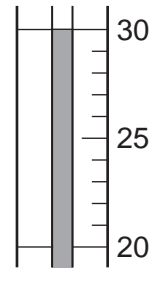

final temperature

(b) Use the thermometer diagrams for Experiment 2 to record the initial and final temperatures in Table 4.2.

Table 4.2

mass of solid B/g	initial temperature/°C	final temperature/°C
2		
3		
4		

[2]

(c) Plot the results of the experiments on the grid below. Draw two best-fit straight graphs. Clearly label your graphs.

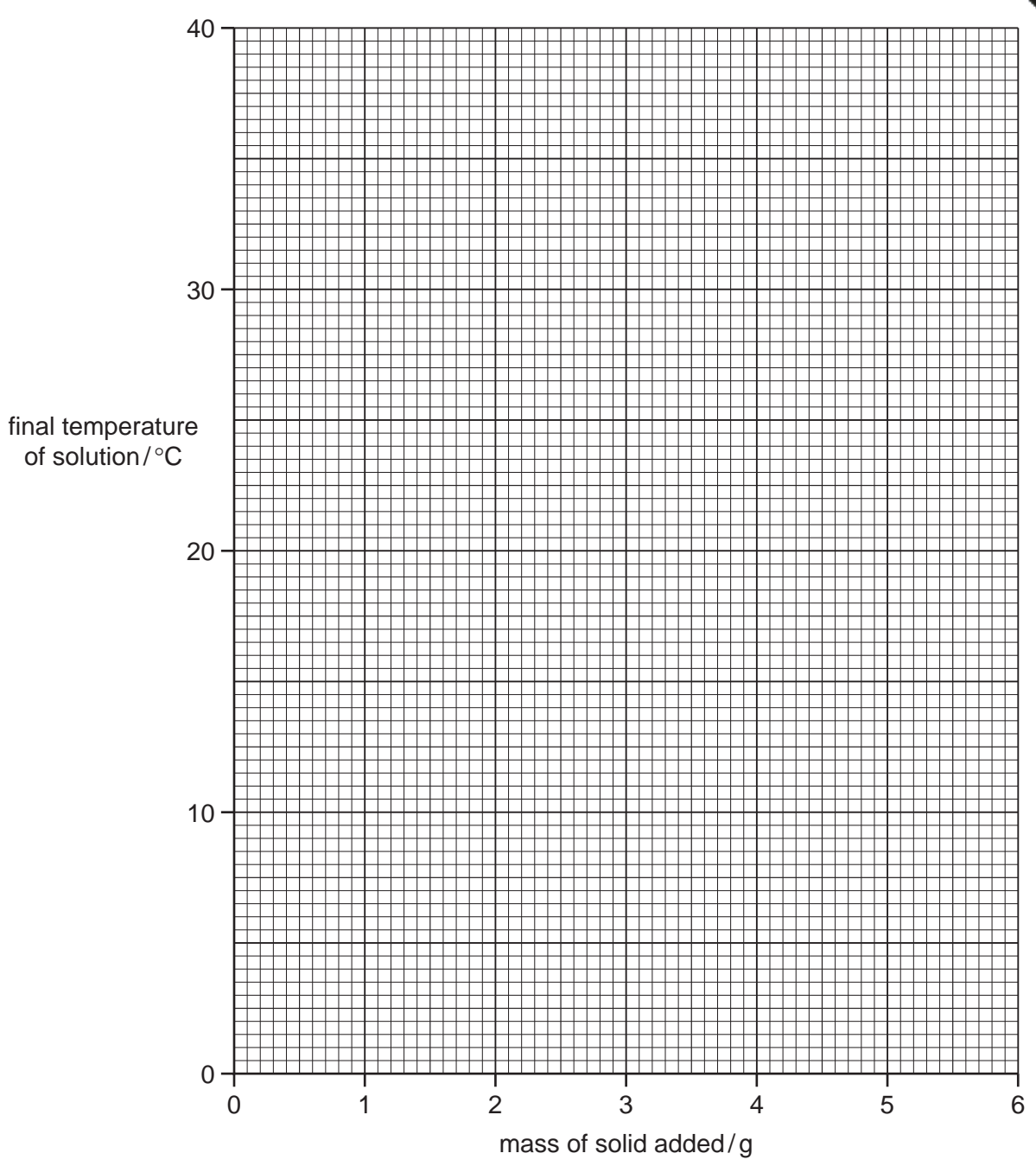

[6]

(d) (i) Use your graph to estimate the temperature of the reaction mixture if 6 g of solid B was added to 20 cm³ of water.

Show clearly on the grid how you worked out your answer.

..... [2]

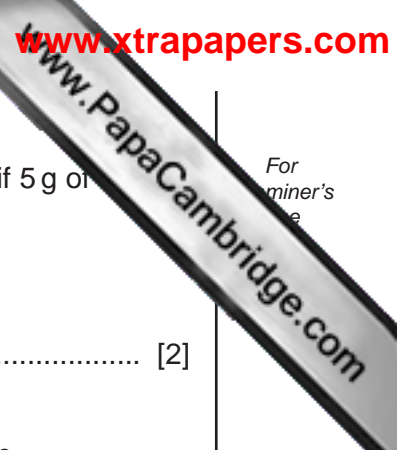

For
miner's
e

(ii) **From your graph** work out the temperature of the reaction mixture if 5 g of [unclear] was added to 20 cm³ of water.

Show clearly **on the graph** how you worked out your answer.

..... [2]

(e) What type of chemical reaction occurred when solid **A** dissolved in water?

..... [1]

(f) Explain how the temperature changes would differ in the experiments if 40 cm³ of water was used.

.....
.....
..... [2]

(g) Predict the effect of using lumps of solid **B** in Experiment 2. Explain your answer.

.....
..... [2]

[Total: 20]

5 A mixture of two solids, **C** and **D**, was analysed. Solid **C** was lead nitrate, which is water-soluble. Solid **D** was insoluble.

The tests on **C** and **D**, and some of the observations, are in the following table.

Complete the observations in the table.

tests	observations
<p>Water was added to the mixture in a boiling tube and shaken. The contents of the tube were filtered.</p> <p><u>tests on filtrate</u></p> <p>(a) To about 1 cm³ of the solution, a few drops of dilute nitric acid and about 1 cm³ of aqueous potassium iodide was added.</p> <p>(b) To about 1 cm³ of the solution, sodium hydroxide solution and aluminium powder were added. The mixture was heated. Any gases given off were tested with damp pH indicator paper.</p>	<p>..... [2]</p> <p>.....</p> <p>.....</p> <p>..... [3]</p>
<p><u>tests on residue</u></p> <p>(c) Dilute hydrochloric acid was added to the residue. The gas given off was tested with limewater.</p> <p>The solution was divided into two equal portions.</p> <p>(i) To the first portion, aqueous sodium hydroxide was added a little at a time until in excess.</p> <p>(ii) To the second portion, aqueous ammonia solution was added a little at a time until in excess.</p>	<p>rapid effervescence, limewater turns milky</p> <p>white precipitate, soluble in excess aqueous sodium hydroxide</p> <p>white precipitate, soluble in excess aqueous ammonia solution</p>

(d) Identify the gas given off in test (c).

..... [1]

(e) Identify solid **D**.

..... [2]

[Total: 8]

6 The apparatus below was used to deposit a thin layer of chromium on a steel knife. The knife was cleaned carefully and all grease removed before the process started.

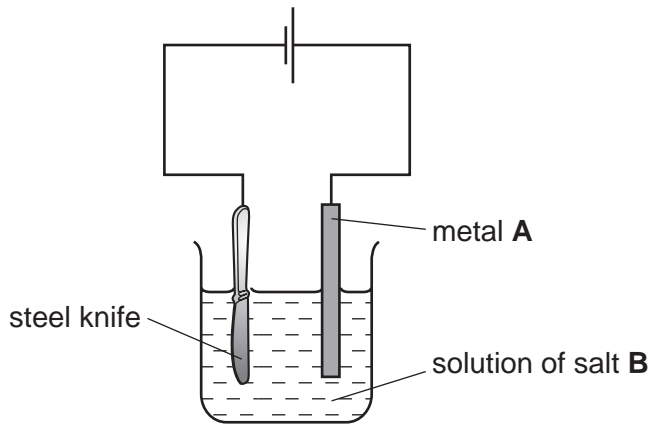

(a) What is the name of the process when metal objects are coated with other metals?
..... [1]

(b) (i) Suggest the identity of metal A.
..... [1]

(ii) Suggest the name of salt B.
..... [1]

(c) Give **two** reasons why steel knives are coated with chromium.
1.
2. [2]

[Total: 5]

7 Iron rusts when in contact with air and water.
You are provided with iron nails and three different samples of water:

- tap water,
- sea water,
- distilled water.

Plan an investigation to find out which sample of water causes iron to rust the fastest.

.....

.....

.....

.....

.....

.....

.....

.....

.....

.....[6]

[Total: 6]

