



Cambridge International Examinations
Cambridge International General Certificate of Secondary Education

CANDIDATE NAME

CENTRE NUMBER

CANDIDATE NUMBER

* 8 9 1 6 4 5 0 0 0 1 *

CHEMISTRY **0620/33**
Paper 3 (Extended) **October/November 2014**
1 hour 15 minutes

Candidates answer on the Question Paper.
No Additional Materials are required.

READ THESE INSTRUCTIONS FIRST

Write your Centre number, candidate number and name on all the work you hand in.
Write in dark blue or black pen.
You may use an HB pencil for any diagrams or graphs.
Do not use staples, paper clips, glue or correction fluid.
DO NOT WRITE IN ANY BARCODES.

Answer **all** questions.
Electronic calculators may be used.
A copy of the Periodic Table is printed on page 12.
You may lose marks if you do not show your working or if you do not use appropriate units.

At the end of the examination, fasten all your work securely together.
The number of marks is given in brackets [] at the end of each question or part question.

The syllabus is approved for use in England, Wales and Northern Ireland as a Cambridge International Level 1/Level 2 Certificate.

This document consists of **12** printed pages.

1 For each of the following elements give **one** physical property and **one** chemical property

(a) bromine (Br₂)

physical property

chemical property [2]

(b) carbon_{graphite} (C)

physical property

chemical property [2]

(c) manganese (Mn)

physical property

chemical property [2]

[Total: 6]

2 Compound X is a colourless liquid at room temperature.

(a) A sample of pure X was slowly heated from -5.0°C , which is below its melting point, to 90°C , which is above its boiling point. Its temperature is measured every minute and the results are represented on the graph.

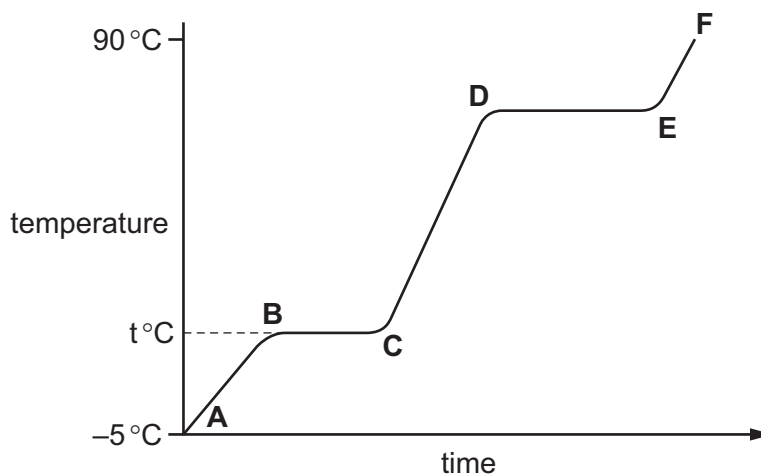

(i) Complete the equation for the equilibrium present in the region BC.



(ii) What is the significance of temperature $t^{\circ}\text{C}$?

..... [1]

(iii) What is the physical state of compound X in the region EF?

..... [1]

(iv) What would be the difference in the region BC if an impure sample of X had been used?

..... [1]

(b) Compound X is a hydrocarbon. It contains 85.7% of carbon. The mass of one mole of X is 84 g.

(i) What is the percentage of hydrogen in the compound ?

..... [1]

(ii) Calculate the empirical formula of X. Show your working.

empirical formula = [3]

(iii) What is the molecular formula of compound X?

..... [1]

[Total: 9]

3 In 1985 the fullerenes were discovered. They are solid forms of the element carbon. The structure of the C₆₀ fullerene is given below.

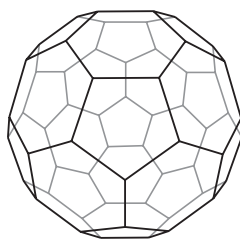

(a) (i) In the C₆₀ fullerene, how many other carbon atoms is each carbon atom bonded to?

..... [1]

(ii) Another fullerene has a relative molecular mass of 840. How many carbon atoms are there in one molecule of this fullerene?

..... [1]

(b) Fullerenes are soluble in liquid hydrocarbons such as octane. The other solid forms of carbon are insoluble. Describe how you could obtain crystals of fullerenes from soot which is a mixture of fullerenes and other solid forms of carbon.

.....
.....
.....
..... [3]

(c) A mixture of a fullerene and potassium is an excellent conductor of electricity.

(i) Which other form of solid carbon is a good conductor of electricity?

..... [1]

(ii) Explain why metals, such as potassium, are good conductors of electricity.

.....
..... [2]

(iii) The mixture of fullerene and potassium has to be stored out of contact with air. There are substances in unpolluted air which will react with potassium. Name **two** potassium compounds which could be formed when potassium is exposed to air.

..... [2]

[Total: 10]

- 4 A fuel cell produces electrical energy by the oxidation of a fuel by oxygen. The fuel is usually hydrogen but methane and methanol are two other fuels which may be used. A diagram of a hydrogen fuel cell is given below.

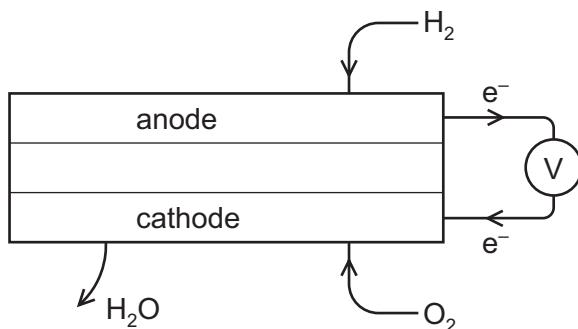

- (a) When the fuel is hydrogen, the only product is water. What additional product would be formed if methane was used?

..... [1]

- (b) Write the equation for the chemical reaction that takes place in a hydrogen fuel cell.

..... [1]

- (c) (i) At which electrode does oxidation occur? Explain your choice.

..... [1]

- (ii) Write an ionic equation for the reaction at this electrode.

..... [2]

- (d) Fuel cells are used to propel cars. Give **two** advantages of a fuel cell over a gasoline-fuelled engine.

.....
 [2]

[Total: 7]

- 5 (a) Sodium chlorate(I) decomposes to form sodium chloride and oxygen. The rate of reaction is very slow at room temperature provided the sodium chlorate(I) is stored in a dark container to prevent exposure to light.

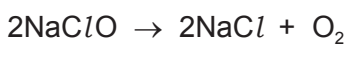

The rate of this decomposition can be studied using the following experiment.

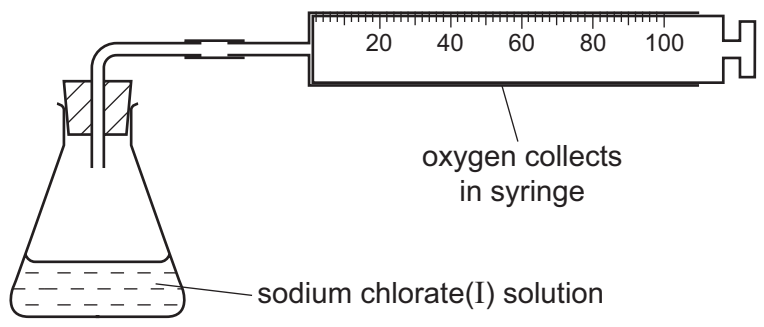

Sodium chlorate(I) is placed in the flask and 0.2 g of copper(II) oxide is added. This catalyses the decomposition of the sodium chlorate(I) and the volume of oxygen collected is measured every minute. The results are plotted to give a graph of the type shown below.

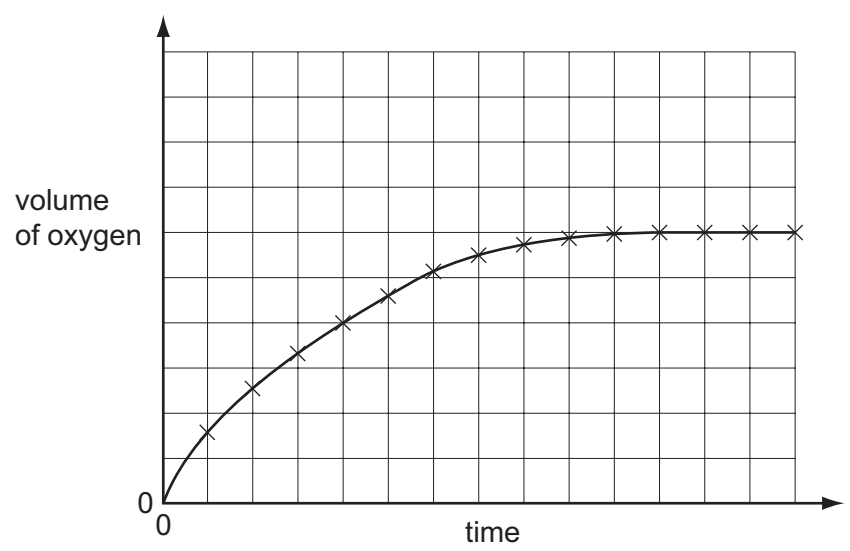

- (i) Explain why the gradient (slope) of this graph decreases with time.
-
- [2]
- (ii) Cobalt(II) oxide is a more efficient catalyst for this reaction than copper(II) oxide. Sketch, on the grid, the graph for the reaction catalysed by cobalt(II) oxide. All other conditions were kept constant. [2]

(iii) What can you deduce from the comment that sodium chlorate(I) has to be stored in the dark?
light?

.....
..... [1]

(iv) Explain, in terms of collisions between particles, why the initial gradient would be steeper if the experiment was repeated at a higher temperature.

.....
.....
.....
..... [3]

(b) The ions present in aqueous sodium chloride are Na⁺(aq), Cl⁻(aq), H⁺(aq) and OH⁻(aq).

The electrolysis of concentrated aqueous sodium chloride forms three products. They are hydrogen, chlorine and sodium hydroxide.

(i) Explain how these **three** products are formed. Give ionic equations for the reactions at the electrodes.

.....
.....
.....
.....
..... [4]

(ii) If the solution of the electrolyte is stirred, chlorine reacts with sodium hydroxide to form sodium chlorate(I), sodium chloride and water.
Write an equation for this reaction.

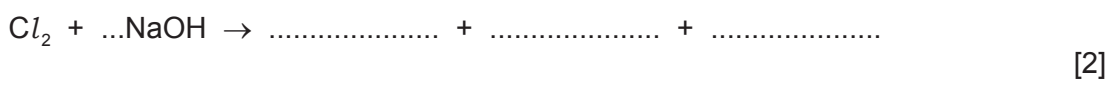

[Total: 14]

6 Rubidium and strontium are very reactive metals at the top of the reactivity series. Both form ions with different charges, their compounds behave differently when heated.

(a) The formulae of the ions of these two elements are Rb⁺ and Sr²⁺. Explain why these metals, which are in different groups, form ions which have different charges.

.....
..... [2]

(b) Strontium carbonate is similar to calcium carbonate. It is insoluble in water and it decomposes when heated. Rubidium carbonate is soluble in water and does not decompose when heated.

(i) Describe a method to prepare a pure sample of the insoluble salt, strontium carbonate, by precipitation.

.....
.....
.....
.....
..... [4]

(ii) Complete the equation for the decomposition of strontium carbonate.



(c) Metal nitrates decompose when heated.

(i) Rubidium nitrate decomposes as follows:



What is the name of the compound RbNO₂?

..... [1]

(ii) The nitrates of most other metals decompose in a different way. Complete the equation for the decomposition of strontium nitrate.

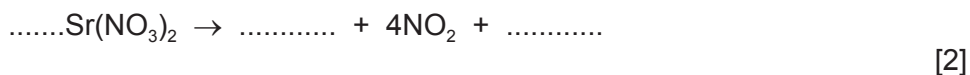

[Total: 10]

7 Butane is oxidised to a mixture of carboxylic acids by oxygen in the presence of a catalyst. The acids formed are methanoic acid, ethanoic acid and propanoic acid – the first three members of the carboxylic acid homologous series.

(a) (i) Give the name and structural formula of the fourth member of this series.

name

structural formula showing all the atoms and bonds

[3]

(ii) State **three** characteristics of a homologous series.

.....

.....

..... [3]

(iii) All members of this series are weak acids.

What is meant by the term *weak acid*?

.....

.....

..... [3]

(b) Carboxylic acids react with alcohols to form esters. Ethanol reacts with ethanoic acid to form the ester ethyl ethanoate, CH₃COOCH₂CH₃.

(i) Give the name and formula of the ester which is formed from methanol and propanoic acid.

name

formula

[2]

(ii) What is the name of the ester which has the formula CH₃COOCH₃?

..... [1]

10

(c) (i) Complete the equation for the oxidation of butane to propanoic acid.



(ii) Name **another** compound which can be oxidised to propanoic acid.

..... [1]

[Total: 14]

8 (a) Describe how cobalt chloride paper can be used to test for the presence of water

.....
.....

(b) Complete the description of the preparation of crystals of the soluble salt, cobalt(II) chloride-6-water, $\text{CoCl}_2 \cdot 6\text{H}_2\text{O}$, from the insoluble base, cobalt(II) carbonate.



50 cm³ of dilute hydrochloric acid, concentration 2.2 mol/dm³, was heated and cobalt(II) carbonate was added in small amounts until

.....
.....
.....
.....

[4]

(c) 6.31 g of cobalt(II) chloride-6-water crystals were obtained. Calculate the percentage yield to 1 decimal place.

number of moles of HCl in 50 cm³ of acid, concentration 2.2 mol/dm³ =

maximum number of moles of $\text{CoCl}_2 \cdot 6\text{H}_2\text{O}$ which could be formed =

mass of 1 mole of $\text{CoCl}_2 \cdot 6\text{H}_2\text{O}$ = 238 g

maximum yield of $\text{CoCl}_2 \cdot 6\text{H}_2\text{O}$ = g

percentage yield =%

[4]

[Total: 10]

DATA SHEET
The Periodic Table of the Elements

		Group																		
I	II	III	IV	V	VI	VII	0													
7 Li Lithium 3	9 Be Beryllium 4	1 H Hydrogen 1	11 B Boron 5	12 C Carbon 6	14 N Nitrogen 7	16 O Oxygen 8	19 F Fluorine 9	20 Ne Neon 10												
23 Na Sodium 11	24 Mg Magnesium 12	27 Al Aluminium 13	28 Si Silicon 14	31 P Phosphorus 15	32 S Sulfur 16	35.5 Cl Chlorine 17	40 Ar Argon 18													
39 K Potassium 19	40 Ca Calcium 20	45 Sc Scandium 21	48 Ti Titanium 22	51 V Vanadium 23	52 Cr Chromium 24	55 Mn Manganese 25	56 Fe Iron 26	59 Co Cobalt 27	59 Ni Nickel 28	64 Cu Copper 29	65 Zn Zinc 30	70 Ga Gallium 31	73 Ge Germanium 32	75 As Arsenic 33	79 Se Selenium 34	80 Br Bromine 35	84 Kr Krypton 36			
85 Rb Rubidium 37	88 Sr Strontium 38	89 Y Yttrium 39	91 Zr Zirconium 40	93 Nb Niobium 41	96 Mo Molybdenum 42	101 Ru Ruthenium 44	101 Rh Rhodium 45	103 Rh Rhodium 45	106 Pd Palladium 46	108 Ag Silver 47	112 Cd Cadmium 48	115 In Indium 49	119 Sn Tin 50	122 Sb Antimony 51	128 Te Tellurium 52	127 I Iodine 53	131 Xe Xenon 54			
133 Cs Caesium 55	137 Ba Barium 56	139 La Lanthanum 57	178 Hf Hafnium 72	181 Ta Tantalum 73	184 W Tungsten 74	190 Os Osmium 76	192 Ir Iridium 77	192 Ir Iridium 77	195 Pt Platinum 78	197 Au Gold 79	201 Hg Mercury 80	204 Tl Thallium 81	207 Pb Lead 82	209 Bi Bismuth 83	212 Po Polonium 84	210 At Astatine 85	222 Rn Radon 86			
87 Fr Francium	226 Ra Radium	227 Ac Actinium																		

140 Ce Cerium 58	141 Pr Praseodymium 59	144 Nd Neodymium 60	150 Sm Samarium 62	152 Eu Europium 63	157 Gd Gadolinium 64	162 Dy Dysprosium 66	165 Ho Holmium 67	167 Er Erbium 68	169 Tm Thulium 69	173 Yb Ytterbium 70	175 Lu Lutetium 71
232 Th Thorium 90	238 U Uranium 92	238 Pa Protactinium 91	238 Pu Plutonium 94	238 Am Americium 95	238 Cm Curium 96	238 Cf Californium 98	238 Es Einsteinium 99	238 Fm Fermium 100	238 Md Mendelevium 101	238 No Nobelium 102	238 Lr Lawrencium 103

a	X
b	

a = relative atomic mass
X = atomic symbol
b = proton (atomic) number

*58-71 Lanthanoid series
†90-103 Actinoid series

The volume of one mole of any gas is 24 dm³ at room temperature and pressure (r.t.p.).

Permission to reproduce items where third-party owned material protected by copyright is included has been sought and cleared where possible. Every reasonable effort has been made by the publisher (UCLES) to trace copyright holders, but if any items requiring clearance have unwittingly been included the publisher will be pleased to make amends at the earliest possible opportunity.

Cambridge International Examinations is part of the Cambridge Assessment Group. Cambridge Assessment is the brand name of University of Cambridge Local Examinations Syndicate (UCLES), which is itself a department of the University of Cambridge.