



UNIVERSITY OF CAMBRIDGE INTERNATIONAL EXAMINATIONS
International General Certificate of Secondary Education

CANDIDATE
NAME

CENTRE
NUMBER

--	--	--	--	--

CANDIDATE
NUMBER

--	--	--	--

* 6 5 5 3 9 7 2 0 4 5 *

CAMBRIDGE INTERNATIONAL MATHEMATICS

0607/03

Paper 3 (Core)

October/November 2011

1 hour 45 minutes

Candidates answer on the Question Paper

Additional Materials: Geometrical Instruments
Graphics Calculator

READ THESE INSTRUCTIONS FIRST

Write your Centre number, candidate number and name on all the work you hand in.

Write in dark blue or black pen.

Do not use staples, paper clips, highlighters, glue or correction fluid.

You may use a pencil for any diagrams or graphs.

DO NOT WRITE IN ANY BARCODES.

Answer **all** the questions.

Unless instructed otherwise, give your answers exactly or correct to three significant figures as appropriate.

Answers in degrees should be given to one decimal place.

For π , use your calculator value.

You must show all the relevant working to gain full marks and you will be given marks for correct methods, including sketches, even if your answer is incorrect.

The number of marks is given in brackets [] at the end of each question or part question.

The total number of marks for this paper is 96.

For Examiner's Use

--

This document consists of **16** printed pages.



Formula List

Area, A , of triangle, base b , height h .

$$A = \frac{1}{2}bh$$

Area, A , of circle, radius r .

$$A = \pi r^2$$

Circumference, C , of circle, radius r .

$$C = 2\pi r$$

Curved surface area, A , of cylinder of radius r , height h .

$$A = 2\pi rh$$

Curved surface area, A , of cone of radius r , sloping edge l .

$$A = \pi rl$$

Curved surface area, A , of sphere of radius r .

$$A = 4\pi r^2$$

Volume, V , of prism, cross-sectional area A , length l .

$$V = Al$$

Volume, V , of pyramid, base area A , height h .

$$V = \frac{1}{3}Ah$$

Volume, V , of cylinder of radius r , height h .

$$V = \pi r^2 h$$

Volume, V , of cone of radius r , height h .

$$V = \frac{1}{3}\pi r^2 h$$

Volume, V , of sphere of radius r .

$$V = \frac{4}{3}\pi r^3$$

Answer **all** the questions.

- 1 A bookcase is **full** of books.
One shelf holds exactly 35 books.
Each book is 3.2 cm wide.

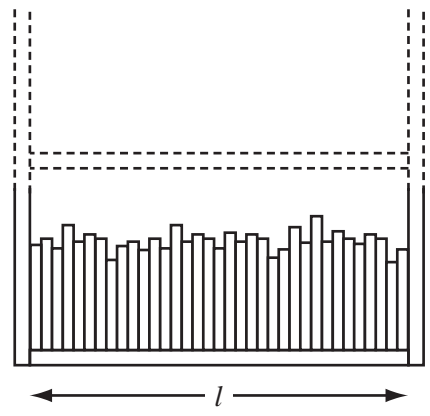

- (a) Calculate l , the length of one shelf.

Answer(a) $l =$ cm [1]

- (b) The bookcase contains 6 of these shelves.

Calculate the total number of books in the bookcase.

Answer(b) [1]

- (c) The books cost \$6 each or \$9 each.
The ratio of \$6 books to \$9 books in the bookcase is 6 : 9.

- (i) Write this ratio in its simplest form.

Answer(c)(i) : [1]

- (ii) Find the number of \$6 books in the bookcase.

Answer(c)(ii) [2]

- (iii) Find the **total** cost of all the books in the bookcase.

Answer(c)(iii) \$ [2]

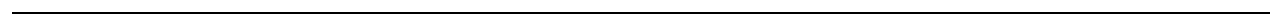

2 The monthly wages, in dollars, of 10 people are listed below.

1000	1400	1100	900	1050
1500	900	800	950	1300

(a) Calculate the mean.

Answer(a) \$ [1]

(b) Write down the mode.

Answer(b) \$ [1]

(c) Find the range.

Answer(c) \$ [1]

(d) Calculate the percentage of these people with wages greater than \$1100.

Answer(d) % [2]

(e) One person is chosen at random.

Find the probability that this person's wage is less than \$1100.

Answer(e) [1]

(f) The largest wages, \$1500, \$1400 and \$1300 are removed from the list.

Find the median of the remaining seven wages.

Answer(f) \$ [1]



3 (a) Expand and simplify.

$$2(x - 3) + 3(2x + 4)$$

Answer(a) [3]

(b) Factorise completely.

$$3x^2 - 9xy$$

Answer(b) [2]

(c) Solve the equation.

$$3x + 5 = x + 12$$

Answer(c) $x =$ [2]

(d) If $a = 3$ and $b = -2$ find the value of $2a - 3b$.

Answer(d) [2]

4 (a) On the axes, sketch the graph of the function $y = x^2 - 4$ for $-3 \leq x \leq 3$.

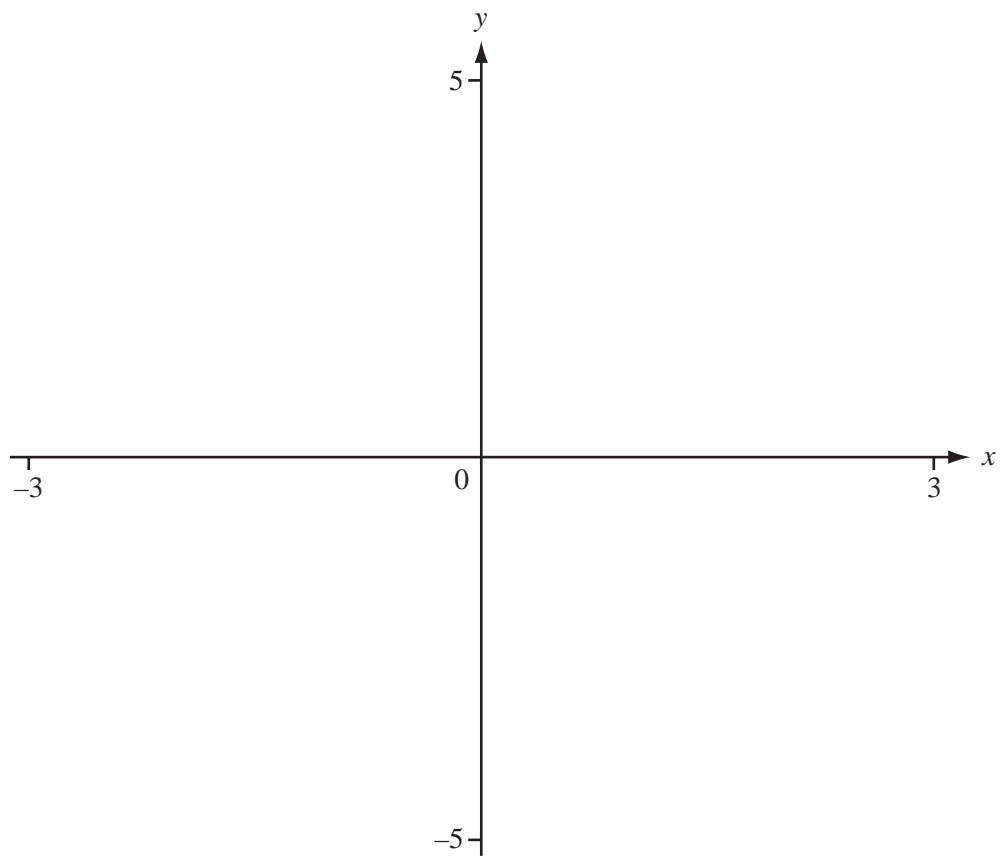

[2]

(b) Write down the co-ordinates of the minimum point of this graph.

Answer(b) (..... ,) [1]

(c) Write down the equation of the line of symmetry of this graph.

Answer(c) [1]

(d) Write down the range of this function.

Answer(d) [1]

(e) Write down the co-ordinates of the zeros of this function.

Answer(e) (..... ,) and (..... ,) [2]

(f) On the same axes, sketch the graph of $y = \frac{1}{2}x + 2$ for $-3 \leq x \leq 3$.

(g) Find the co-ordinates of the points where $x^2 - 4 = \frac{1}{2}x + 2$.

Give each answer correct to 2 decimal places.

Answer(g) (..... ,)

(..... ,) [2]

5 Surya has \$5000 in her bank account.
The bank pays interest at a rate of 3% each year.

(a) Find how much interest Surya receives at the end of the first year.

Answer(a) \$ [2]

(b) Surya does not remove the interest from her account.

Show that the **total** amount of money in her account at the end of the second year is \$5304.50.

[2]

(c) Surya does not remove any money from her account.

(i) Calculate the **total** amount of money in her account at the end of the fourth year.

Answer(c)(i) \$ [2]

(ii) Find the **total interest** she receives.

Answer(c)(ii) \$ [1]

6 One kilogram of apples costs \$ x .
One kilogram of oranges costs \$ y .

(a) Write down the cost, in terms of x , of 6 kg of apples.

Answer(a) \$ [1]

(b) Sami buys 6 kg of apples and 4 kg of oranges.
The total cost is \$27.

Use this information to write down an equation in x and y .

Answer(b) [1]

(c) Terri buys 2 kg of apples and 3 kg of oranges.
The total cost is \$14.

Use this information to write down an equation in x and y .

Answer(c) [1]

(d) Solve the two equations to find the cost of 1 kg of apples and the cost of 1 kg of oranges.
Show all your working.

Answer(d) 1 kg of apples costs \$

1 kg of oranges costs \$ [3]

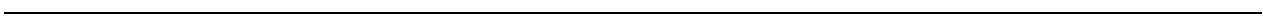

7 A ship sails 50 km from a point S to a point A on a bearing of 040° .

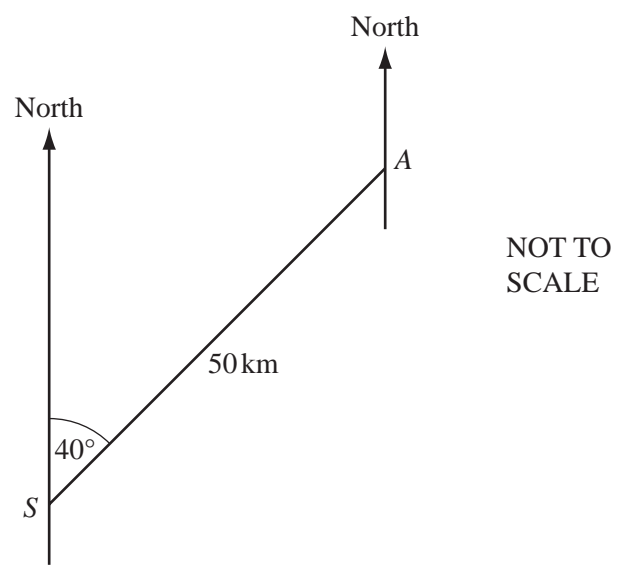

(a) The ship took 2 hours 30 minutes to sail from S to A .
Find the average speed of the ship in km/h.

Answer(a) km/h [1]

(b) Calculate the distance that A is north of S .

Answer(b) km [3]

(c) Find the bearing of S from A .

Answer(c) [1]

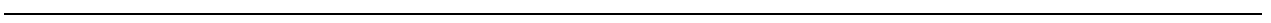

8 (a)

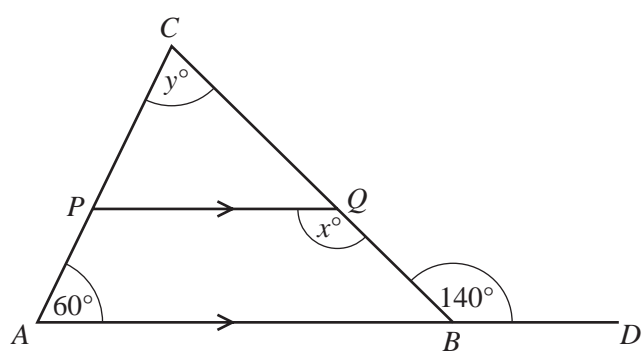

NOT TO
SCALE

The diagram shows a triangle ABC .
 AB is parallel to PQ and ABD is a straight line.
Angle $CAB = 60^\circ$ and angle $CBD = 140^\circ$.

Find the values of x and y .

Answer(a) $x =$

$y =$ [2]

(b)

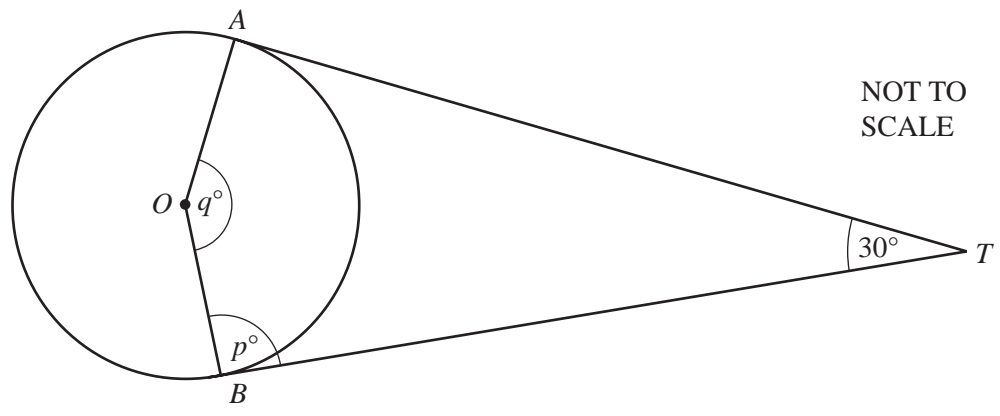

NOT TO
SCALE

TA and TB are tangents at A and B to the circle, centre O .
Angle $ATB = 30^\circ$.

Find the values of p and q .

Answer(b) $p =$

$q =$ [2]

(c)

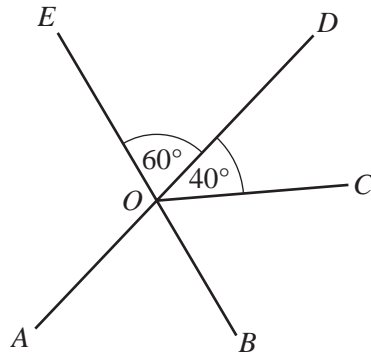

NOT TO
SCALE

The straight lines AD and BE cross at O .
Angle $COD = 40^\circ$ and angle $DOE = 60^\circ$.

Find the size of

(i) angle AOB ,

Answer(c)(i) [1]

(ii) angle AOE ,

Answer(c)(ii) [1]

(iii) angle BOC .

Answer(c)(iii) [1]

(d)

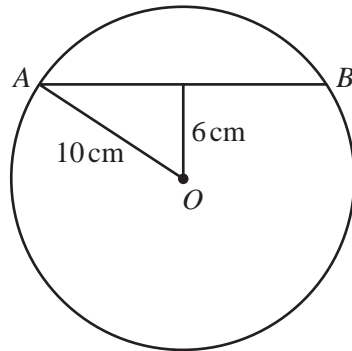

NOT TO
SCALE

The diagram shows a circle, radius 10 cm, centre O .
A chord AB is drawn so that its midpoint is 6 cm from O .

Calculate the length of the chord AB .

Answer(d) cm [4]

9 The cumulative frequency curve shows the marks that students scored in an examination.

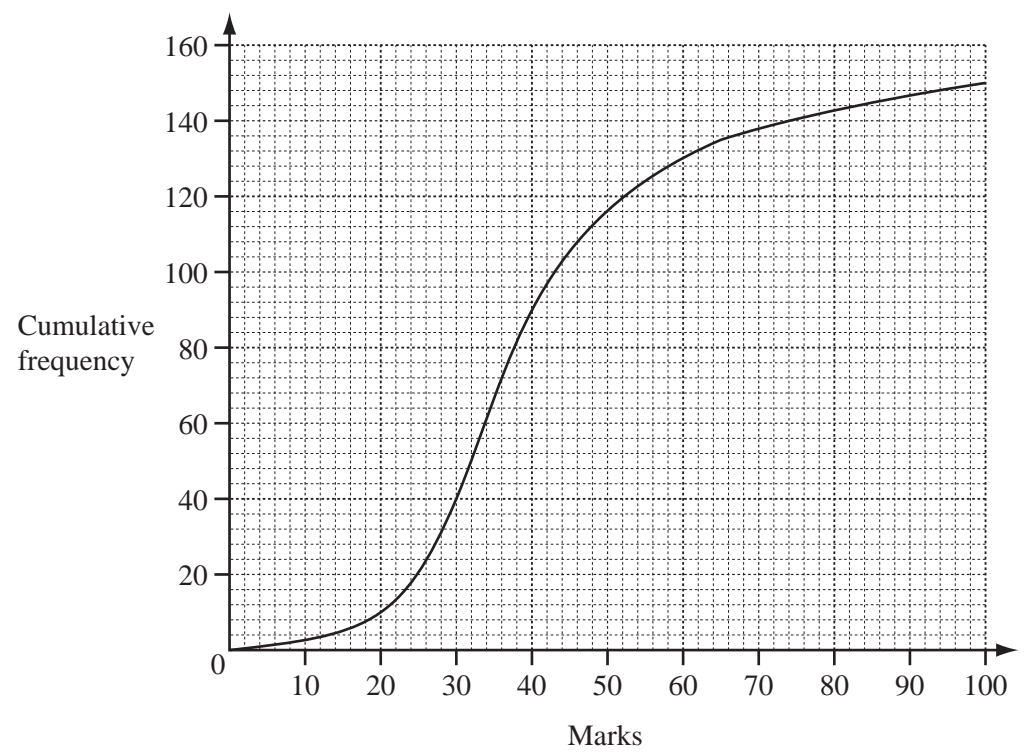

(a) Write down how many students took the examination.

Answer(a) [1]

(b) Find how many students scored less than 60 marks.

Answer(b) [1]

(c) The top 10% of students received a prize.

(i) Find how many students received a prize.

Answer(c)(i) [1]

(ii) Find the lowest possible mark for receiving a prize.

Answer(c)(ii) [2]



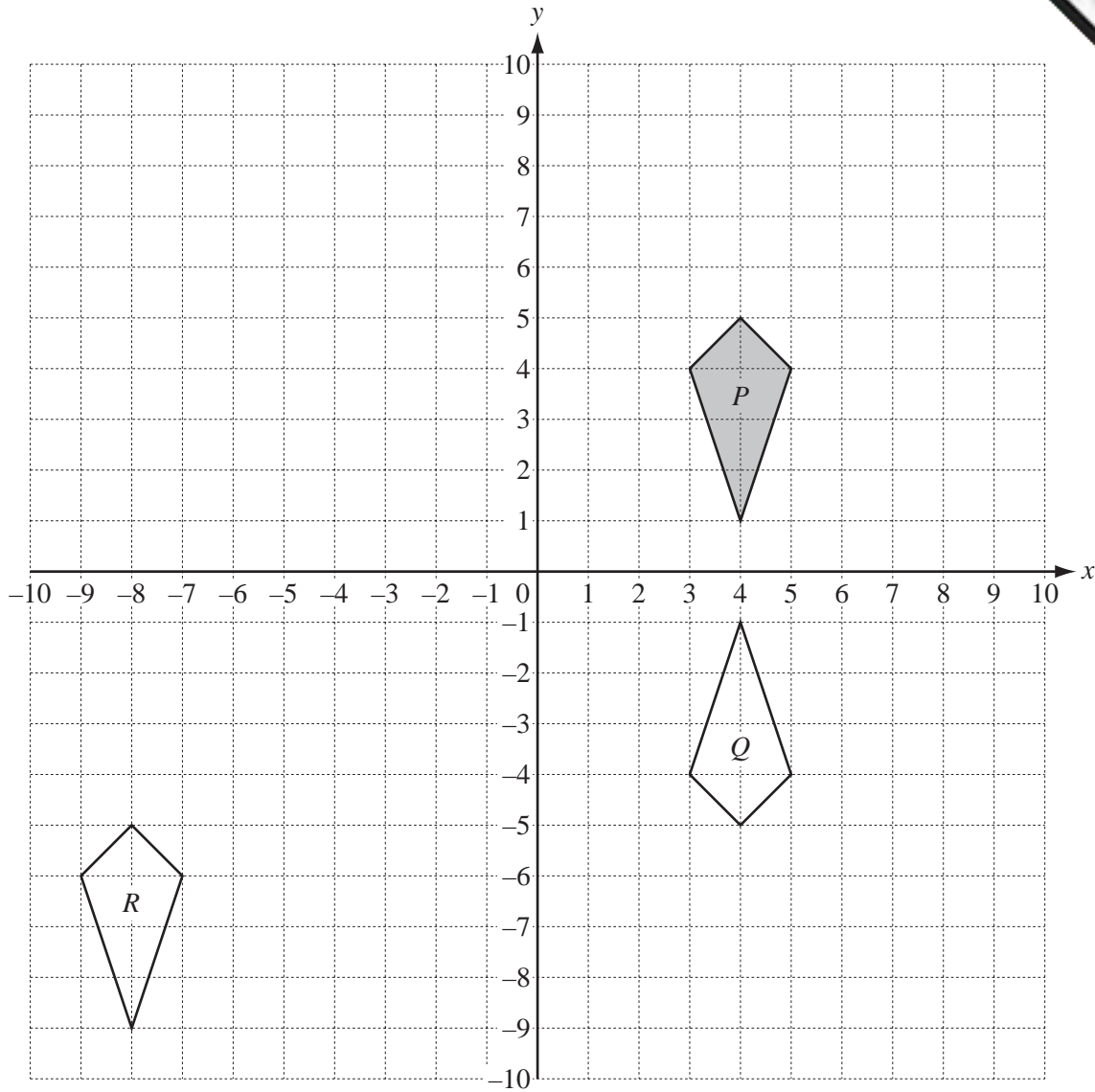

A quadrilateral P is drawn on the grid.

- (a) Write down the geometrical name for the quadrilateral P .

Answer(a) [1]

- (b) Describe fully the **single** transformation that maps P onto Q .

..... [2]

- (c) Describe fully the **single** transformation that maps P onto R .

..... [2]

- (d) On the grid, draw the image of P after a rotation of 90° anticlockwise about $(0, 0)$. [2]

- (e) On the grid, draw the image of P after an enlargement centre $(0, 0)$, scale factor 2. [2]

11

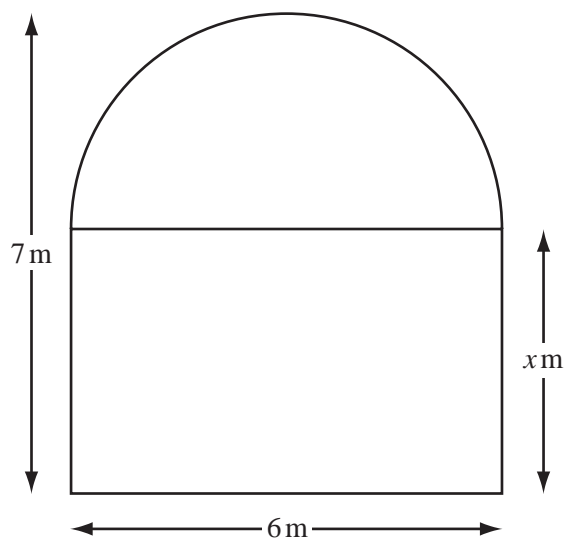

NOT TO SCALE

A train tunnel is in the shape of a semicircle on top of a rectangle.
 The width of the tunnel is 6 m.
 The total height of the tunnel is 7 m.

(a) (i) Find the radius of the semicircle.

Answer(a)(i) m [1]

(ii) Find the value of x.

Answer(a)(ii) x = [1]

(b) Calculate the area of the rectangle.

Answer(b) m² [1]

(c) Calculate the area of the semicircle.
 Give your answer correct to 2 significant figures.

Answer(c) m² [3]

(d) The length of the tunnel is 35 kilometres.

Calculate the volume of earth, in **cubic metres**, that was removed to make the tunnel.

Answer(d) m³ [2]

(e) A train travels at an average speed of 105 km/h through the tunnel.

(i) Calculate the time, in minutes, it takes the train to travel through the tunnel.

Answer(e)(i) minutes [2]

(ii) The train enters the tunnel at 11 10.
It arrives at the next station at 12 02.

Find the number of minutes between the train leaving the tunnel and arriving at the station.

Answer(e)(ii) minutes [2]

Question 12 is printed on the next page.

