

Centre Number	Candidate Number	Name
---------------	------------------	------

CAMBRIDGE INTERNATIONAL EXAMINATIONS
International General Certificate of Secondary Education

PHYSICS

0625/03

Paper 3

October/November 2003

1 hour 15 minutes

Candidates answer on the Question Paper.
No Additional Materials are required.

READ THESE INSTRUCTIONS FIRST

Write your Centre number, candidate number and name on all the work you hand in.
Write in dark blue or black pen in the spaces provided on the Question Paper.
You may use a soft pencil for any diagrams, graphs or rough working.
Do not use staples, paper clips, highlighters, glue or correction fluid.

Answer **all** questions.
At the end of the examination, fasten all your work securely together.
The number of marks is given in brackets [] at the end of each question or part question.
You may lose marks if you do not show your working or if you do not use appropriate units.
Take the weight of 1 kg to be 10 N (i.e. acceleration of free fall = 10 m/s²).

For Examiner's Use	
1	
2	
3	
4	
5	
6	
7	
8	
9	
10	
11	
Total	

If you have been given a label, look at the details. If any details are incorrect or missing, please fill in your correct details in the space given at the top of this page.

Stick your personal label here, if provided.

1 Fig. 1.1 shows the speed-time graph for a bus during tests.

At time $t = 0$, the driver starts to brake.

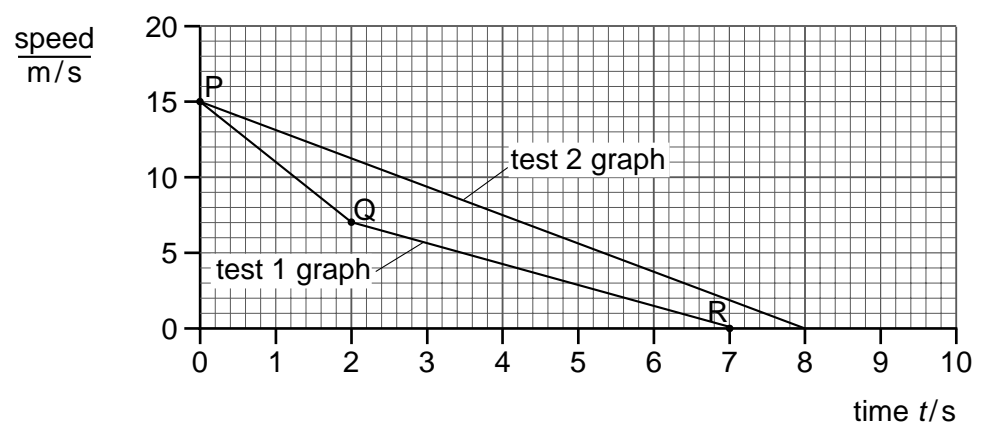

Fig. 1.1

(a) For test 1,

(i) determine how long the bus takes to stop,

.....

(ii) state which part of the graph shows the greatest deceleration,

.....

(iii) use the graph to determine how far the bus travels in the first 2 seconds.

distance =
[4]

(b) For test 2, a device was fitted to the bus. The device changed the deceleration.

(i) State two ways in which the deceleration during test 2 is different from that during test 1.

1

2

(ii) Calculate the value of the deceleration in test 2.

deceleration =

(c) Fig. 1.2 shows a sketch graph of the magnitude of the acceleration for the bus as it is travelling around a circular track at constant speed.

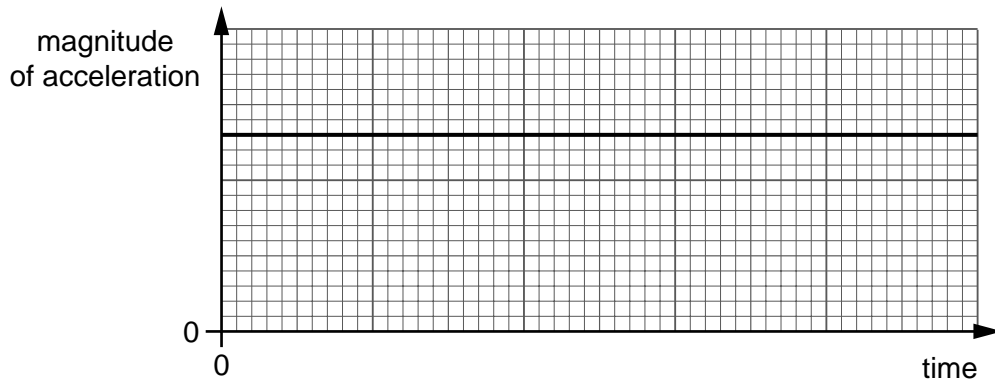

Fig. 1.2

(i) Use the graph to show that there is a force of constant magnitude acting on the bus.

.....
.....

(ii) State the direction of this force.

.....

[3]

2 Fig. 2.1 shows a diver 50 m below the surface of the water.

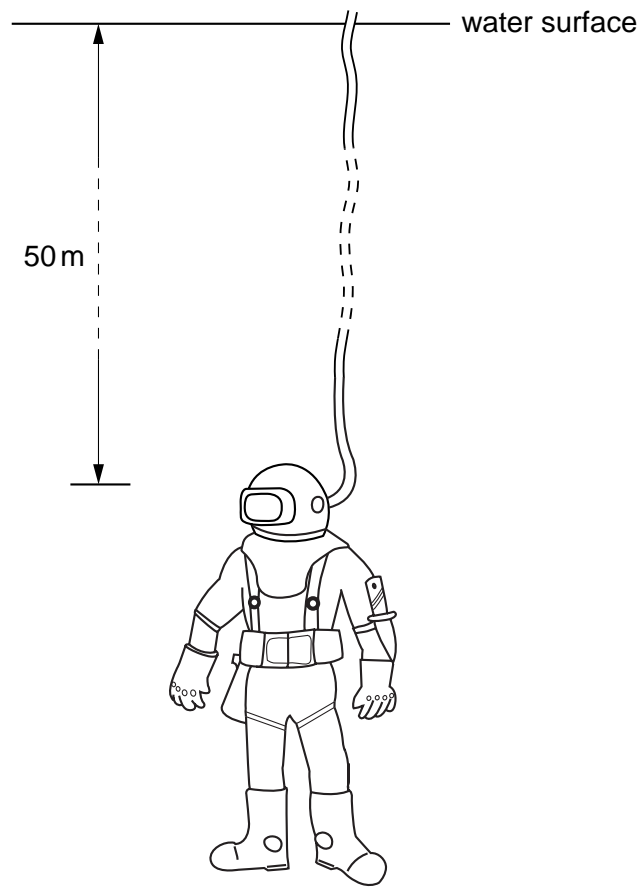

Fig. 2.1

(a) The density of water is 1000 kg/m^3 and the acceleration of free fall is 10 m/s^2 . Calculate the pressure that the water exerts on the diver.

pressure = [3]

(b) The window in the diver's helmet is 150 mm wide and 70 mm from top to bottom.

Calculate the force that the water exerts on this window.

force = [3]

- 3 Fig. 3.1 shows a simple see-saw. One child A sits near to end X and another child B sits near to end Y. The feet of the children do not touch the ground when the see-saw is balanced.

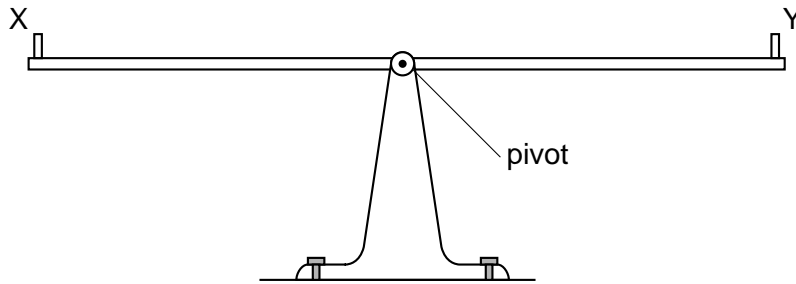

Fig. 3.1

- (a) Child A has a mass of 18.0 kg and child B has a mass of 20.0 kg.

Without calculation, indicate where the children could sit so that the see-saw balances horizontally. You may draw on Fig. 3.1 if you wish.

.....

 [2]

- (b) State the relationship between the moment caused by child A and that caused by child B.

.....
 [1]

- (c) Child A is 2.50 m from the pivot. Calculate the distance of child B from the pivot.

distance = [2]

- 4 Fig. 4.1 shows water being heated by an electrical heater. The water in the can is boiling, but some is evaporating.

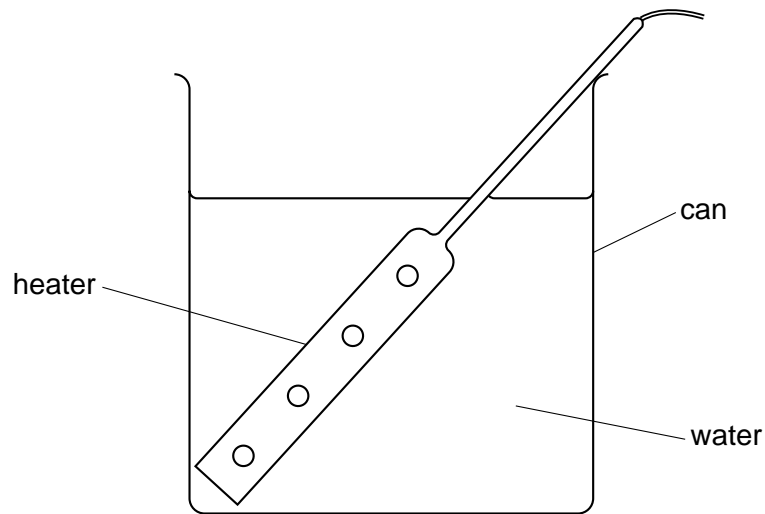

Fig. 4.1

- (a) Describe, in terms of the movement and energies of the water molecules, how evaporation takes place.

.....

 [2]

- (b) State two differences between evaporation and boiling.

1

 2
 [2]

- (c) After the water has reached its boiling point, the mass of water in the can is reduced by 3.2 g in 120 s. The heater supplies energy to the water at a rate of 60 W. Use this information to calculate the specific latent heat of vaporisation of water.

specific latent heat = [3]

- 5 (a) Equal volumes of nitrogen, water and copper at 20 °C are heated to 50 °C.
- (i) Which one of the three will have a much greater expansion than the other two?

.....

- (ii) Explain your answer in terms of the way the molecules are arranged in the three substances.

.....

.....

.....

[3]

- (b) Fig. 5.1 shows a thermometer with a range of -10 °C to 50 °C.



Fig. 5.1

Explain what is meant by

- (i) the *sensitivity* of a thermometer,

.....

.....

- (ii) the *linearity* of a thermometer.

.....

.....

[2]

6 Fig. 6.1 shows the diffraction of waves by a narrow gap.

P is a wavefront that has passed through the gap.

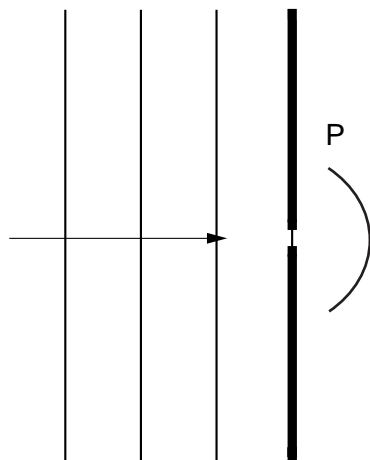

Fig. 6.1

(a) On Fig. 6.1, draw three more wavefronts to the right of the gap. [3]

(b) The waves travel towards the gap at a speed of 3×10^8 m/s and have a frequency of 5×10^{14} Hz. Calculate the wavelength of these waves.

wavelength = [3]

7 Fig. 7.1 is drawn to full scale. The focal length of the lens is 5.0 cm.

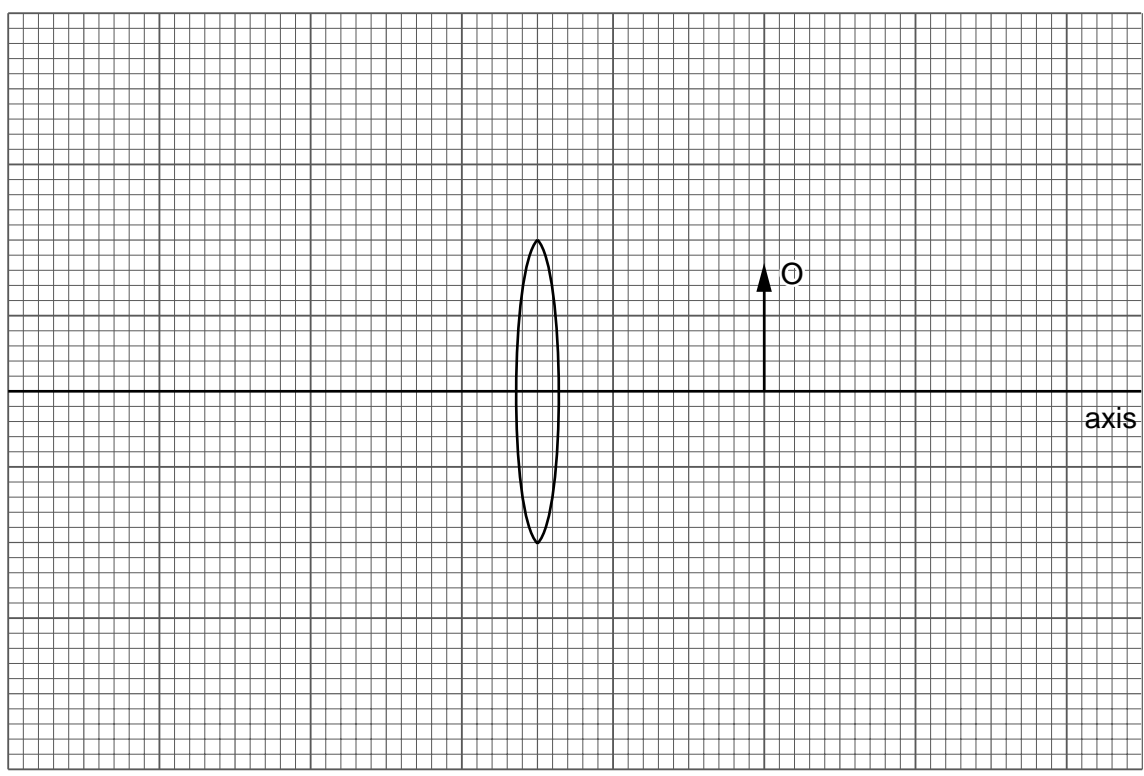

Fig. 7.1

- (a) On Fig. 7.1, mark each principal focus of the lens with a dot and the letter F. [2]
- (b) On Fig. 7.1, draw **two** rays from the tip of the object O that appear to pass through the tip of the image. [2]
- (c) On Fig. 7.1, draw the image and label it with the letter I. [1]
- (d) Explain why the base of the image lies on the axis.
.....
..... [1]
- (e) State a practical use of a convex lens when used as shown in Fig. 7.1.
..... [1]

- 8 Fig. 8.1 shows the outline of an a.c. generator. The peak output voltage of the generator is 6.0 V and the output has a frequency of 10 Hz.

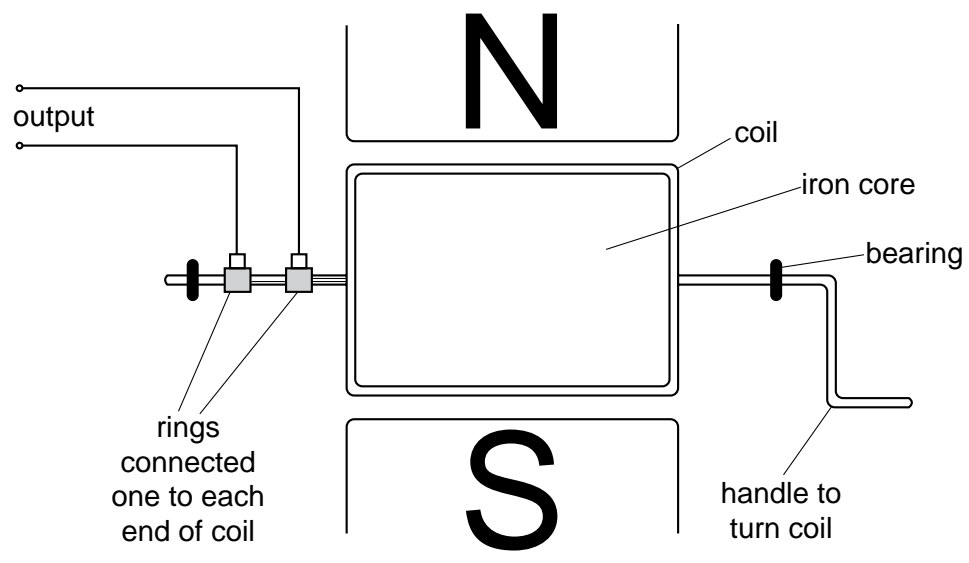

Fig. 8.1

- (a) Fig. 8.2 shows the axes of a voltage-time graph for the generator output.

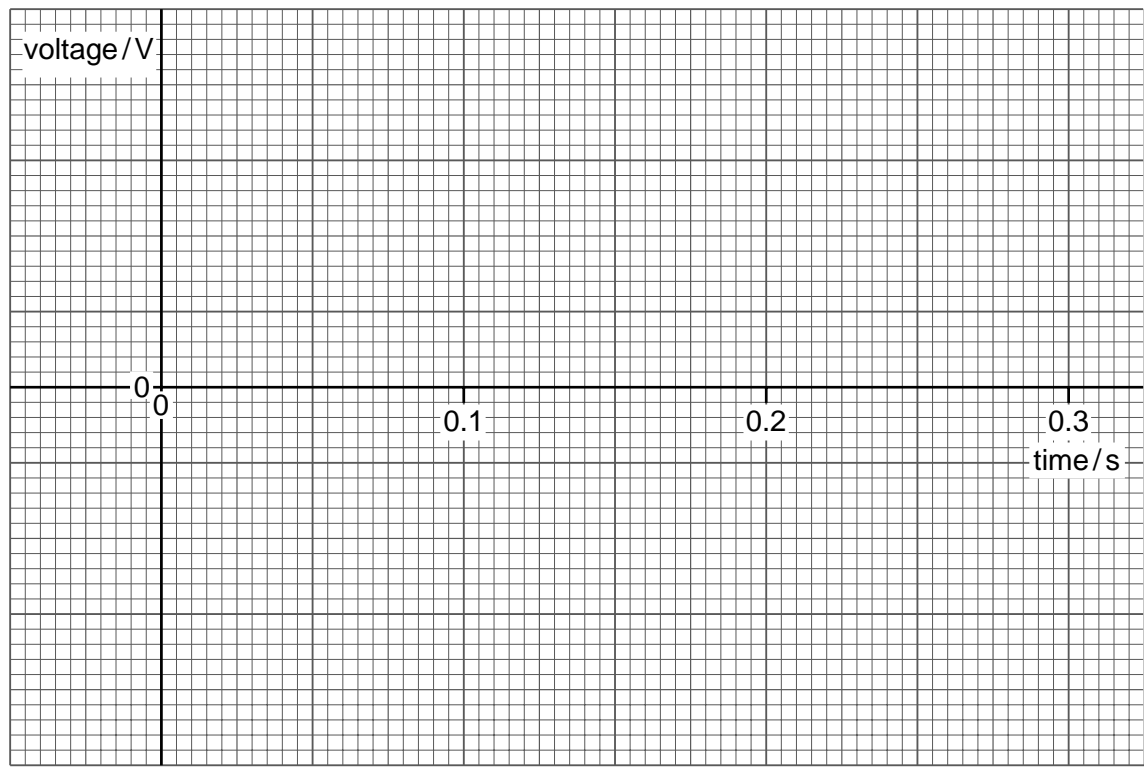

Fig. 8.2

- On Fig. 8.2,
- (i) mark suitable voltage values on the voltage axis,
 - (ii) draw a graph of the generator output.

(b) The generator shown in Fig. 8.1 works by electromagnetic induction.

Explain how this effect produces the output voltage.

.....
.....
.....
..... [3]

(c) State the energy changes that occur in the generator when it is producing output.

..... [2]

- 9 (a) Fig. 9.1 shows the screen of a c.r.o. (cathode-ray oscilloscope).
The c.r.o. is being used to display the output from a microphone.
The vertical scale on the screen is in volts.

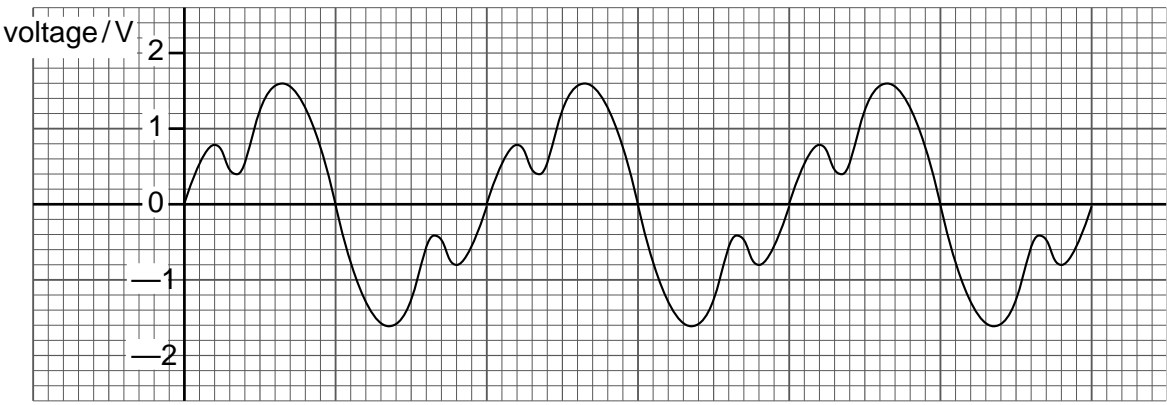

Fig. 9.1

- (i) Describe the output from the microphone.
-
-
- (ii) Use the graph to determine the peak voltage of the output.
-
- (iii) Describe how you could check that the voltage calibration on the screen is correct.
-
-

[4]

(b) Fig. 9.2 shows the screen of the c.r.o. when it is being used to measure a small interval between two voltage pulses.

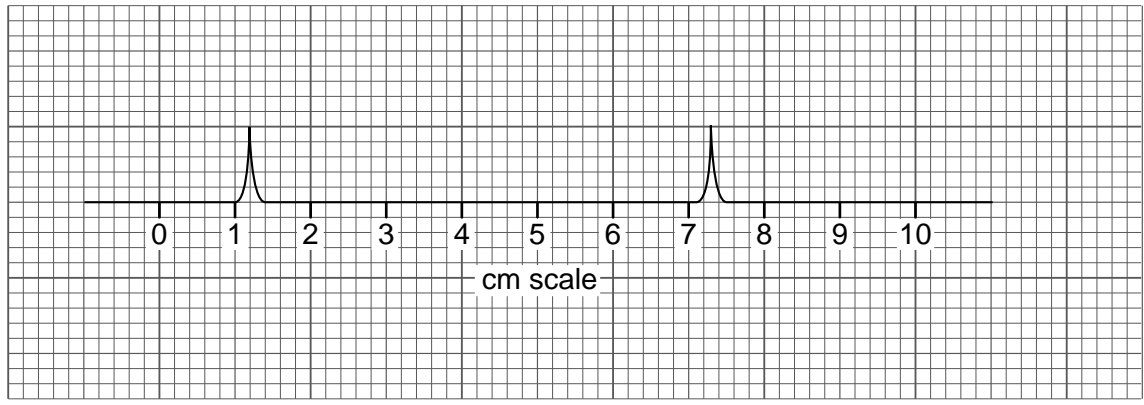

Fig. 9.2

(i) What is the distance on the screen between the two voltage pulses?

.....

(ii) The time-base control of the c.r.o. is set at 5.0 ms/cm.

Calculate the time interval between the voltage pulses.

time =

(iii) Suggest **one** example where a c.r.o. can be used to measure a small time interval.

.....

[4]

10 Fig. 10.1 shows a battery with an e.m.f of 12 V supplying power to two lamps.
The total power supplied is 150 W when both lamps are on.

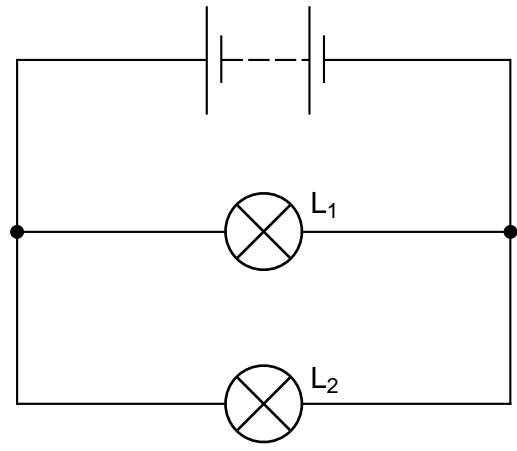

Fig. 10.1

(a) Calculate the current supplied by the battery when both lamps are on.

current = [2]

(b) The current in lamp L_2 is 5.0 A.

Calculate

(i) the current in lamp L_1 ,

current =

(ii) the power of lamp L_1 ,

power =

(iii) the resistance of lamp L_1 .

resistance =

11 (a) A sodium nucleus decays by the emission of a β -particle to form magnesium.

(i) Complete the decay equation below.

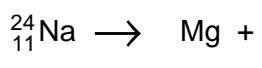

(ii) Fig. 11.1 shows β -particles from sodium nuclei moving into the space between the poles of a magnet.

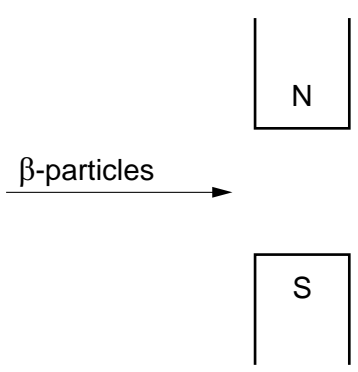

Fig. 11.1

Describe the path of the β -particles between the magnetic poles.

.....

.....

.....

[5]

(b) Very small quantities of a radioactive isotope are used to check the circulation of blood by injecting the isotope into the bloodstream.

(i) Describe how the results are obtained.

.....

.....

.....

.....

(ii) Explain why a γ -emitting isotope is used for this purpose rather than one that emits either α -particles or β -particles.

.....

.....

.....

[4]

