



**Cambridge International Examinations**  
Cambridge International General Certificate of Secondary Education

---

**PHYSICS****0625/12**

Paper 1 Multiple Choice (Core)

**October/November 2018****45 minutes**

Additional Materials:      Multiple Choice Answer Sheet  
   Soft clean eraser  
   Soft pencil (type B or HB recommended)

\* 0 3 0 0 2 5 0 6 8 6 \*



---

**READ THESE INSTRUCTIONS FIRST**

Write in soft pencil.

Do not use staples, paper clips, glue or correction fluid.

Write your name, Centre number and candidate number on the Answer Sheet in the spaces provided unless this has been done for you.

**DO NOT WRITE IN ANY BARCODES.**There are **forty** questions on this paper. Answer **all** questions. For each question there are four possible answers **A, B, C** and **D**.Choose the **one** you consider correct and record your choice in **soft pencil** on the separate Answer Sheet.**Read the instructions on the Answer Sheet very carefully.**

Each correct answer will score one mark. A mark will not be deducted for a wrong answer.

Any rough working should be done in this booklet.

Electronic calculators may be used.

Take the weight of 1.0 kg to be 10 N (acceleration of free fall =  $10 \text{ m/s}^2$ ).

---

The syllabus is approved for use in England, Wales and Northern Ireland as a Cambridge International Level 1/Level 2 Certificate.

This document consists of **16** printed pages.

- 1 A pendulum is set in motion and timed. The time measured for 20 complete swings is 30 s.  
What is the time for one complete swing of the pendulum?

A 0.67 s      B 0.75 s      C 1.5 s      D 3.0 s

- 2 The graph shows how the speed of an object varies with time.

At which point on the graph is the greatest distance travelled per second?

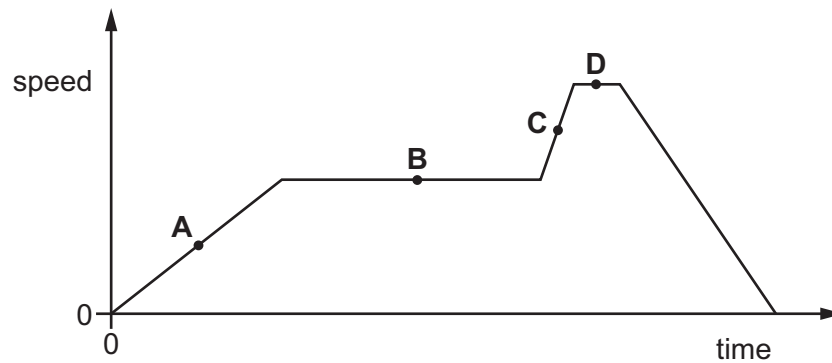

- 3 An athlete runs at a speed of 8 m/s for 10 s, and then at a speed of 6 m/s for 12 s.

Which calculation gives the average speed of the athlete in m/s?

A  $\frac{8+6}{2}$

B  $\frac{(8 \times 10) + (6 \times 12)}{22}$

C  $\frac{(8 \div 10) + (6 \div 12)}{22}$

D  $\frac{(10 \div 8) + (12 \div 6)}{22}$

- 4 Which quantity is measured in newtons?

A energy

B mass

C weight

D work

- 5 An object is suspended from a spring balance on the Earth. The same object is suspended from the same spring balance on another planet.

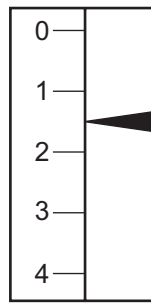

reading on  
Earth

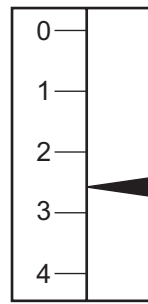

reading on  
another planet

Which statement explains the difference between the two readings?

- A** Both the mass and the weight of the object are greater on the other planet.
- B** The mass of the object is greater on the other planet than on Earth, but the weight is unchanged.
- C** The spring stretches more easily when on the other planet.
- D** The weight of the object is greater on the other planet than on Earth, but the mass is unchanged.
- 6 The diagram shows four blocks of different metals. Each block has a mass of 12g.

Which metal has the largest density?

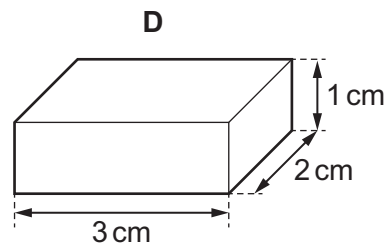
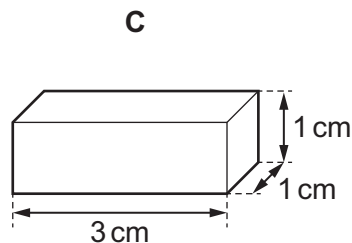
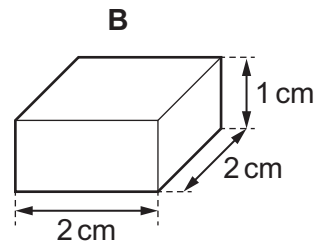
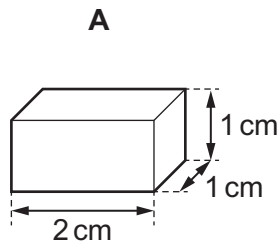

7 Which is an example of a force?

- A density
- B mass
- C volume
- D weight

8 A car moves along a level road.

The diagram shows all of the horizontal forces acting on the car.

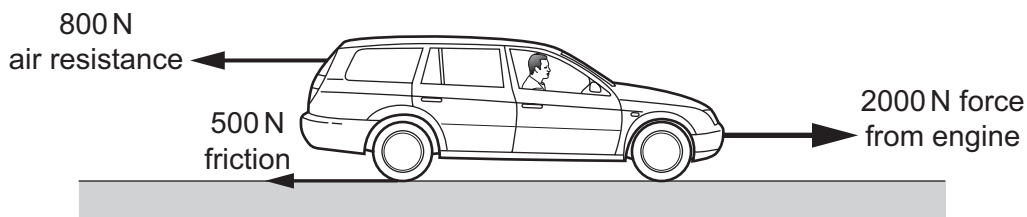

Which statement is correct?

- A The car is slowing down.
  - B The car is speeding up.
  - C The car is moving at a constant speed.
  - D The car is moving backwards.
- 9 Point X is the centre of mass of a lamina in the shape of a triangle with sides of equal length. The top of the triangle is cut off along the dotted line shown.

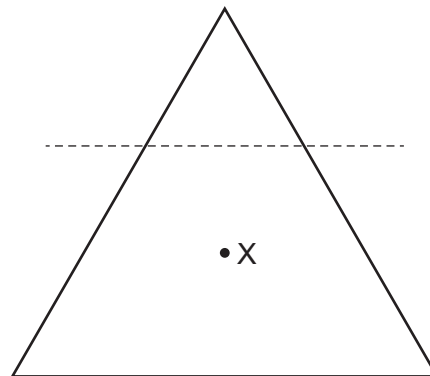

What happens to the centre of mass, X?

- A moves towards the bottom of the page
- B moves to the left
- C moves to the right
- D moves towards the top of the page

- 10 Which device is designed to convert chemical energy into kinetic energy?
- A an a.c. generator
  - B a battery-powered torch
  - C a car engine
  - D a wind-up mechanical clock
- 11 Which two physical quantities must be used to calculate the power developed by a student running up a flight of steps?
- A force exerted and the vertical height of the steps only
  - B force exerted and the time taken only
  - C work done and the vertical height of the steps only
  - D work done and the time taken only
- 12 A simple mercury barometer is used to measure the atmospheric pressure.

Which height is measured to find the atmospheric pressure?

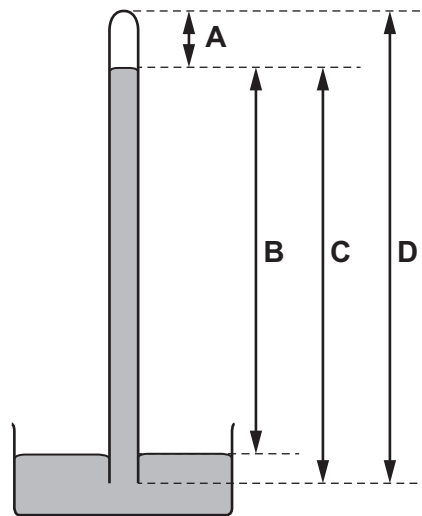

- 13 The particles of a gas, in a container of fixed volume, are given more energy.
- Which effect does this have on the gas?
- A Both the pressure and temperature of the gas increase.
  - B Only the temperature of the gas increases.
  - C Neither the pressure nor temperature of the gas increases.
  - D Only the pressure of the gas increases.

14 A manometer is used to measure the pressure of a gas supply.

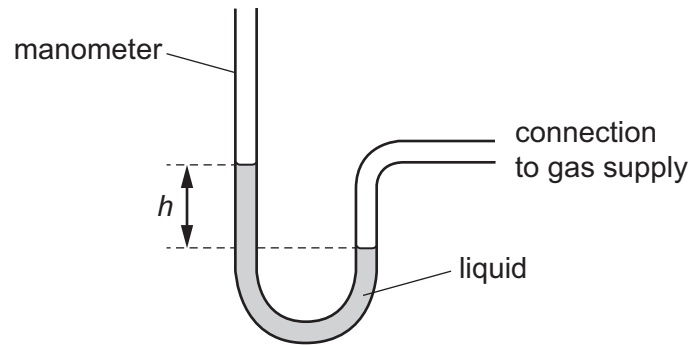

Which change gives a greater value of height  $h$ ?

- A using a less dense liquid
  - B using a more dense liquid
  - C using a narrower tube
  - D using a wider tube
- 15 Diagram 1 shows apparatus being used to observe smoke particles.

Diagram 2 shows how a smoke particle moves randomly.

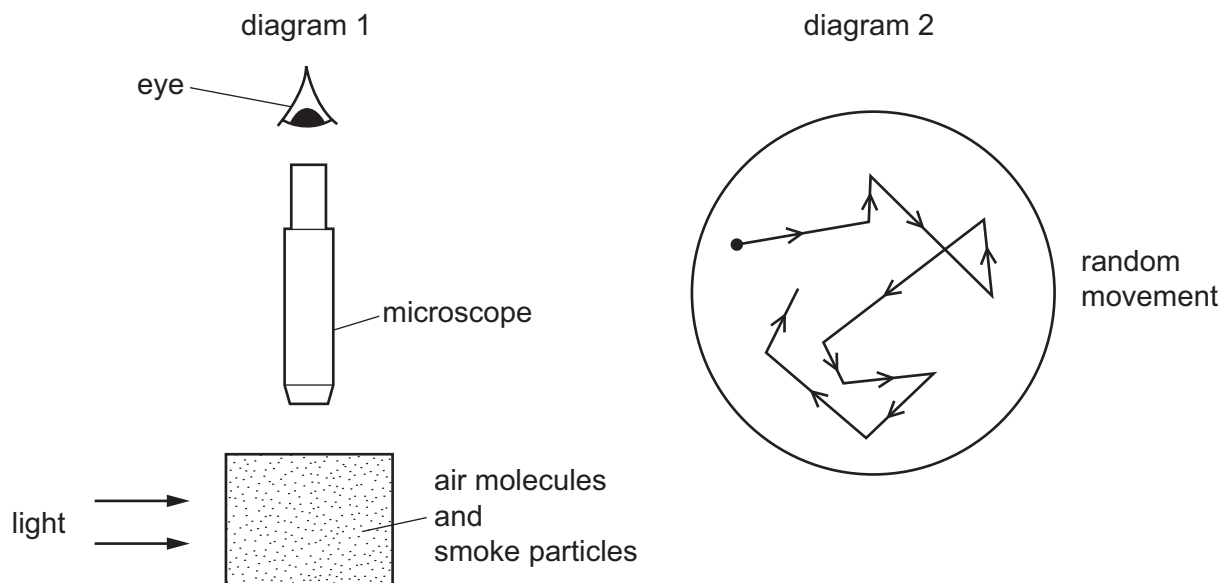

Why do the smoke particles move randomly?

- A They are hit by air molecules.
- B They are less dense than air.
- C They are moved by convection currents.
- D They gain energy from the light.

- 16 The metal lid on a glass jar is difficult to unscrew.

The jar is placed in a warm oven until the jar and the lid reach the same temperature. The lid is now easily unscrewed.

Which property accounts for this?

- A thermal capacity of the jar  
 B thermal capacity of the lid  
 C thermal conduction  
 D thermal expansion
- 17 Two cold metal containers X and Y are both filled with the same mass of hot water at the same temperature.

Both containers are well insulated.

The thermal capacity of container X is greater than that of container Y.

How do the final temperatures of the water in X and in Y compare?

- A The temperature in X is higher than in Y.  
 B The temperature in X is lower than in Y.  
 C The temperatures in X and in Y are equal but lower than the initial temperature of the water.  
 D The temperatures in X and in Y are the same as the initial temperature of the water.
- 18 Some of the Sun's radiation passes through a prism. The diagram shows the spectrum of the radiation.

Which point on the screen does the infra-red radiation reach?

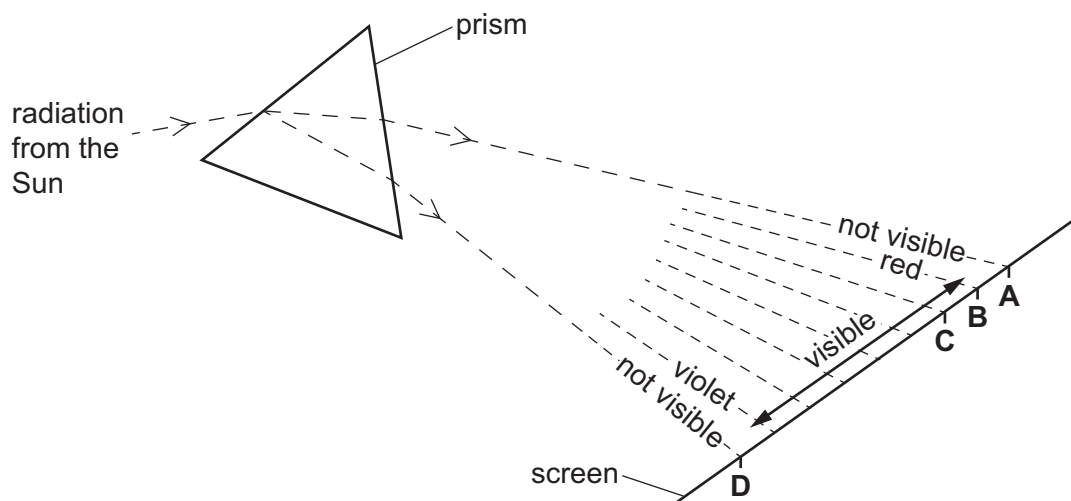

19 Which statement about convection is **not** correct?

- A It enables water in a pan on a cooker to get evenly heated.
- B It happens in liquids and gases.
- C It means that heat rises.
- D It occurs because the density of a fluid decreases when it is heated.

20 What is meant by the frequency of a water wave?

- A the distance between consecutive crests of the wave
- B the distance moved by the wave per unit time
- C the maximum vertical displacement of the wave
- D the number of crests passing a point per unit time

21 Plane water waves travel from a shallow region into a deeper region. They travel more quickly in the deeper water.

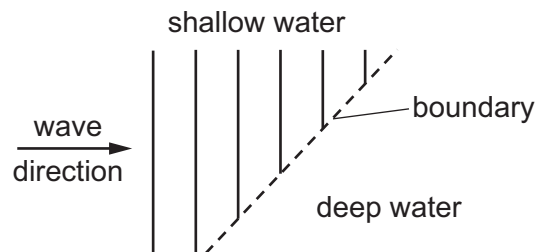

Which diagram shows the wave pattern in the deeper water?

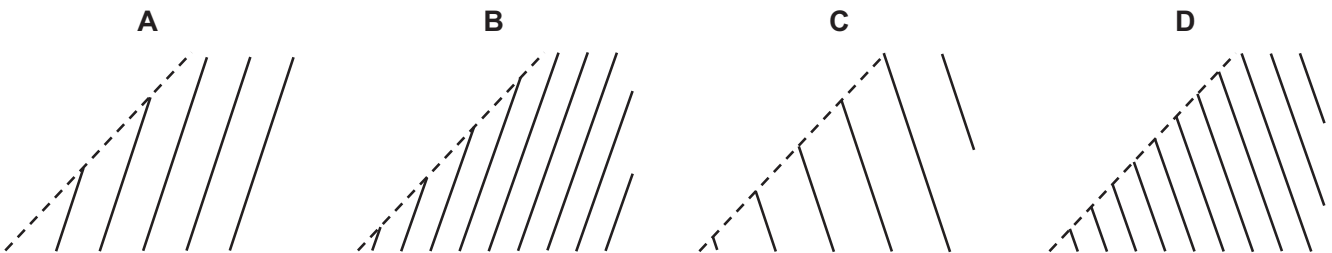



- 22 The diagram shows two plane mirrors at  $90^\circ$  to each other. A ray of light is incident on one of the mirrors. The ray reflects off both mirrors before reaching a screen.

At which labelled point does the ray reach the screen?

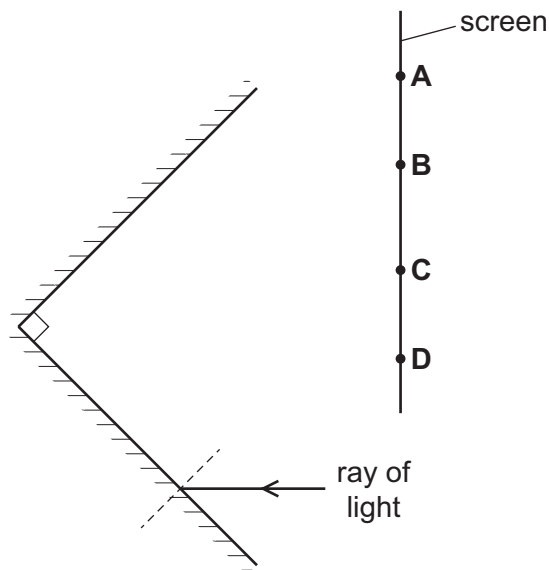

- 23 Which diagram shows the formation of a real image of an object O placed in front of a converging lens?

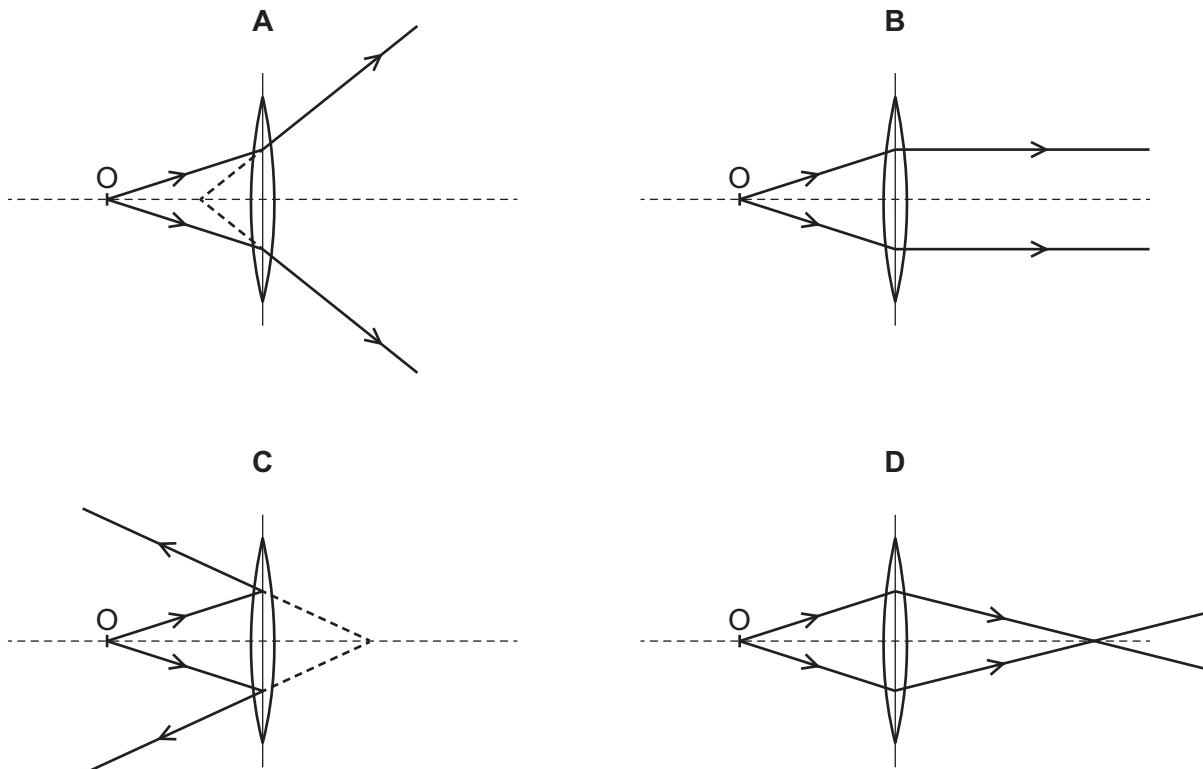

- 24** Different parts of the electromagnetic spectrum are used for different purposes. Below are four statements about parts of the spectrum.

statement 1: Infra-red waves are used in television remote controllers.

statement 2: Radio waves are used to transmit television pictures from satellites to Earth.

statement 3: Ultraviolet waves are used for intruder alarms.

statement 4: X-rays are used for security checks.

Which statements are correct?

- A** 1 and 2      **B** 1 and 4      **C** 2 and 3      **D** 3 and 4
- 25** Which statement about ultrasound is correct?
- A** Ultrasound must have greater amplitude than audible sound.
- B** Ultrasound must have greater frequency than audible sound.
- C** Ultrasound must have lower amplitude than audible sound.
- D** Ultrasound must have lower frequency than audible sound.
- 26** An iron bar PQ is placed close to a bar magnet.

In which diagram does end P become an induced north pole?

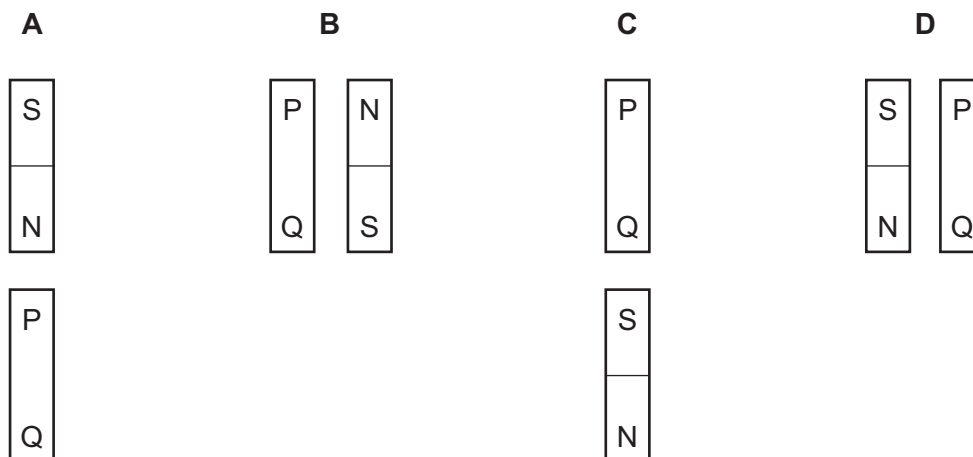

- 27 The diagram shows a bar magnet at rest on a smooth horizontal surface. A length of soft-iron wire is held parallel to the magnet.

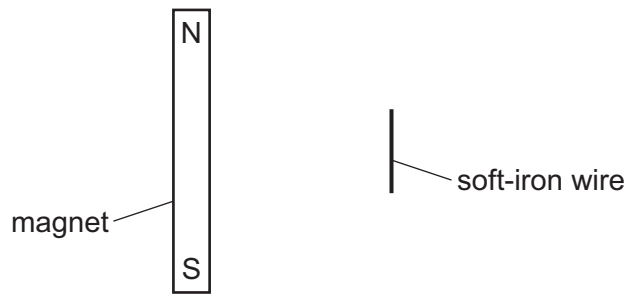

The wire is released.

What happens?

- A** The wire moves away from the magnet.
- B** The wire moves towards the magnet.
- C** The wire's centre stays in its present position and the wire rotates through  $90^\circ$  in a clockwise direction.
- D** The wire's centre stays in its present position and the wire rotates through  $90^\circ$  in an anticlockwise direction.
- 28 A negatively charged plastic rod P is placed above a positively charged plastic rod Q.

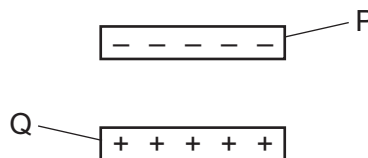

What are the directions of the electrostatic forces on rod P and on rod Q?

	electrostatic force on rod P	electrostatic force on rod Q
<b>A</b>	downwards	downwards
<b>B</b>	downwards	upwards
<b>C</b>	upwards	downwards
<b>D</b>	upwards	upwards

- 29 The diagrams show the readings on an ammeter in a series circuit before and after the switch in the circuit has been closed.

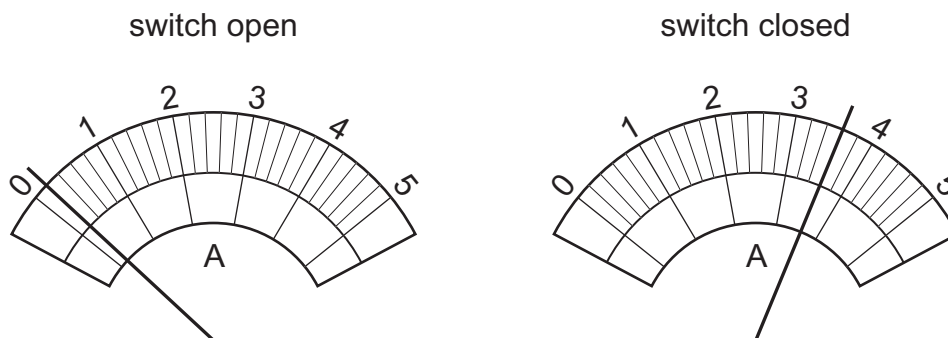

What is the current in the circuit when the switch is closed?

- A** 3.2A                      **B** 3.4A                      **C** 3.6A                      **D** 3.8A
- 30 A student investigates the resistance of a lamp.

Which row states how the meters must be connected?

	ammeter	voltmeter
<b>A</b>	in parallel with the lamp	in parallel with the lamp
<b>B</b>	in parallel with the lamp	in series with the lamp
<b>C</b>	in series with the lamp	in parallel with the lamp
<b>D</b>	in series with the lamp	in series with the lamp

- 31 A lamp is connected into a circuit so that the potential difference across it can be varied from 0 to 12V.

Which circuit is suitable?

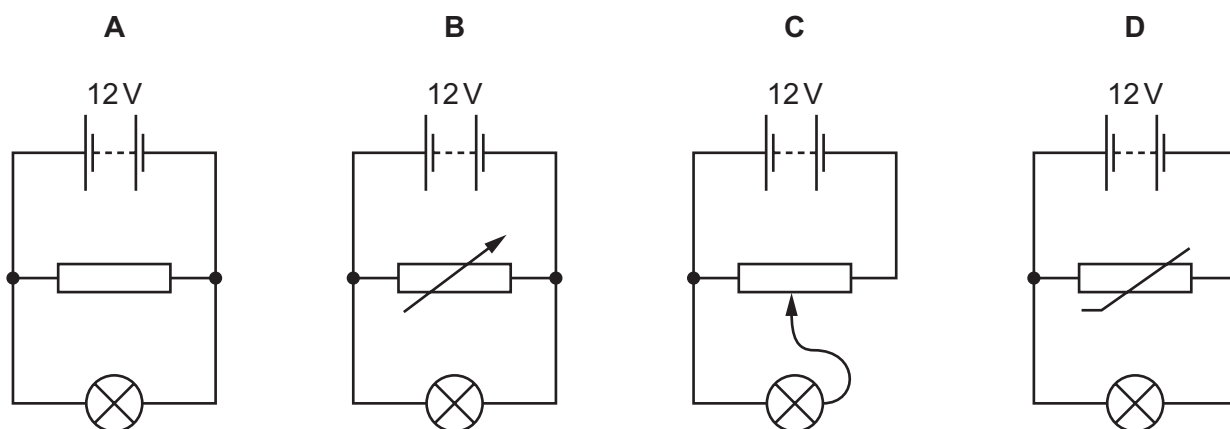

32 The diagram shows a circuit.

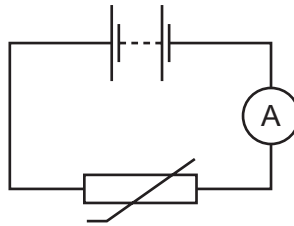

Which statement describes and explains how the circuit behaves?

- A The ammeter reading decreases when the light intensity decreases.
  - B The ammeter reading decreases when the temperature decreases.
  - C The ammeter reading increases when the light intensity decreases.
  - D The ammeter reading increases when the temperature decreases.
- 33 Which component uses a small direct current (d.c.) in one circuit to switch on a much larger current in a second circuit?
- A potential divider
  - B relay
  - C transformer
  - D variable resistor

- 34 Either a fuse or a circuit-breaker can be used to protect electrical cables from large currents that could cause overheating.

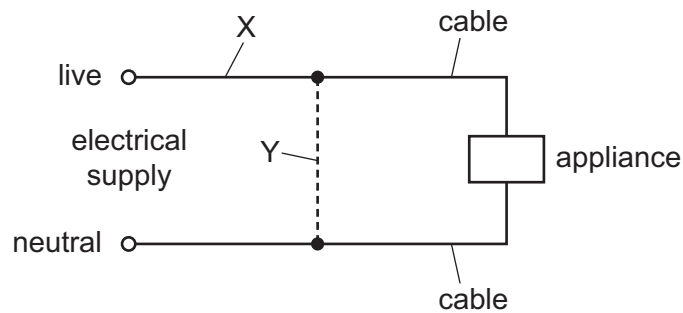

When a fuse is used, where should it be connected, and when a circuit-breaker is used, where should it be connected?

	position of fuse	position of circuit-breaker
<b>A</b>	X	X
<b>B</b>	X	Y
<b>C</b>	Y	X
<b>D</b>	Y	Y

- 35 The diagram shows a horizontal wire between the two magnetic poles of a U-shaped magnet. The U-shaped magnet is on a balance.

When the switch closed, the reading on the balance decreases.

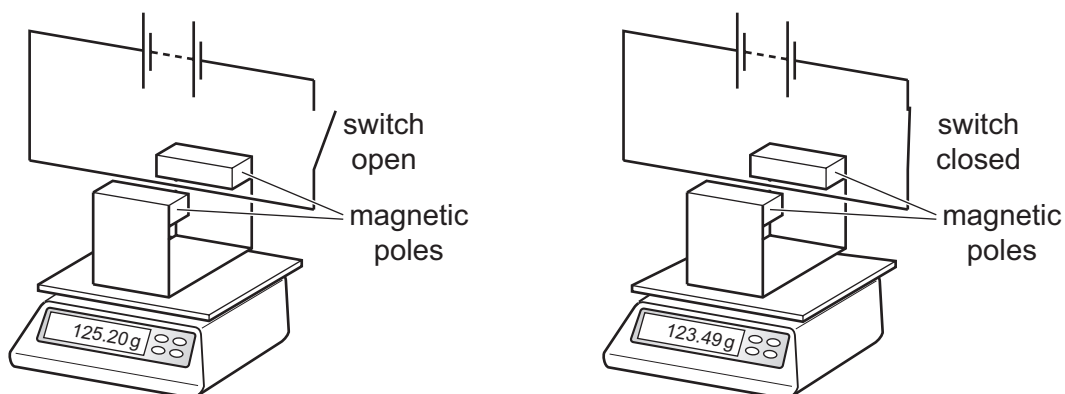

The experiment is carried out three more times with the following changes made.

- 1 Only the current is reversed.
- 2 Only the magnetic field is reversed.
- 3 Both the current and the magnetic field are reversed at the same time.

Which changes cause an increase in the reading on the balance?

- A** 1 only      **B** 2 only      **C** 3 only      **D** 1 and 2 only

36 The diagram shows a coil of wire between the poles of a magnet.

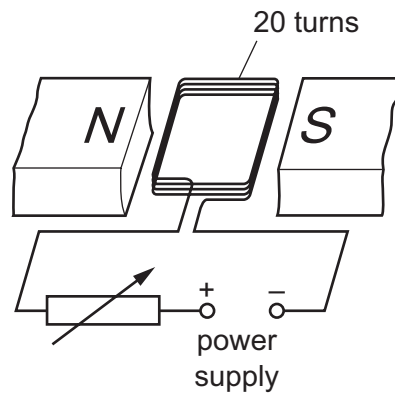

The coil consists of 20 turns of insulated wire.

The coil is connected to a variable resistor and a power supply.

How can the turning effect on the coil be increased?

- A by moving the poles of the magnet closer to the coil
- B by reducing the number of turns on the coil while keeping the current constant
- C by increasing the resistance of the variable resistor
- D by reversing the terminals of the power supply

37 Which diagram represents the structure of a neutral atom?

**A**

**B**

**C**

**D**

key

○ neutron

⊕ proton

⊖ electron

38 The nuclide notation for the isotope lithium-7 is  ${}^7_3\text{Li}$ .

How many neutrons are there in an atom of lithium-7?

- A 3
- B 4
- C 7
- D 10

39 The diagram shows the paths of three different types of radiation X, Y and Z.

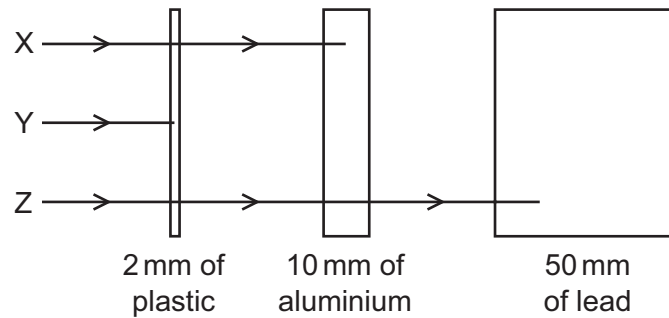

Which row correctly identifies X, Y and Z?

	X	Y	Z
<b>A</b>	$\alpha$ -particles	$\beta$ -particles	$\gamma$ -rays
<b>B</b>	$\beta$ -particles	$\alpha$ -particles	$\gamma$ -rays
<b>C</b>	$\beta$ -particles	$\gamma$ -rays	$\alpha$ -particles
<b>D</b>	$\gamma$ -rays	$\alpha$ -particles	$\beta$ -particles

40 Samples of four different radioactive isotopes all emit radiation at the same rate.

As time passes, the rates of emission decrease for all the samples.

Which sample of isotope has the greatest decrease in rate?

	isotope	half-life
<b>A</b>	americium-241	470 years
<b>B</b>	iodine-128	25 minutes
<b>C</b>	thoron-220	54.5 seconds
<b>D</b>	uranium-237	6.75 days

Permission to reproduce items where third-party owned material protected by copyright is included has been sought and cleared where possible. Every reasonable effort has been made by the publisher (UCLES) to trace copyright holders, but if any items requiring clearance have unwittingly been included, the publisher will be pleased to make amends at the earliest possible opportunity.

To avoid the issue of disclosure of answer-related information to candidates, all copyright acknowledgements are reproduced online in the Cambridge International Examinations Copyright Acknowledgements Booklet. This is produced for each series of examinations and is freely available to download at [www.cie.org.uk](http://www.cie.org.uk) after the live examination series.

Cambridge International Examinations is part of the Cambridge Assessment Group. Cambridge Assessment is the brand name of University of Cambridge Local Examinations Syndicate (UCLES), which is itself a department of the University of Cambridge.