



Cambridge IGCSE™

CANDIDATE
NAME

CENTRE
NUMBER

--	--	--	--	--

CANDIDATE
NUMBER

--	--	--	--

CO-ORDINATED SCIENCES

0654/61

Paper 6 Alternative to Practical

October/November 2020

1 hour 30 minutes

You must answer on the question paper.

No additional materials are needed.

INSTRUCTIONS

- Answer **all** questions.
- Use a black or dark blue pen. You may use an HB pencil for any diagrams or graphs.
- Write your name, centre number and candidate number in the boxes at the top of the page.
- Write your answer to each question in the space provided.
- Do **not** use an erasable pen or correction fluid.
- Do **not** write on any bar codes.
- You may use a calculator.
- You should show all your working and use appropriate units.

INFORMATION

- The total mark for this paper is 60.
- The number of marks for each question or part question is shown in brackets [].

This document has **16** pages. Blank pages are indicated.

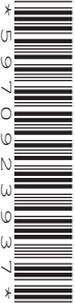

- 1 A student wants to estimate the concentration of reducing sugar in a sample of food **U**.

The student does this by comparing sample **U** with glucose solutions of known concentrations.

(a) Procedure

The student:

- labels four test-tubes **A**, **B**, **C** and **D**
- pours some testing solution **G** into each of the four test-tubes
- adds glucose solution of different concentrations to test-tubes **A**, **B**, **C** and **D**, as shown in Table 1.1
- places the test-tubes in a water-bath for three minutes.

The student records in Table 1.1 the final colour in each test-tube.

Table 1.1

test-tube	percentage concentration of glucose solution	final colour observed
A	0.0	blue
B	0.5	green
C	1.0	orange
D	2.0	red

- (i) The student uses the same procedure to test food sample **U** and concludes it has a glucose concentration of 1.5%.

Use Table 1.1 to suggest the final colour the student observes in test-tube **U**.

..... [1]

- (ii) Explain why it is difficult for the student to determine an accurate value for the glucose concentration of **U**.

.....
 [1]

- (b) Suggest a piece of apparatus suitable for measuring 2 cm³ of glucose solution.

..... [1]

- (c) Suggest a suitable temperature for the water-bath used in (a).

..... [1]

- (d) Name the test solution **G** and state its initial colour.

test solution

initial colour

[2]

- (e) State and explain a safety precaution the student takes when doing this investigation.

precaution

explanation

[1]

- (f) Another student makes mistakes when doing the procedure in (a).

Their results are shown in Table 1.2.

Table 1.2

test-tube	percentage concentration of glucose solution	final colour observed
A	0.0	blue
B	0.5	red
C	1.0	red
D	2.0	blue

Suggest **two** different mistakes which would give these results.

mistake 1

.....

mistake 2

.....

[2]

- (g) (i) Name the **two** substances used to test a food sample for the presence of fat.

..... and [1]

- (ii) State the observation for a positive result.

..... [1]

- (iii) Explain why there should be no flames in the laboratory when doing this test.

..... [1]

- (iv) Explain why this test is **not** used to estimate the concentration of fat in a food sample.

.....

..... [1]

[Total: 13]

3 A student is provided with solid **J** which is a mixture of **two** compounds.

Solid **J** contains one anion and two cations.

One compound is soluble and the other is insoluble in water.

The student does a series of experiments to investigate **J**.

(a) The student:

- places some of solid **J** into a test-tube
- adds dilute hydrochloric acid to the test-tube
- identifies the gas produced as carbon dioxide.

(i) State the test used to identify carbon dioxide and give the observation for a positive result.

test

observation

[1]

(ii) Use the result in (a) to identify the anion present in **J**.

..... [1]

(b) The student:

- places some of solid **J** into a boiling tube
- adds some aqueous sodium hydroxide into the boiling tube
- carefully warms the mixture
- identifies the gas produced as ammonia.

(i) State the test used to identify ammonia and give the observation for a positive result.

test

observation

[2]

(ii) Use the result in (b) to identify a cation present in **J**.

..... [1]

(iii) State and explain **one** safety precaution the student takes during this experiment.

safety precaution

explanation

.....

[1]

(c) The student:

- places some of solid **J** into a beaker
- adds some distilled water to **J** and stirs for one minute
- filters the mixture and keeps the residue in the filter paper
- washes the residue with distilled water
- places a small sample of the residue into a test-tube
- adds some dilute hydrochloric acid into this test-tube
- stirs the mixture to make a solution.

(i) The student adds aqueous ammonia drop by drop until it is in excess.

A white precipitate is formed that is soluble in excess aqueous ammonia.

Identify the other cation shown to be present in **J**.

..... [1]

(ii) Suggest why it is important that the student washes the residue with distilled water.

.....

..... [1]

(iii) Draw a labelled diagram of the assembled apparatus used to filter the mixture.

[1]

[Total: 9]

- 4 A student investigates the effect of increasing the length of magnesium ribbon on the temperature rise in the reaction between magnesium and dilute hydrochloric acid.

The student:

- cuts a 10 mm length of magnesium ribbon
- measures 25 cm³ of dilute hydrochloric acid and pours it into a beaker
- measures and records in Table 4.1 the temperature of the dilute hydrochloric acid
- adds the magnesium ribbon into the acid and keeps it under the surface of the acid using the thermometer
- measures and records in Table 4.1 the highest temperature of the reaction mixture to the nearest 0.5 °C.

The student repeats the procedure using the different lengths of magnesium ribbon shown in Table 4.1.

- (a) The student's results are recorded in Table 4.1.

Table 4.1

length of magnesium ribbon /mm	temperature of acid at start /°C	highest temperature of the reaction mixture /°C	temperature rise of the solution /°C
10	20.0	22.0	2.0
20	20.5	24.5	4.0
30	20.0		
40	20.0		
50	20.5		

Fig. 4.1 shows the thermometer readings for the highest temperature of the reaction mixture reached for 30 mm, 40 mm and 50 mm lengths of magnesium added.

Record in Table 4.1 these temperatures to the nearest 0.5 °C.

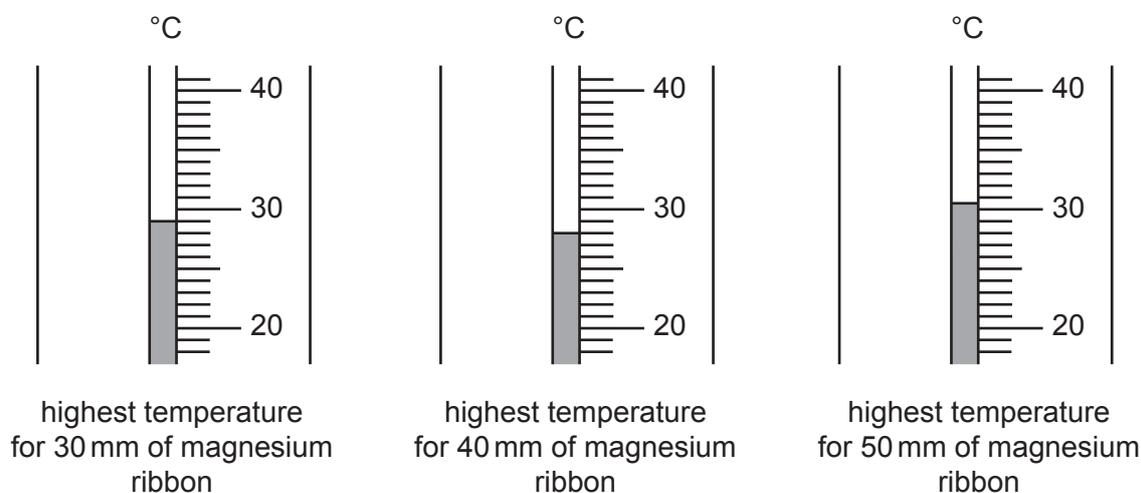

Fig. 4.1

[3]

- (b) Calculate the temperature rise of the reaction for each experiment.

Record your answers in Table 4.1.

[1]

- (c) (i) Suggest which one of the results is anomalous.

Explain your answer.

anomalous result

explanation

[1]

- (ii) Suggest what the student can do to check if the result identified in (c)(i) is anomalous.

.....

..... [1]

- (d) State the relationship between the length of magnesium ribbon and the temperature rise of the reaction.

.....

..... [1]

- (e) State **two** variables that must be controlled in this investigation.

variable 1

variable 2

[2]

- (f) A teacher says that the highest temperature measured in each experiment is lower than expected.

- (i) Suggest **one** reason why the highest temperature measured is lower than expected.

.....

..... [1]

- (ii) Suggest **one** improvement to the investigation which will make the highest temperature measured closer to the expected value.

.....

..... [1]

[Total: 11]

5 A student uses two different methods to measure the spring constant k of a spring.

The spring constant k of a spring is a measure of the stiffness of the spring.

(a) **Method 1**

- She measures the unstretched length of the spring.

Fig. 5.1 shows a full-scale diagram of the unstretched spring.

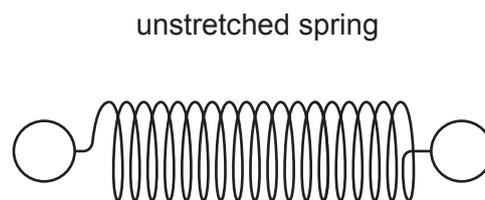

Fig. 5.1

Measure the unstretched length l_0 of the spring to the nearest 0.1 cm.

Do **not** include the loops at the end of the spring in your measurement.

$l_0 = \dots\dots\dots$ cm [1]

- (b)
- She attaches the spring to a clamp.
 - She suspends a 200 g mass on the spring as shown in Fig. 5.2.

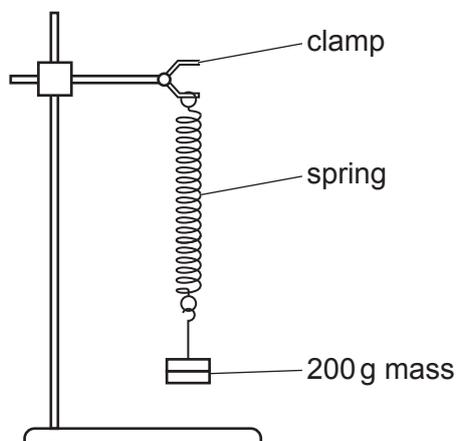

Fig. 5.2 (not to scale)

Fig. 5.3 shows a full-scale diagram of the stretched spring.

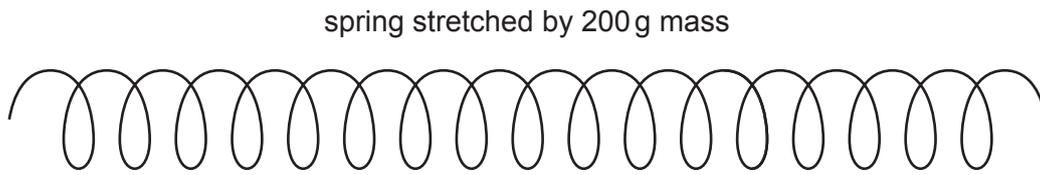

Fig. 5.3

Measure the new length l_1 of the spring to the nearest 0.1 cm.

$$l_1 = \dots\dots\dots \text{ cm}$$

Calculate the extension e of the spring produced by the mass. Use the equation shown.

$$e = l_1 - l_0$$

$$e = \dots\dots\dots \text{ cm [1]}$$

(c) Calculate the spring constant k of the spring. Use the equation shown.

$$k = \frac{2}{e}$$

$$k = \dots\dots\dots \text{ N/cm [1]}$$

(d) **Method 2**

- She pulls the mass down a small distance and releases it.

The mass oscillates up and down.

The period T of the oscillations is the time taken for **one** oscillation.

- She measures the time t taken for 20 oscillations.
- She records this time in Table 5.1.

Fig. 5.4 shows the reading of the stop-watch.



Fig. 5.4

Record the time t for 20 oscillations in Table 5.1 to one decimal place. [1]

Table 5.1

mass m /g	time t for 20 oscillations /s	period T /s	T^2 /s ²
200			

(e) (i) Calculate the period T , the time for **one** oscillation.

Record your answer in Table 5.1. [1]

(ii) Calculate the value of T^2 .

Record your answer in Table 5.1. [1]

(f) Use the results in Table 5.1 to calculate the spring constant k of the spring.

Use the equation shown.

$$k = \frac{0.08}{T^2}$$

$k = \dots\dots\dots$ N/cm [1]

(g) Compare your values of k from (c) and (f). State whether they agree within the limits of experimental error.

Explain your answer.

.....
 [1]

(h) It is important to avoid line-of-sight (parallax) errors when measuring the length of the spring.

Describe how the student avoids this error.

.....
 [1]

(i) Explain why timing 20 oscillations gives a more accurate value for the period T than timing a smaller number of oscillations.

.....
 [1]

[Total: 10]

6 A student investigates the cooling of hot water in a beaker.

The student:

- pours 200 cm^3 of hot water into a beaker
- measures the temperature θ of the hot water when the reading on the thermometer stops rising.

(a) Fig. 6.1 shows part of a thermometer scale.

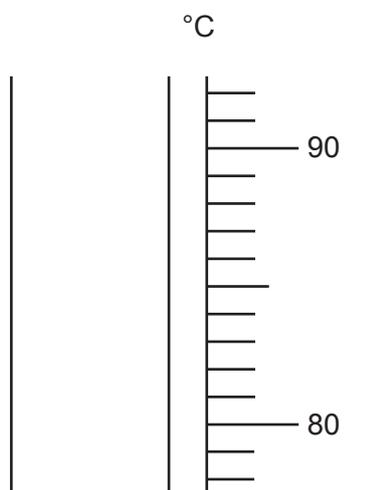

Fig. 6.1

Use the information in Table 6.1 to draw a line on Fig. 6.1 to show the level of the liquid in the thermometer at time $t = 0$. [1]

Table 6.1

time t /	temperature θ /
0	85.5
60	79.0
120	74.0
180	71.5
240	69.0
300	68.0

(b) The student:

- starts the stop-watch
- records in Table 6.1 the temperature θ of the water and the time t every 60 s for 300 s.

Add units to the headings in Table 6.1.

[1]

- (c) (i) On the grid provided, plot a graph of temperature θ (vertical axis) against time t .

The vertical axis starts from $\theta = 60$.

[3]

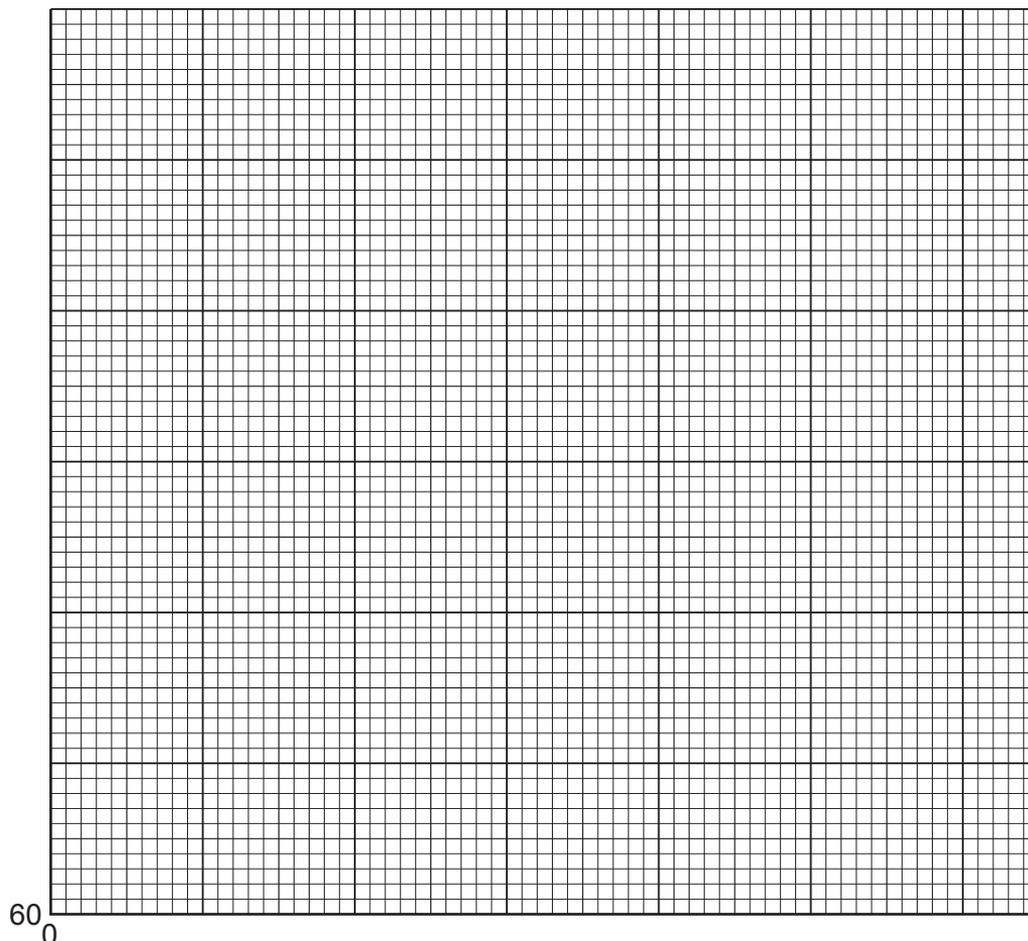

- (ii) Draw the best-fit curve. [1]
- (d) Mark with a letter **M** on your graph to show where the rate of cooling is greatest. [1]
- (e) Calculate the average rate of cooling of the hot water during the whole investigation. Use the equation shown.

$$\text{average rate of cooling} = \frac{\text{total temperature decrease}}{\text{time taken}}$$

average rate of cooling = °C/s [1]

(f) (i) State **one** safety precaution taken during the investigation.

Explain your answer.

safety precaution

explanation

[1]

(ii) Suggest **one** change that the student can make to the investigation to reduce the rate of cooling of the hot water.

.....

..... [1]

[Total: 10]

BLANK PAGE

Permission to reproduce items where third-party owned material protected by copyright is included has been sought and cleared where possible. Every reasonable effort has been made by the publisher (UCLES) to trace copyright holders, but if any items requiring clearance have unwittingly been included, the publisher will be pleased to make amends at the earliest possible opportunity.

To avoid the issue of disclosure of answer-related information to candidates, all copyright acknowledgements are reproduced online in the Cambridge Assessment International Education Copyright Acknowledgements Booklet. This is produced for each series of examinations and is freely available to download at www.cambridgeinternational.org after the live examination series.

Cambridge Assessment International Education is part of the Cambridge Assessment Group. Cambridge Assessment is the brand name of the University of Cambridge Local Examinations Syndicate (UCLES), which itself is a department of the University of Cambridge.