



Cambridge International AS & A Level

PHYSICS

9702/12

Paper 1 Multiple Choice

October/November 2022

1 hour 15 minutes

You must answer on the multiple choice answer sheet.

You will need: Multiple choice answer sheet
Soft clean eraser
Soft pencil (type B or HB is recommended)

INSTRUCTIONS

- There are **forty** questions on this paper. Answer **all** questions.
- For each question there are four possible answers **A, B, C** and **D**. Choose the **one** you consider correct and record your choice in soft pencil on the multiple choice answer sheet.
- Follow the instructions on the multiple choice answer sheet.
- Write in soft pencil.
- Write your name, centre number and candidate number on the multiple choice answer sheet in the spaces provided unless this has been done for you.
- Do **not** use correction fluid.
- Do **not** write on any bar codes.
- You may use a calculator.

INFORMATION

- The total mark for this paper is 40.
- Each correct answer will score one mark.
- Any rough working should be done on this question paper.

This document has **16** pages.



Data

acceleration of free fall	$g = 9.81 \text{ m s}^{-2}$
speed of light in free space	$c = 3.00 \times 10^8 \text{ m s}^{-1}$
elementary charge	$e = 1.60 \times 10^{-19} \text{ C}$
unified atomic mass unit	$1 \text{ u} = 1.66 \times 10^{-27} \text{ kg}$
rest mass of proton	$m_p = 1.67 \times 10^{-27} \text{ kg}$
rest mass of electron	$m_e = 9.11 \times 10^{-31} \text{ kg}$
Avogadro constant	$N_A = 6.02 \times 10^{23} \text{ mol}^{-1}$
molar gas constant	$R = 8.31 \text{ J K}^{-1} \text{ mol}^{-1}$
Boltzmann constant	$k = 1.38 \times 10^{-23} \text{ J K}^{-1}$
gravitational constant	$G = 6.67 \times 10^{-11} \text{ N m}^2 \text{ kg}^{-2}$
permittivity of free space	$\epsilon_0 = 8.85 \times 10^{-12} \text{ F m}^{-1}$ $(\frac{1}{4\pi\epsilon_0} = 8.99 \times 10^9 \text{ m F}^{-1})$
Planck constant	$h = 6.63 \times 10^{-34} \text{ J s}$
Stefan–Boltzmann constant	$\sigma = 5.67 \times 10^{-8} \text{ W m}^{-2} \text{ K}^{-4}$

Formulae

uniformly accelerated motion	$s = ut + \frac{1}{2}at^2$ $v^2 = u^2 + 2as$
hydrostatic pressure	$\Delta p = \rho g \Delta h$
upthrust	$F = \rho g V$
Doppler effect for sound waves	$f_o = \frac{f_s v}{v \pm v_s}$
electric current	$I = Anvq$
resistors in series	$R = R_1 + R_2 + \dots$
resistors in parallel	$\frac{1}{R} = \frac{1}{R_1} + \frac{1}{R_2} + \dots$

- 1 Which quantity is a physical quantity?
- A flavour
 - B kelvin
 - C minute
 - D potential difference
- 2 What is a power of 3.7 MW when expressed in kilowatts?
- A 3.7×10^{-3} kW
 - B 3.7×10^{-3} KW
 - C 3.7×10^3 kW
 - D 3.7×10^3 KW
- 3 A spring is suspended from a fixed point and a force is applied. The position of a pointer attached to the bottom of the spring against a vertical ruler is recorded.
- Before the force is applied, the position of the pointer is (225 ± 2) mm.
- After the force is applied, the position of the pointer is (250 ± 2) mm.
- The extension of the spring is determined.
- What is the percentage uncertainty in the extension?
- A 1.6%
 - B 1.8%
 - C 8.0%
 - D 16%
- 4 What is the difference between a scalar quantity and a vector quantity?
- A A scalar quantity has direction but a vector quantity does not.
 - B A scalar quantity has magnitude but a vector quantity does not.
 - C A vector quantity has direction but a scalar quantity does not.
 - D A vector quantity has magnitude but a scalar quantity does not.

4

- 5 A toy car travels on a circular track at a constant speed of 0.50 m s^{-1} . It passes a point on the track at time $t = 0$ and takes a time of 40 s to travel once around the track.

The magnitude of the average velocity of the car between $t = 0$ and $t = 20 \text{ s}$ is v_{20} .

The magnitude of the average velocity of the car between $t = 0$ and $t = 40 \text{ s}$ is v_{40} .

What are v_{20} and v_{40} ?

	$v_{20}/\text{m s}^{-1}$	$v_{40}/\text{m s}^{-1}$
A	0.32	0
B	0.32	0.32
C	0.50	0
D	0.50	0.50

- 6 The graph shows how the velocity v of an object moving in a straight line varies with time t from $t = 0$ to $t = T$.

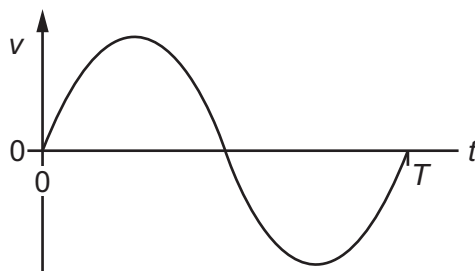

Which graph could represent the displacement s of the object from time $t = 0$ to $t = T$?

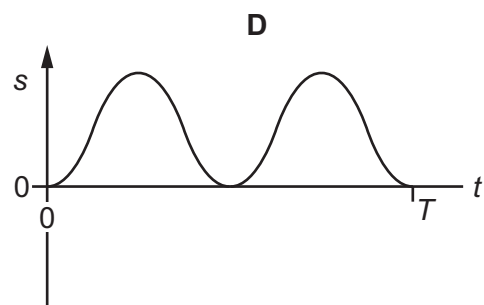
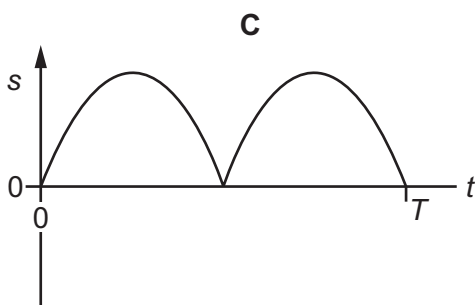
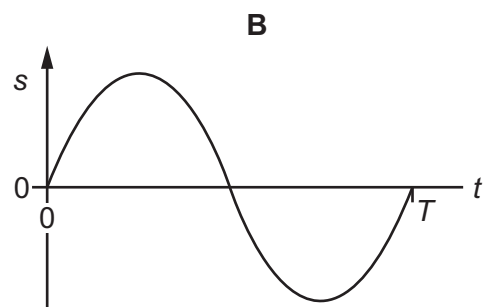
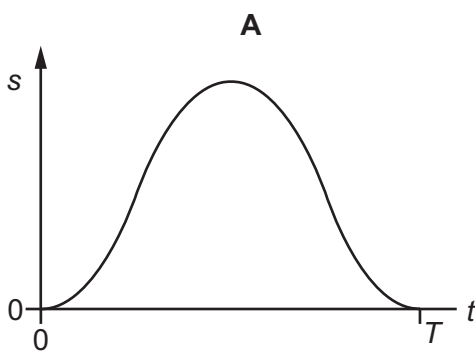

- 7 A goods train passes through a station at a steady speed of 10 m s^{-1} at time $t = 0$. An express train is at rest at the station. The express train leaves the station with a uniform acceleration of 0.5 m s^{-2} just as the goods train goes past. Both trains move in the same direction on straight, parallel tracks.

At which time t does the express train overtake the goods train?

- A 6 s B 10 s C 20 s D 40 s

- 8 A constant resultant force F acts on an object of mass m for time t .

What is the change in momentum of the object?

- A $\frac{F}{t}$ B $\frac{Ft}{m}$ C Ft D $\frac{F}{mt}$

- 9 The acceleration of free fall on the surface of planet P is one-tenth of that on the surface of planet Q.

On the surface of P, an object has a mass of 1.0 kg and a weight of 1.0 N.

What are the mass and the weight of the same object on the surface of planet Q?

	mass on Q/kg	weight on Q/N
A	1.0	0.1
B	1.0	10
C	10	10
D	10	100

- 10 A parachutist falls from rest from a balloon. The variation with time of the vertical velocity of the parachutist is shown.

In which region is the force due to air resistance much greater than the weight of the parachutist?

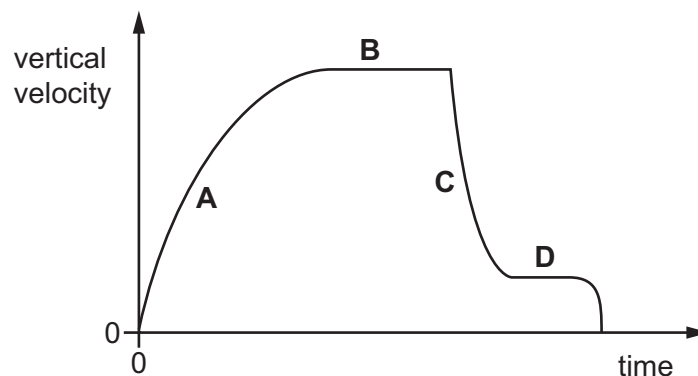

- 11 Two solid spheres form an isolated system. Sphere X moves with speed 6 cm s^{-1} in a straight line directly towards a stationary sphere Y, as shown.

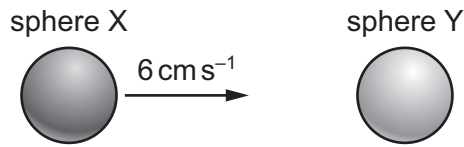

The spheres have a perfectly elastic collision. After the collision, sphere X moves with speed 2 cm s^{-1} in the same direction as before the collision.

What is the speed of sphere Y?

- A 2 cm s^{-1} B 4 cm s^{-1} C 6 cm s^{-1} D 8 cm s^{-1}
- 12 What is **not** a necessary requirement of the forces in a couple?
- A They act in opposite directions.
 B They act along different lines.
 C They have the same magnitude.
 D They produce a resultant force.
- 13 A box of length 12 cm and weight 0.43 N is placed on a horizontal table, with the greater part of its length overhanging the edge of the table. The edge of the table acts as a pivot. The centre of gravity of the box is at its geometric centre.

To balance the box, a uniform sphere of diameter 2.4 cm is placed inside the box, touching one end, as shown.

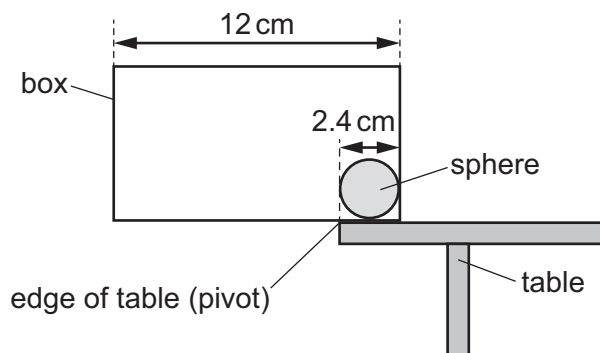

Assume that the forces acting on the box are in the plane of the diagram.

What is the minimum mass of the sphere that is needed to maintain the system in equilibrium?

- A 0.066 kg B 0.13 kg C 0.22 kg D 1.3 kg

- 14 An object is suspended by two ropes. One rope has a tension of 410 N at an angle of 60° to the horizontal. The other rope has a tension of 210 N at an angle of 10° to the horizontal.

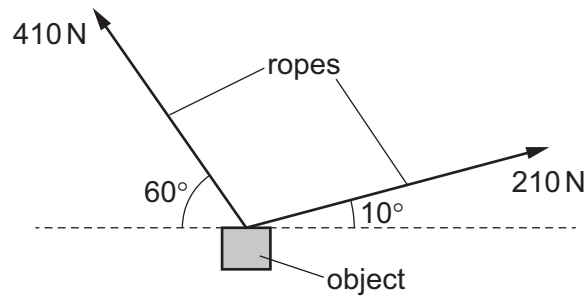

The object is in equilibrium.

What is the mass of the object?

- A 40 kg B 42 kg C 390 kg D 410 kg
- 15 A solid cube is floating in equilibrium in liquid mercury. The cube is made of iron of density 7900 kg m^{-3} .
- The cube floats with 42% of its volume above the surface of the mercury.

What is the density of the mercury?

- A 3300 kg m^{-3}
 B 4600 kg m^{-3}
 C $14\,000 \text{ kg m}^{-3}$
 D $19\,000 \text{ kg m}^{-3}$
- 16 The diagram shows two vessels, P and Q, both with sides inclined at 45° to the horizontal.

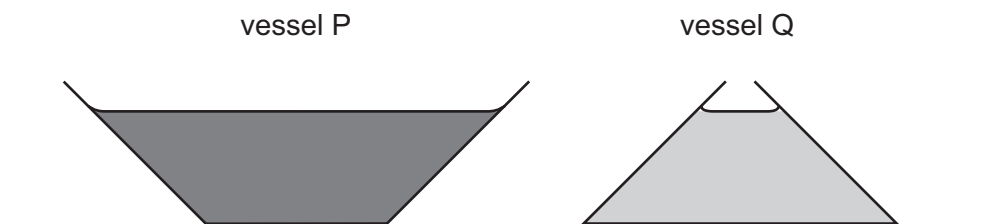

Vessel P tapers outwards and vessel Q tapers inwards, as shown.

Both vessels contain a liquid. The depth of the liquid in the vessels is the same. The liquid in vessel P is twice as dense as the liquid in vessel Q.

What is the ratio $\frac{\text{pressure due to the liquid on the base of P}}{\text{pressure due to the liquid on the base of Q}}$?

- A $\frac{2}{1}$ B $\frac{\sqrt{2}}{1}$ C $\frac{1}{\sqrt{2}}$ D $\frac{1}{2}$

- 17 A motor is used to lift a load vertically upwards.

The load has weight W .

The motor produces useful power output P .

The load is lifted at constant velocity v .

Which expression gives the time taken for the motor to lift the load vertically upwards through a distance d ?

- A $\frac{P}{Wd}$ B $\frac{Wv}{P}$ C $\frac{Wd}{P}$ D $\frac{Pv}{W}$

- 18 A lamp is switched on for 2.0 hours. The power input to the lamp is 1.0W. The energy given out by the lamp as light is 7.0×10^3 J.

How much energy is converted to other forms by the lamp?

- A 120 J B 200 J C 3400 J D 7200 J

- 19 An object of mass m is dropped onto the surface of two planets, X and Y, which have no atmosphere.

The height from which the object is dropped and the change in gravitational potential energy of the object, for each planet, are given in the table.

	height / m	change in gravitational potential energy
planet X	3	ΔE
planet Y	4	$4\Delta E$

The acceleration of free fall near the surface of planet X is g_x .

What is the acceleration of free fall near the surface of planet Y?

- A $\frac{3}{4}g_x$ B $\frac{4}{3}g_x$ C $3g_x$ D $4g_x$

- 20 A known tensile force acts on a metal wire. The wire does not exceed its limit of proportionality.

Which two measurements enable the strain of the wire to be calculated?

- A the unstretched length of the wire and the cross-sectional area of the wire
 B the unstretched length of the wire and the extension of the wire
 C the Young modulus of the metal and the extension of the wire
 D the Young modulus of the metal and the unstretched length of the wire

21 A wire is extended by different forces. The wire obeys Hooke's law.

A graph is plotted to show the variation of a quantity y with a quantity x .

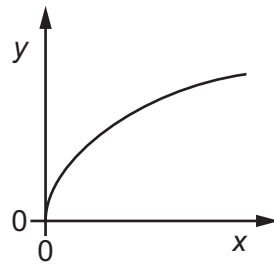

What could x and y represent?

	x	y
A	elastic potential energy	extension
B	extension	force
C	force	extension
D	extension	elastic potential energy

22 A wave pulse moves along a stretched rope in the direction shown.



Which diagram shows the variation with time t of the displacement s of the particle P in the rope?

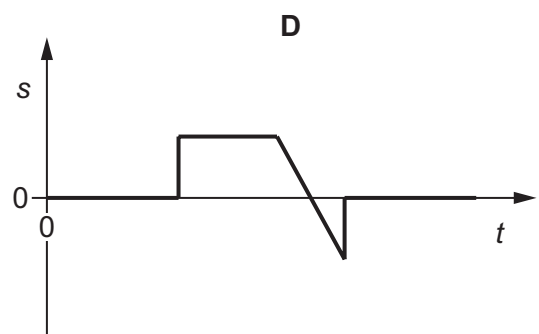
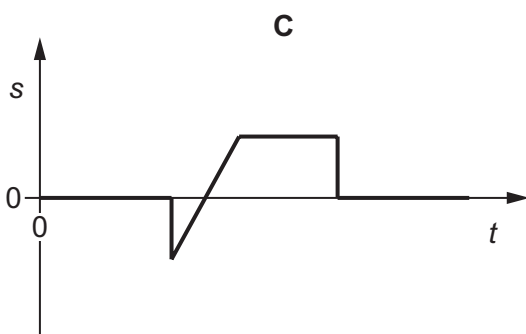
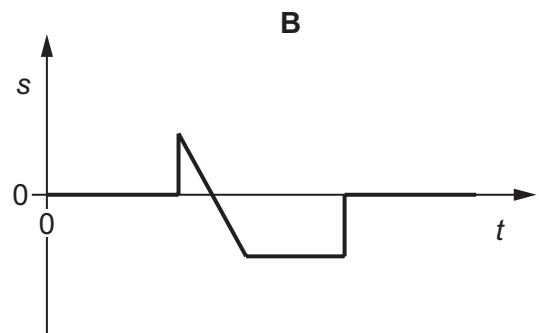
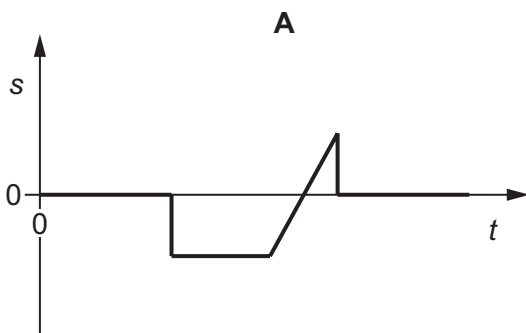

- 23 Which statement about progressive transverse and longitudinal waves is correct?
- A Particles in a transverse wave have fixed equilibrium positions but those in longitudinal waves do not.
 - B Transverse waves can be polarised but longitudinal waves cannot.
 - C Transverse waves transfer energy but longitudinal waves do not.
 - D Two-source interference can be demonstrated with transverse waves but not with longitudinal waves.

- 24 A miniature loudspeaker, initially at rest, falls vertically from a window in a high building. When the speaker has fallen a distance of 10.0 m, it emits a very short pulse of sound of constant frequency 256 Hz in all directions. The pulse of sound, travelling at a speed of 330 ms^{-1} , is heard by a person leaning out of the window.

Air resistance is negligible.

What is the frequency of the pulse of sound heard by the person?

- A 246 Hz B 249 Hz C 267 Hz D 313 Hz
- 25 Two electromagnetic waves have wavelengths of $5.0 \times 10^{-7} \text{ m}$ and $5.0 \times 10^{-2} \text{ m}$ in a vacuum.

Which row identifies the regions of the electromagnetic spectrum to which the waves belong?

	wavelength $5.0 \times 10^{-7} \text{ m}$	wavelength $5.0 \times 10^{-2} \text{ m}$
A	ultraviolet	infrared
B	visible	microwave
C	ultraviolet	microwave
D	visible	infrared

- 26 The wavelength of sound in air may be determined by using stationary waves.

In one experiment, a loudspeaker produces a sound wave of constant frequency which is reflected directly back along its original path by a metal plate approximately 1 m away. A microphone connected to a cathode-ray oscilloscope (CRO) is moved between the loudspeaker and plate to identify regions of high sound intensity ('loud' spots) and low sound intensity ('quiet' spots).

The wavelength of the sound is determined using the **least** possible number of measured quantities.

Which row shows the quantities that are needed?

	frequency of sound	mean separation of 'quiet' spots	speed of sound in air
A	✓	✓	✗
B	✓	✗	✓
C	✓	✗	✗
D	✗	✓	✗

key

✓ = needed

✗ = not needed

- 27 Two progressive waves meet at a fixed point P. The variation with time of the displacement of each wave at point P is shown.

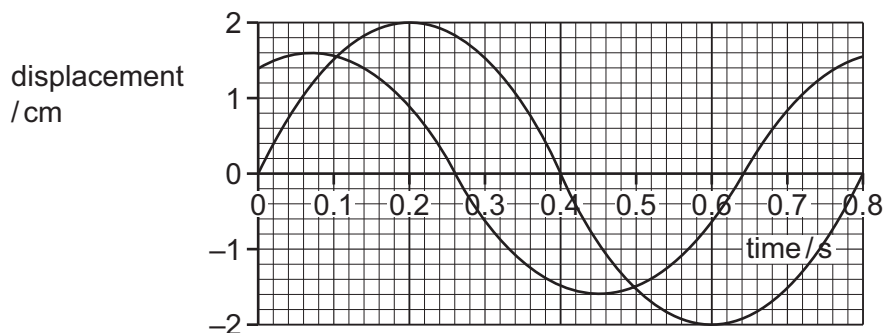

The two waves superpose at point P.

What is the resultant displacement at time 0.38 s?

- A** +1.0 cm **B** -1.0 cm **C** +1.8 cm **D** -1.8 cm
- 28 In which situation does diffraction occur?
- A** A wave bounces back from a surface.
- B** A wave passes from one medium into another.
- C** A wave passes through a gap in a barrier.
- D** Waves from two identical sources are superposed.

- 29 Light of a single frequency is incident on a pair of narrow slits that are a distance of 0.10 mm apart. A series of bright and dark fringes is observed on a screen a distance of 2.0 m away. The distance between adjacent bright fringes is 8.0 mm.

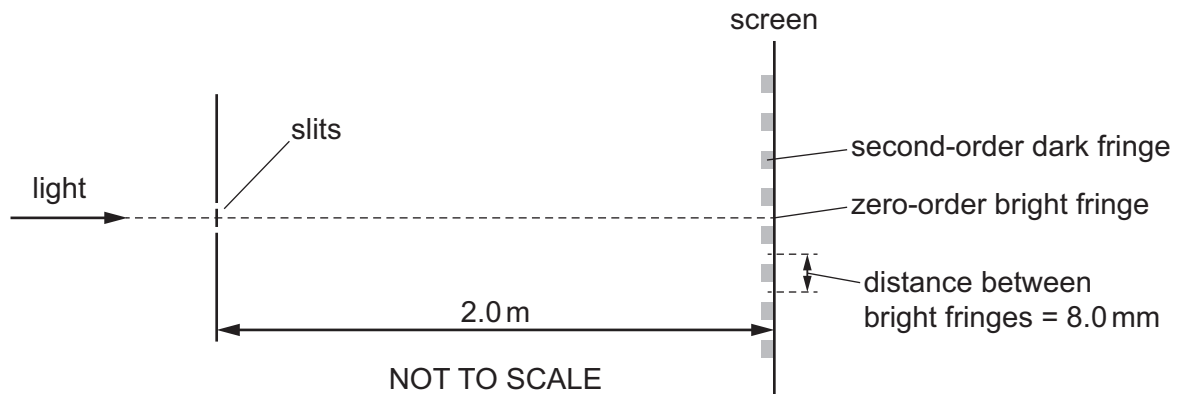

What is the path difference of the light waves from the two slits that meet at the second-order **dark** fringe?

- A 2.0×10^{-7} m
 B 4.0×10^{-7} m
 C 6.0×10^{-7} m
 D 8.0×10^{-7} m
- 30 Red light of a single wavelength passes through a diffraction grating. Bright dots are formed on a screen, as shown.



The red light is replaced with white light.

Which diagram, drawn to the same scale, shows a possible pattern of bright light on the screen?

- A
- B
- C
- D

- 31 A nichrome wire has a resistance of $15\ \Omega$ and a diameter of 3.0 mm. The number density of the free electrons in nichrome is $9.0 \times 10^{28}\ \text{m}^{-3}$.

A potential difference (p.d.) of 6.0 V is applied between the ends of the wire.

What is the average drift speed of the free electrons in the wire?

- A $9.8 \times 10^{-7}\ \text{m s}^{-1}$
 B $3.9 \times 10^{-6}\ \text{m s}^{-1}$
 C $6.1 \times 10^{-6}\ \text{m s}^{-1}$
 D $2.5 \times 10^{-5}\ \text{m s}^{-1}$
- 32 The diagrams show two different circuits.

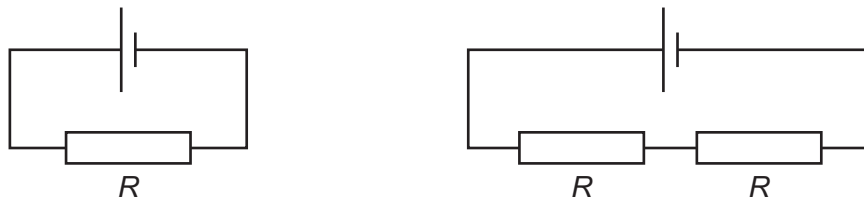

The cells in each circuit have the same electromotive force (e.m.f.) and negligible internal resistance. The three resistors each have the same resistance R .

In the circuit on the left, the power dissipated in the resistor is P .

What is the total power dissipated in the circuit on the right?

- A $\frac{P}{4}$ B $\frac{P}{2}$ C P D $2P$
- 33 The potential difference (p.d.) across a filament lamp is increased.

Which statement is correct?

- A The resistance of the lamp decreases because the temperature decreases.
 B The resistance of the lamp decreases because the temperature increases.
 C The resistance of the lamp increases because the temperature decreases.
 D The resistance of the lamp increases because the temperature increases.

- 34 A metal wire has resistance R .

The wire is stretched so that its diameter decreases to 94.0% of the original diameter.

The volume of the wire is unchanged.

What is the resistance of the stretched wire?

- A $1.06R$ B $1.13R$ C $1.20R$ D $1.28R$

- 35 The diagram shows a cell of electromotive force (e.m.f.) 3.0V and internal resistance 4.7Ω connected across a lamp. The lamp has a resistance of 9.3Ω .

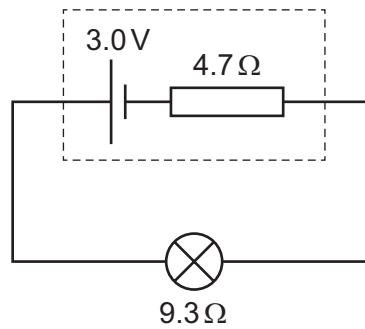

What is the power dissipated by the internal resistance of the cell?

- A 0.22W B 0.43W C 0.64W D 1.0W
- 36 A circuit consists of a battery, a high-resistance voltmeter and four fixed resistors, as shown. The battery has an electromotive force (e.m.f.) of 15.0V and negligible internal resistance.

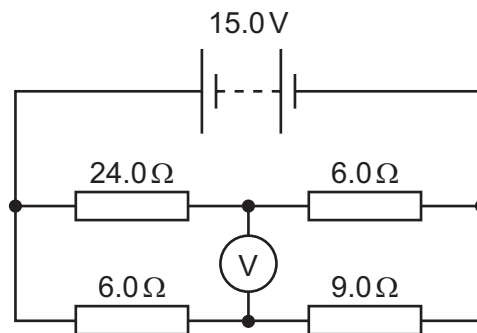

What is the reading on the voltmeter?

- A 3.0V B 6.0V C 9.0V D 12.0V

- 37 A potential divider circuit is designed to detect the difference in temperature between two different places.

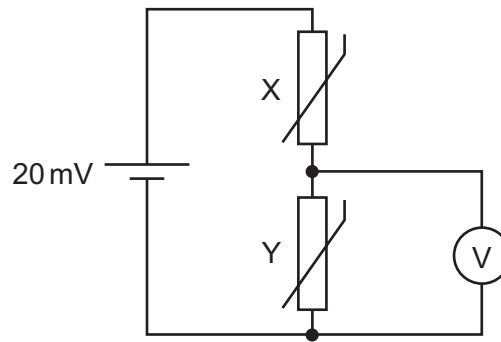

The cell has electromotive force (e.m.f.) 20 mV and negligible internal resistance.

Initially, thermistors X and Y are at the same temperature and have the same resistance. The voltmeter reads 10 mV. X is then placed in a cold environment and its resistance doubles. Y is placed in a warm environment and its resistance halves.

What is the new reading on the voltmeter?

- A** 4 mV **B** 5 mV **C** 15 mV **D** 16 mV
- 38 In the α -particle scattering experiment, a beam of α -particles is aimed at a thin gold foil. Most of the α -particles go straight through or are deflected by a small angle. A very small proportion are deflected by more than 90° , effectively rebounding towards the source of the α -particles.
- Which conclusion about the structure of atoms **cannot** be drawn from this experiment alone?
- A** Most of the atom is empty space.
B Most of the mass of an atom is concentrated in the nucleus.
C The nucleus contains both protons and neutrons.
D The nucleus is charged.
- 39 Which two particles have opposite charges?
- A** alpha-particle and helium nucleus
B antiproton and beta-plus particle
C beta-minus particle and electron
D positron and proton

40 Which particle is a lepton?

- A meson
- B positron
- C proton
- D quark

Permission to reproduce items where third-party owned material protected by copyright is included has been sought and cleared where possible. Every reasonable effort has been made by the publisher (UCLES) to trace copyright holders, but if any items requiring clearance have unwittingly been included, the publisher will be pleased to make amends at the earliest possible opportunity.

To avoid the issue of disclosure of answer-related information to candidates, all copyright acknowledgements are reproduced online in the Cambridge Assessment International Education Copyright Acknowledgements Booklet. This is produced for each series of examinations and is freely available to download at www.cambridgeinternational.org after the live examination series.

Cambridge Assessment International Education is part of Cambridge Assessment. Cambridge Assessment is the brand name of the University of Cambridge Local Examinations Syndicate (UCLES), which is a department of the University of Cambridge.