

## UNIVERSITY OF CAMBRIDGE INTERNATIONAL EXAMINATIONS

International General Certificate of Secondary Education

### MARK SCHEME for the May/June 2006 question paper

#### 0445 DESIGN AND TECHNOLOGY

0445/04

Paper 4, maximum raw mark 60

These mark schemes are published as an aid to teachers and students, to indicate the requirements of the examination. They show the basis on which Examiners were initially instructed to award marks. They do not indicate the details of the discussions that took place at an Examiners' meeting before marking began. Any substantial changes to the mark scheme that arose from these discussions will be recorded in the published *Report on the Examination*.

All Examiners are instructed that alternative correct answers and unexpected approaches in candidates' scripts must be given marks that fairly reflect the relevant knowledge and skills demonstrated.

Mark schemes must be read in conjunction with the question papers and the *Report on the Examination*.

The minimum marks in these components needed for various grades were previously published with these mark schemes, but are now instead included in the Report on the Examination for this session.

- CIE will not enter into discussion or correspondence in connection with these mark schemes.

CIE is publishing the mark schemes for the May/June 2006 question papers for most IGCSE and GCE Advanced Level and Advanced Subsidiary Level syllabuses and some Ordinary Level syllabuses.

Page 1	Mark Scheme	Syllabus	
	IGCSE – May/June 2006	0445	

1 (a)

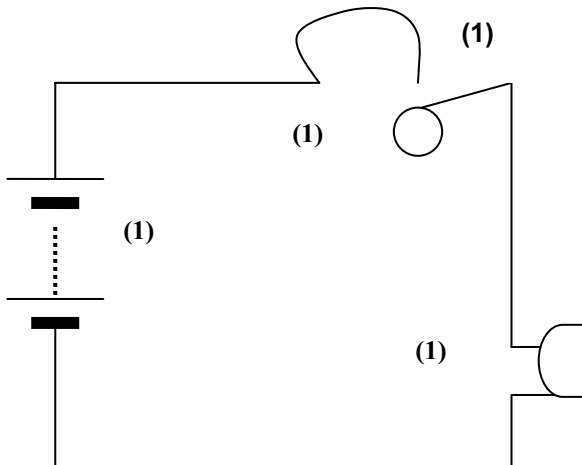

[4]

- (b) (i) 1. Compact/easy to install (2)  
 2. Variable frequency/more sensitive (2)

[4]

(ii) To allow adjustment (1) and to vary the frequency (1) of the speaker (1)

[3]







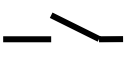

(iii) All correct (3)/half correct (2)/some correct (1)

[3]

(iv) Electrolytic

[1]

(c)

INPUT		TIMER		CONTROL		Speaker
Slide switch		Capacitor / resistor (1)		555 IC		Speaker
						
(1)		(1)				
						
(2)						

[5]

Page 2	Mark Scheme	Syllabus	
	IGCSE – May/June 2006	0445	

- (d) (i)  $R = 100\text{K}\Omega$  (1)  
 $C = 1000\mu\text{F}$  (1)
- (ii)  $T = 100$  Seconds [1]
- (iii)  $T = 1.1$  (1)  $\times C \times R$  (1) [2]
- (e) (i) 1. The values of resistors (1) are inaccurate (1)  
2. The values of capacitors (1) are inaccurate (1) [4]
- (ii) Variable resistor [1]
- 2 (a) 1. Pulley (1)  
2. Worm gear (1)  
3. Cam (1) [3]
- (b) Rotary motion (1) of the motor causes the worm gear to rotate (1) this turns the worm wheel changing motion through  $90^\circ$  (1) driving the pulley which turns the cams (1) that convert motion to reciprocation (1) and switch on and off the bank of switches. [5]
- (c) (i) Friction [1]
- (ii) Lubrication/use of low friction materials [2]
- (d) (i) Brass/nylon [1]
- (ii) Low friction (1) and does not corrode (1) hence works efficiently (1) [3]
- (e) (i) 1. Bevel gears (1)  
2. Bell crank lever (1) [2]
- (ii) 1. Hand drill (1)  
2. Altimeter (1) [2]
- (iii) Parts (1)  
Input (1)  
Output (1) [3]
- (f) (i)  $R = \text{Teeth on driver}/\text{Teeth on driven} = 18/12$  (1)  
 $R = 3/2$  (1) i.e.  $R = 3:2$  (1) [3]
- (ii) Output speed = Input speed  $\times 3/2$  (1)  
Output speed =  $200 \text{ rpm} \times 3/2$  (1)  
Output speed =  $300 \text{ rpm}$  (1) [3]
- (iii) An idler gear (1) is added between (1) the two gear wheels [2]

Page 3	Mark Scheme	Syllabus
	IGCSE – May/June 2006	0445

- 3 (a) Beam B has greater rigidity (1) and can withstand bending forces more readily (1). Its section is deeper and offers more resistance to bending (1).

(b)

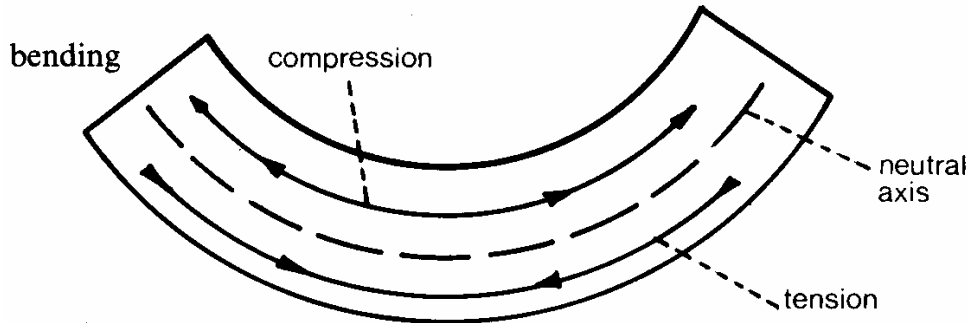

[4]

- (c) For equilibrium Forces up = forces down

$$150\text{N} = \text{RL} + \text{RR} \quad (1)$$

$$150\text{N}/2 \quad (1) = \text{RL} = \text{RR} = 75\text{N} \quad (1)$$

[3]

- (d) (i) They are lighter (1) and offer greater strength to weight ratio (1) they are therefore more economical in use (1).

[3]

- (ii) The beam is so designed to carry the maximum internal forces (1) where they act most (1) at the outer edges (1) of a beam.

[3]

- (iii) Roof girder/tent poles/columns/posts/shelf supports.

[2]

- (iv) Welding/gusset plates/nuts and bolts/riveting:

Correct method (1)

Sketch (1)

Labels/notes (1)

[3]

Page 4	Mark Scheme	Syllabus	
	IGCSE – May/June 2006	0445	

(e) (i)

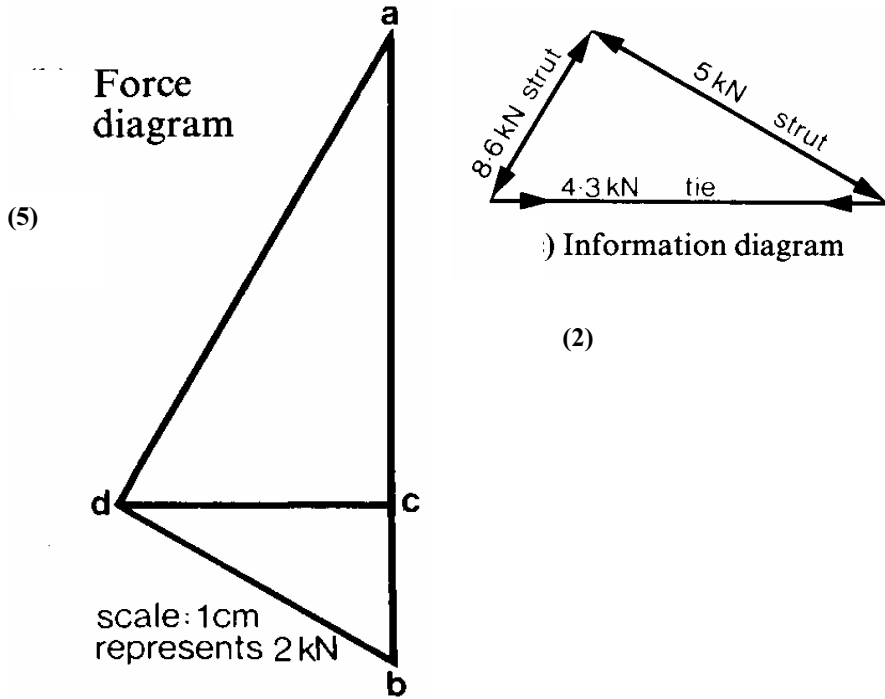

[7]

(ii)

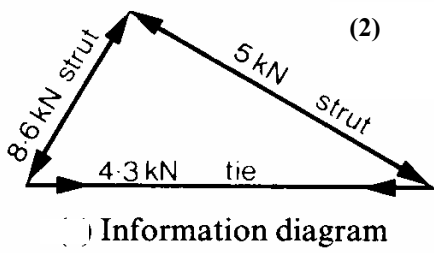

[2]

Page 5	Mark Scheme	Syllabus	
	IGCSE – May/June 2006	0445	

4 (a) Energy stored in spring is potential (1). This is converted (1) to kinetic energy (1) on release of spring.

(b)

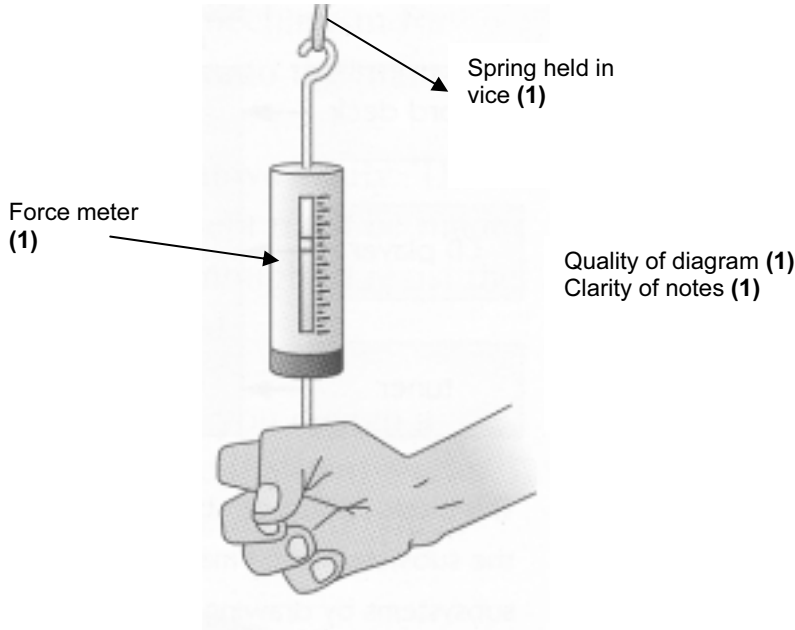

[4]

(c) The property of a material that allows it to support a load (1) but allows the material to return to original length (1) when loading is removed (1)

[3]

(d)

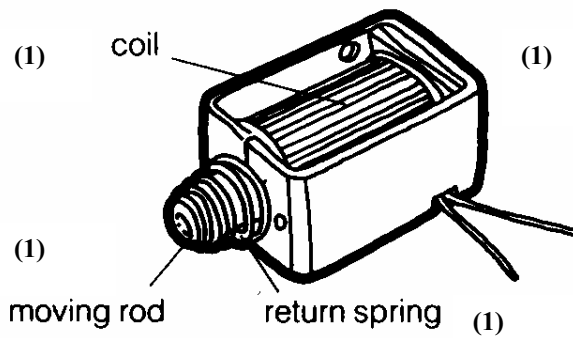

[4]

Page 6	Mark Scheme	Syllabus
	IGCSE – May/June 2006	0445

(e)

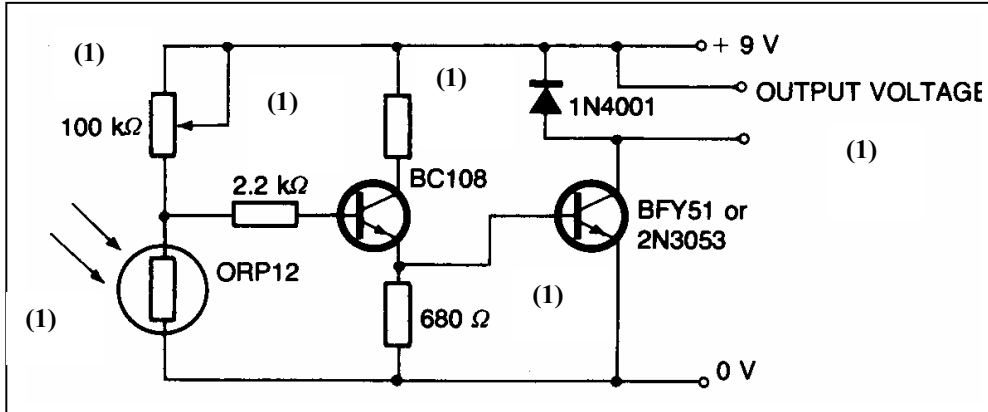

[6]

(f) (i)

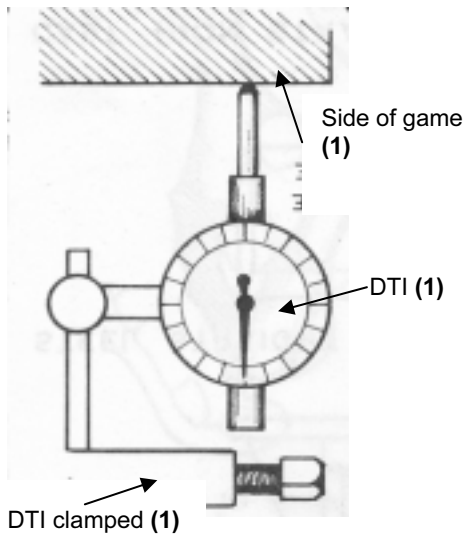

Quality of diagram (1)

[4]

(ii) Strain =  $\delta L/L$

Strain = 0.01mm/80mm (1)

Strain = 0.000125 (1) units (1)

[3]

(iii) Dynamic loads are moving loads (1). They increase the forces due to impact loading (1).

Diagram (1)

[3]