



Cambridge IGCSE™

CANDIDATE
NAME

CENTRE
NUMBER

--	--	--	--	--

CANDIDATE
NUMBER

--	--	--	--

MATHEMATICS

0580/22

Paper 2 (Extended)

February/March 2022

1 hour 30 minutes

You must answer on the question paper.

You will need: Geometrical instruments

INSTRUCTIONS

- Answer **all** questions.
- Use a black or dark blue pen. You may use an HB pencil for any diagrams or graphs.
- Write your name, centre number and candidate number in the boxes at the top of the page.
- Write your answer to each question in the space provided.
- Do **not** use an erasable pen or correction fluid.
- Do **not** write on any bar codes.
- You should use a calculator where appropriate.
- You may use tracing paper.
- You must show all necessary working clearly.
- Give non-exact numerical answers correct to 3 significant figures, or 1 decimal place for angles in degrees, unless a different level of accuracy is specified in the question.
- For π , use either your calculator value or 3.142.

INFORMATION

- The total mark for this paper is 70.
- The number of marks for each question or part question is shown in brackets [].

This document has **12** pages. Any blank pages are indicated.



2

1

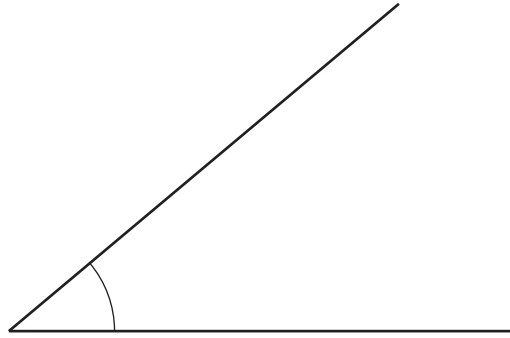

Measure the marked angle.

..... [1]

2 Work out $\sqrt{5} \times 6^2$.
Give your answer correct to 2 decimal places.

..... [2]

3 A journey starts at 21 15 one day and ends at 04 33 the next day.
Calculate the time taken, in hours and minutes.

..... h min [1]

4

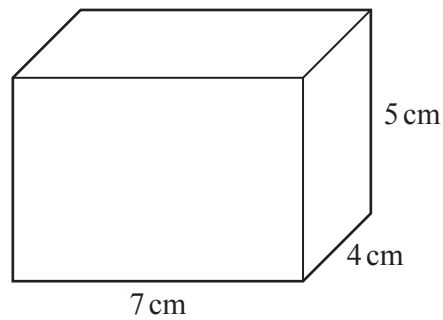

NOT TO
SCALE

Calculate the **total** surface area of this cuboid.

..... cm^2 [3]

3

- 5 (a) Write down the gradient of the line $y = 5x + 7$.

..... [1]

- (b) Find the coordinates of the point where the line $y = 5x + 7$ crosses the y -axis.

(.....,) [1]

6

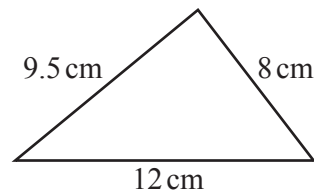

NOT TO
SCALE

Using a ruler and compasses only, construct this triangle.
Leave in your construction arcs.
The side of length 12 cm has been drawn for you.

.....

[2]

7

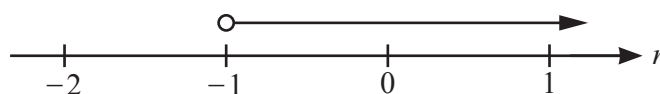

Write down the inequality, in terms of n , shown by the number line.

..... [1]

8

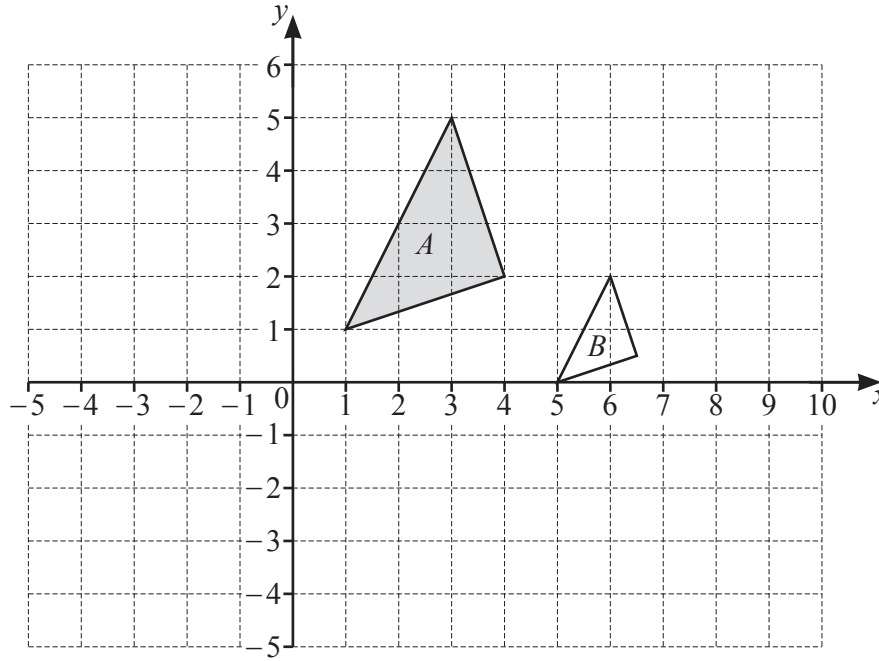

- (a) On the grid, draw the image of
- (i) triangle *A* after a reflection in the *y*-axis, [1]
 - (ii) triangle *A* after a translation by the vector $\begin{pmatrix} -3 \\ -4 \end{pmatrix}$. [2]
- (b) Describe fully the **single** transformation that maps triangle *A* onto triangle *B*.
-
- [3]

9 Factorise completely.

$$12a^3 - 21a$$

..... [2]

- 10 (a) The n th term of a sequence is $n^2 + 7$.

Find the first three terms of this sequence.

.....,, [2]

- (b) These are the first four terms of a different sequence.

15 7 -1 -9

Find the n th term of this sequence.

..... [2]

- 11 As the temperature increases, people eat more ice cream.

What type of correlation does this statement describe?

..... [1]

- 12 (a) Sanjay invests \$700 in an account paying simple interest at a rate of 2.5% per year.

Calculate the value of his investment at the end of 6 years.

\$ [3]

- (b) Meera invests \$700 in an account paying compound interest at a rate of $r\%$ per year.
At the end of 17 years the value of her investment is \$1030.35 .

Find the value of r .

$r =$ [3]

13 (a) Simplify $h^2 \times h^5$.

..... [1]

(b) Simplify $\left(\frac{7}{x}\right)^{-3}$.

..... [1]

(c) $a^8 \div a^p = a^2$

Find the value of p .

$p =$ [1]

14 Calculate the circumference of a circle with radius 4.7 cm.

..... cm [2]

15 **Without using a calculator**, work out $2\frac{1}{3} \times \frac{11}{14}$.

You must show all your working and give your answer as a mixed number in its simplest form.

..... [3]

16

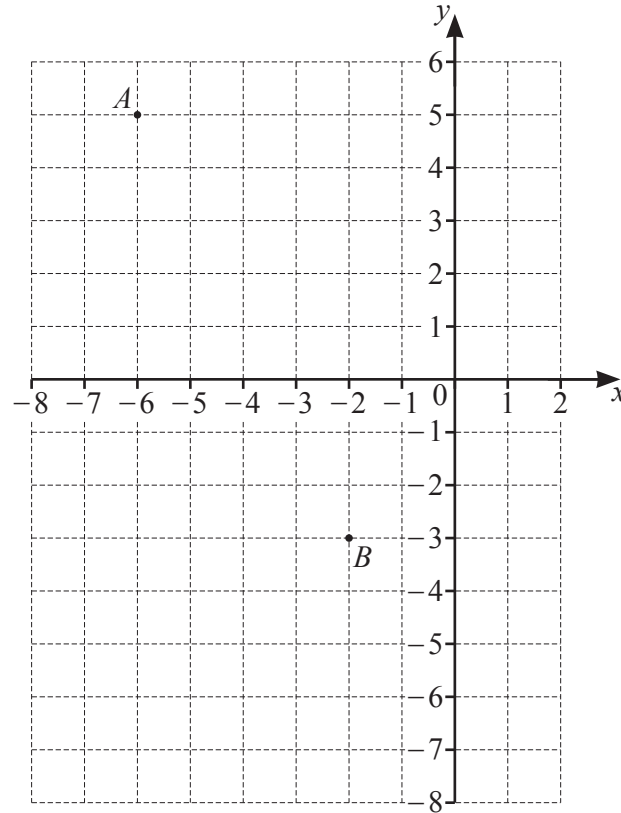

A is the point $(-6, 5)$ and B is the point $(-2, -3)$.

- (a) Find the equation of the straight line, l , that passes through point A and point B .
Give your answer in the form $y = mx + c$.

$$y = \dots\dots\dots [2]$$

- (b) Find the equation of the line that is perpendicular to l and passes through the origin.

$$\dots\dots\dots [2]$$

17

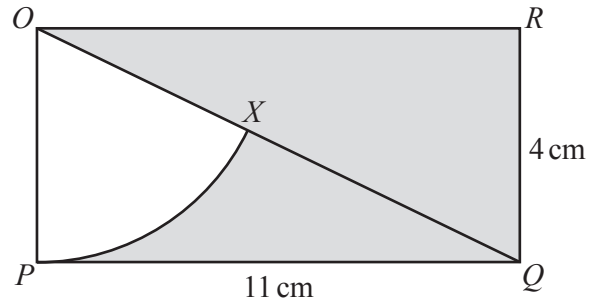
NOT TO
SCALE

The diagram shows a rectangle $OPQR$ with length 11 cm and width 4 cm. OQ is a diagonal and OPX is a sector of a circle, centre O .

Calculate the percentage of the rectangle that is shaded.

..... % [5]

18 Mrs Kohli buys a jacket, 2 shirts and a hat.

The jacket costs \$ x .

The shirts each cost \$24 less than the jacket and the hat costs \$16 less than the jacket.

Mrs Kohli spends exactly \$100.

Write down an equation in terms of x .

Solve this equation to find the cost of the jacket.

\$ [3]

9

- 19 y is inversely proportional to the square root of $(x + 4)$.
When $x = 5, y = 2$.

Find y when $x = 77$.

$$y = \dots\dots\dots [3]$$

- 20 Solve the simultaneous equations.
You must show all your working.

$$\begin{aligned} 3x + y &= 11 \\ x^2 - 2y &= 18 \end{aligned}$$

$$x = \dots\dots\dots y = \dots\dots\dots$$

$$x = \dots\dots\dots y = \dots\dots\dots [5]$$

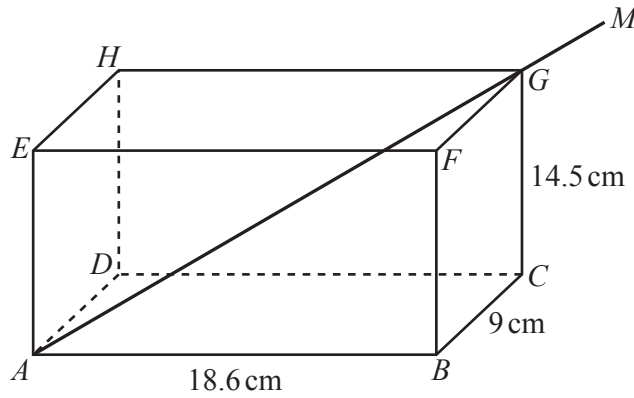
NOT TO
SCALE

The diagram shows an open rectangular box $ABCDEFGH$.

$AB = 18.6$ cm, $BC = 9$ cm and $CG = 14.5$ cm.

A straight stick AGM rests against A and G and extends outside the box to M .

(a) Calculate the angle between the stick and the base of the box.

..... [4]

(b) $AM = 30$ cm.

Show that $GM = 4.8$ cm, correct to 1 decimal place.

[3]

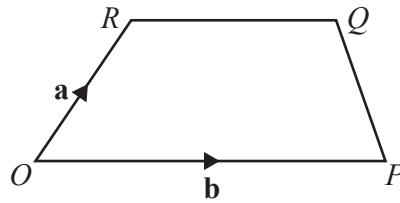

NOT TO
SCALE

The diagram shows a trapezium $OPQR$.

O is the origin, $\vec{OR} = \mathbf{a}$ and $\vec{OP} = \mathbf{b}$.

$$|\vec{RQ}| = \frac{3}{5}|\vec{OP}|$$

(a) Find \vec{PQ} in terms of \mathbf{a} and \mathbf{b} in its simplest form.

$$\vec{PQ} = \dots\dots\dots [2]$$

(b) When PQ and OR are extended, they intersect at W .

Find the position vector of W .

$$\dots\dots\dots [2]$$

BLANK PAGE

Permission to reproduce items where third-party owned material protected by copyright is included has been sought and cleared where possible. Every reasonable effort has been made by the publisher (UCLES) to trace copyright holders, but if any items requiring clearance have unwittingly been included, the publisher will be pleased to make amends at the earliest possible opportunity.

To avoid the issue of disclosure of answer-related information to candidates, all copyright acknowledgements are reproduced online in the Cambridge Assessment International Education Copyright Acknowledgements Booklet. This is produced for each series of examinations and is freely available to download at www.cambridgeinternational.org after the live examination series.

Cambridge Assessment International Education is part of Cambridge Assessment. Cambridge Assessment is the brand name of the University of Cambridge Local Examinations Syndicate (UCLES), which is a department of the University of Cambridge.