



UNIVERSITY OF CAMBRIDGE INTERNATIONAL EXAMINATIONS
International General Certificate of Secondary Education

CANDIDATE
NAME

CENTRE
NUMBER

--	--	--	--	--

CANDIDATE
NUMBER

--	--	--	--

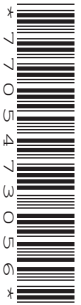

PHYSICS

0625/62

Paper 6 Alternative to Practical

May/June 2013

1 hour

Candidates answer on the Question Paper.

No Additional Materials are required.

READ THESE INSTRUCTIONS FIRST

Write your Centre number, candidate number and name on all the work you hand in.

Write in dark blue or black pen.

You may use a pencil for any diagrams or graphs.

Do not use staples, paper clips, highlighters, glue or correction fluid.

DO NOT WRITE IN ANY BARCODES.

Answer **all** questions.

Electronic calculators may be used.

You may lose marks if you do not show your working or if you do not use appropriate units.

At the end of the examination, fasten all your work securely together.

The number of marks is given in brackets [] at the end of each question or part question.

This document consists of **16** printed pages.



1 The IGCSE class is determining the mass of a metre rule using two methods.

Method 1.

Fig. 1.1 shows the apparatus used.

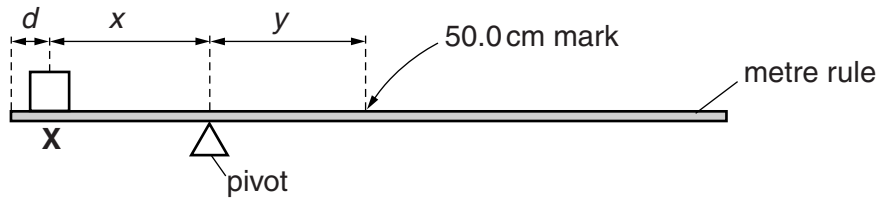

Fig. 1.1

A student places a 100 g mass **X** on the rule so that its centre is at a distance $d = 5.0$ cm from the zero end of the rule, as shown in Fig. 1.1. He adjusts the position of the rule so that it is as near as possible to being balanced.

He measures the distance x from the centre of the mass **X** to the pivot and the distance y from the pivot to the 50.0 cm mark on the rule.

He repeats the procedure using $d = 10.0$ cm.

The readings are shown in Table 1.1.

Table 1.1

d/cm	x/cm	y/cm
5.0	23.7	21.1
10.0	21.0	18.5

(a) (i) Using the values of x and y in the first row of the table, calculate the mass M of the rule using the equation

$$M = \frac{100x}{y}.$$

$M = \dots\dots\dots$

3

(ii) Repeat step (a)(i) using the values of x and y in the second row of the table.

$M = \dots\dots\dots$ [2]

(iii) Calculate the average value of M .

average value of $M = \dots\dots\dots$ [1]

Method 2.

- (b) The student measures the mass M of the rule, using a spring balance as shown in Fig. 1.2.

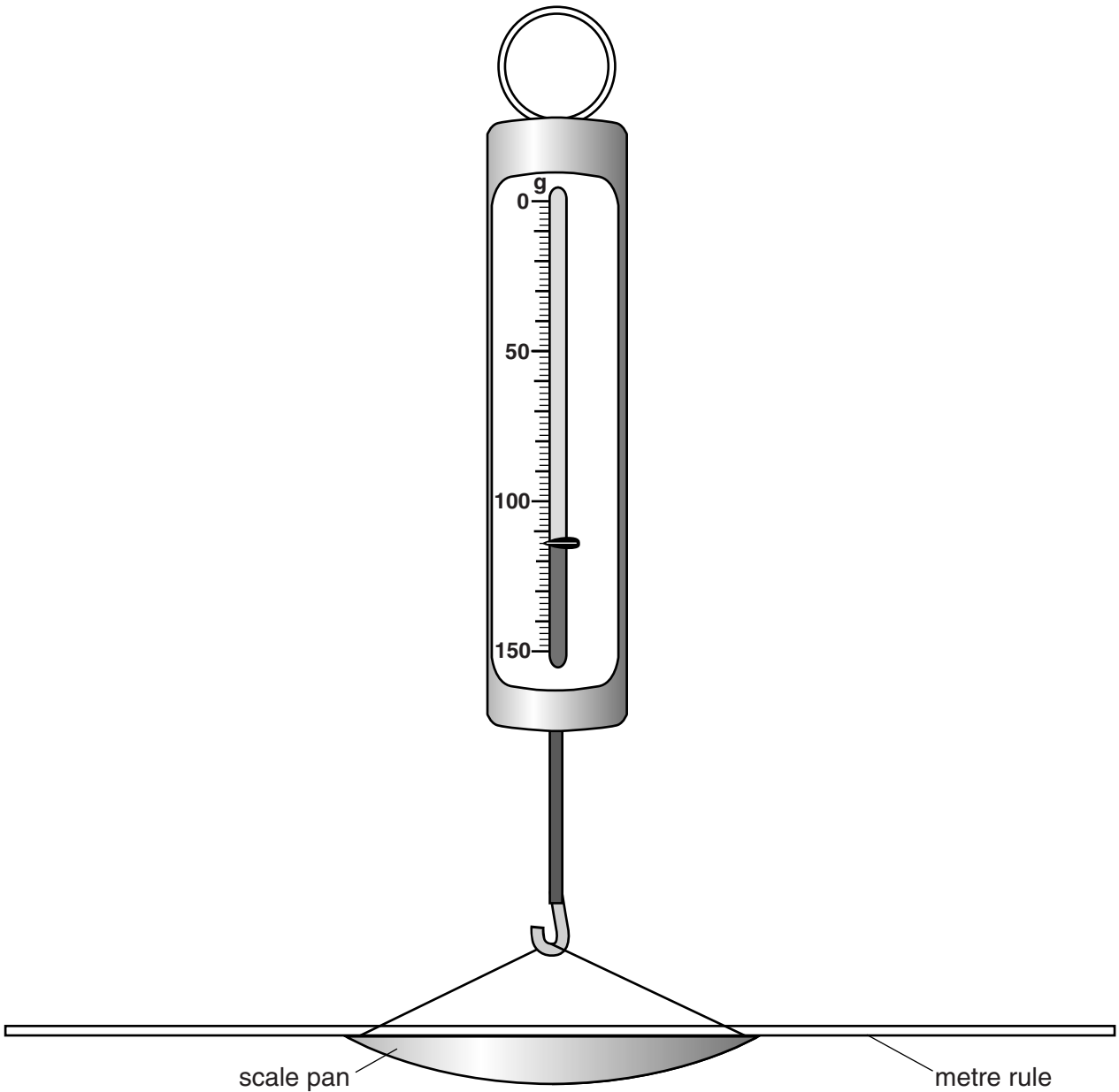

Fig. 1.2

Write down the reading shown in Fig. 1.2.

$M = \dots\dots\dots$ [1]

- (c) The student expects that the values of the mass M obtained by the two methods are exactly the same.

Suggest two practical reasons why, in spite of following the instructions with care, the values may differ. Assume that the balance used in Method 2 is accurate.

- 1.
.....
- 2.
.....

[2]

- (d) Explain briefly how you would judge the position of the centre of the mass X when it is on the rule in Method 1. You may draw a diagram.

.....
.....
.....

[1]

[Total: 7]

2 The IGCSE class is investigating the cooling of water.

(a) A student places a thermometer in a beaker of cold water.

Using Fig. 2.1, record the temperature θ_C of the cold water supplied to the student.

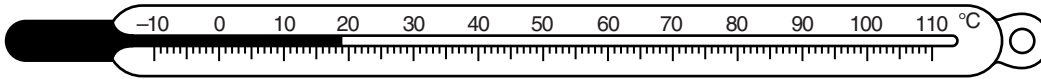

Fig. 2.1

$\theta_C = \dots\dots\dots$ [1]

(b) The student pours 200 cm³ of hot water into a beaker. She measures the temperature of the water at 30 s intervals. The readings are shown in Table 2.1.

Table 2.1

$t/$	$\theta/$
0	80
30	75
60	72
90	69
120	67
150	66

Complete the column headings in the table. [1]

(c) The student empties the beaker and pours another 200 cm³ of the hot water into the beaker. She measures the temperature θ_H of the water in the beaker.

$\theta_H = \dots\dots\dots 78^\circ\text{C}$

She then empties the cold water from the measuring cylinder shown in Fig. 2.2 into the beaker of hot water. She measures the temperature θ_A of the water in the beaker.

$\theta_A = \dots\dots\dots 74^\circ\text{C}$

Using Fig. 2.2, record the volume V_A of cold water.

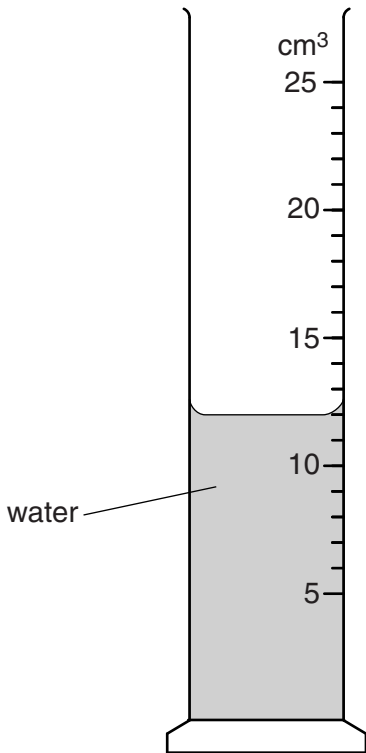

Fig. 2.2

$V_A = \dots\dots\dots$ [1]

- (d) Estimate the volume V of cold water that, added to the hot water, would give the same temperature drop as allowing the hot water to cool for 150s.

Use the evidence from the table and the readings in parts (b) and (c). Explain briefly how you arrived at your answer.

.....

.....

.....

$V = \dots\dots\dots$ [2]

- (e) This laboratory investigation could be used as a small-scale model for a process in a factory. The laboratory investigation would be repeated many times.

Suggest two conditions that should be kept constant in order to provide reliable results.

1.

2.

[2]

[Total: 7]

3 The IGCSE class is investigating resistor combinations in circuits.

The first circuit used is shown in Fig. 3.1.

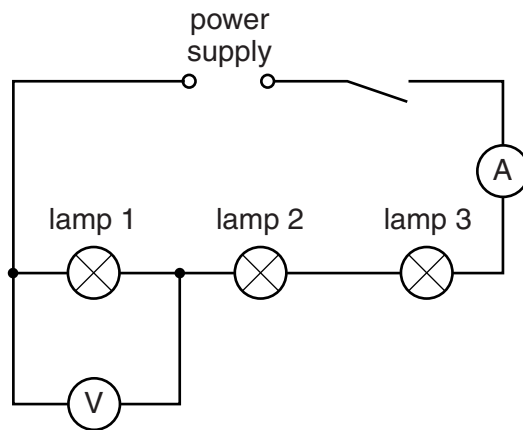

Fig. 3.1

A student measures the potential difference V_1 across lamp 1 and the current I in the circuit.

(a) (i) Using Fig. 3.2, record the student's readings.

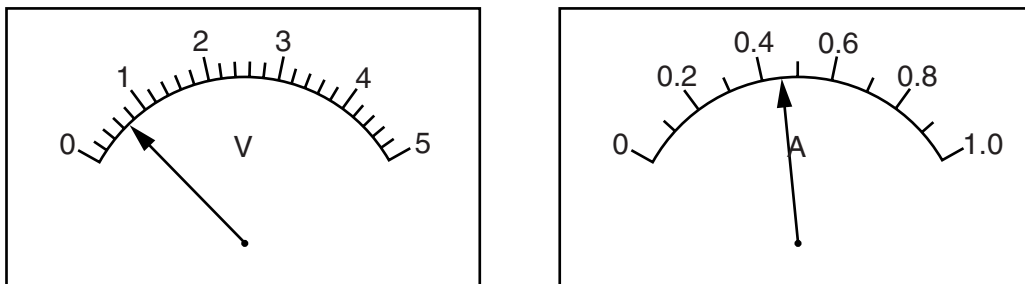

Fig. 3.2

$V_1 =$

$I =$

[2]

(ii) Calculate the resistance R_1 of lamp 1 using the equation $R_1 = \frac{V_1}{I}$.

$R_1 =$ [1]

(b) The student uses the voltmeter to measure the potential difference V_2 across lamp 2 and the potential difference V_3 across lamp 3.

(i) Using Fig. 3.3, record the student's reading of V_2 .

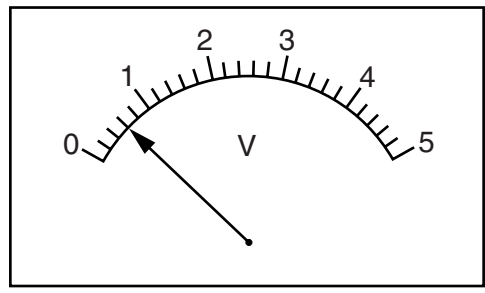

Fig. 3.3

$V_2 = \dots\dots\dots$

(ii) Using Fig. 3.4, record the student's reading of V_3 .

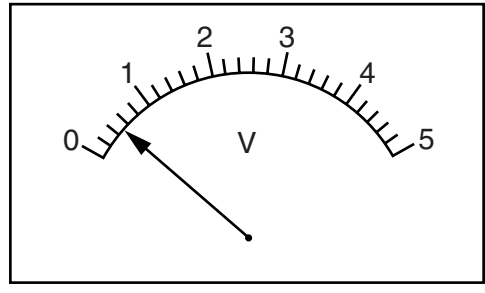

Fig. 3.4

$V_3 = \dots\dots\dots$
[1]

(c) Calculate the total potential difference V_T across the three lamps using the equation $V_T = V_1 + V_2 + V_3$.

$V_T = \dots\dots\dots$ [1]

- (d) The student rearranges the circuit so that the lamps are in parallel with each other and the ammeter is connected to measure the total current I_T in the circuit.

He connects the voltmeter to measure the potential difference V_p across the lamps.

In the space below, draw a circuit diagram of this new circuit using standard symbols.

[2]

- (e) The student measures the potential difference V_p and the current I_T , and calculates the total resistance R_p of the lamps arranged in parallel.

$$R_p = \dots\dots\dots 2.1 \Omega$$

The student suggests that R_p should be equal to $\frac{R_1}{3}$.

State whether the results support this suggestion and justify your answer by reference to the results.

statement

justification

.....

[1]

- (f) Another student suggests that R_p should not be equal to $\frac{R_1}{3}$ because the lamp filaments are hotter when the lamps are connected in parallel than when the lamps are connected in series.

State one piece of evidence, that you would see during the investigation, that shows that the lamp filaments are hotter in the parallel circuit.

.....

..... [1]

[Total: 9]

- 4 A student carries out an experiment using a simple pendulum.

Fig. 4.1 shows the apparatus.

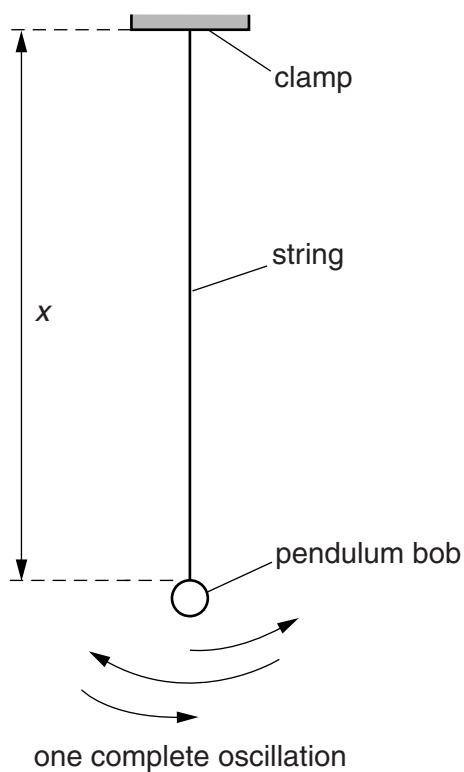

Fig. 4.1

The student records the time t taken for 20 complete oscillations of the pendulum for a range of different lengths x of the string. The readings are shown in Table 4.1.

Table 4.1

x/cm	t/s	T/s
90.0	38.5	
80.0	36.0	
70.0	33.4	
60.0	31.4	
50.0	28.2	
40.0	25.5	

- (a) The period T of the pendulum is the time taken for one complete oscillation.

For each set of readings in the table, calculate the period T and enter the results in the table. [2]

(b) Suggest a reason for measuring the time for twenty oscillations rather than just one.
.....
.....
.....[1]

(c) In this experiment, the length x of the string is measured with a metre rule.
Suggest one precaution that you would take when measuring the length in order to obtain an accurate reading.
.....
.....[1]

(d) The student decides that a more useful result is possible if the length is measured to the centre of mass of the pendulum bob.
The pendulum bob is a small metal ball. The student has a 30cm ruler and two rectangular blocks of wood that are about 10cm long.
Suggest how the student can use this equipment to measure accurately the diameter of the pendulum bob. You may draw a diagram.
.....
.....
.....[2]

[Total: 6]

- 5 The IGCSE class is determining the focal length of a lens.

The apparatus is shown in Fig. 5.1.

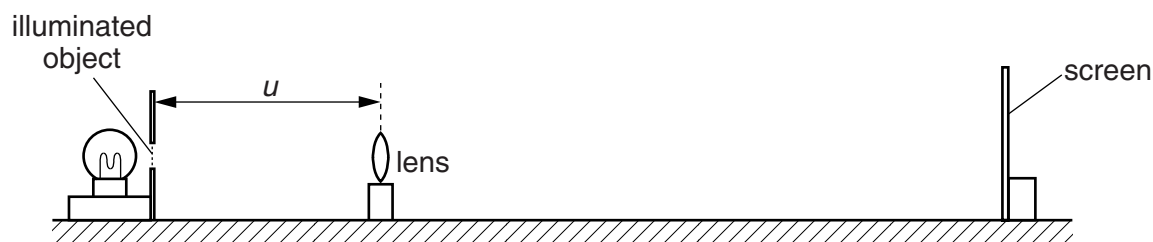

Fig. 5.1

A student places the lens a distance $u = 25.0$ cm from an illuminated object of height 1.5 cm. She moves the screen until a sharply focused image of the object is seen on the screen.

She measures the height h of the image on the screen. She calculates $\frac{1}{h}$.

She repeats the procedure using a range of u values. Her results are shown in Table 5.1.

Table 5.1

u/cm	h/cm	$\frac{1}{h} / \frac{1}{\text{cm}}$
25.0	2.2	0.45
30.0	1.5	0.67
35.0	1.1	0.91
40.0	0.9	1.1
45.0	0.8	1.3

(a) Plot a graph of u/cm (y -axis) against $\frac{1}{h} / \frac{1}{\text{cm}}$ (x -axis). You do not need to begin the graph at the origin (0,0).

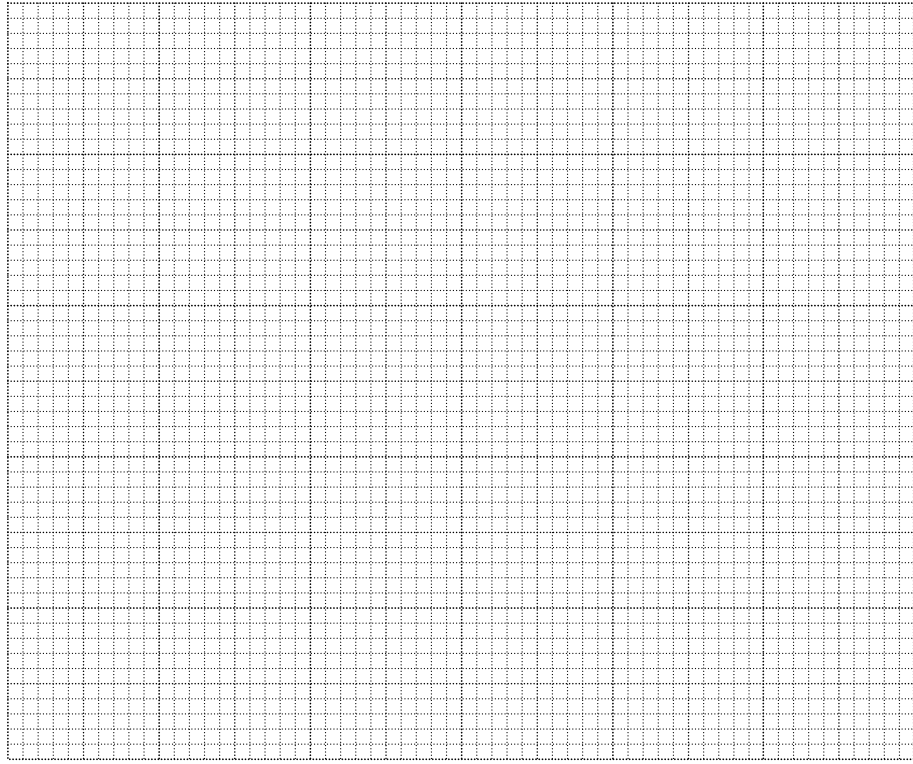

[5]

(b) Determine the gradient G of the graph. Show clearly on the graph how you obtained the necessary information.

$G = \dots\dots\dots$ [2]

(c) Calculate the focal length f of the lens, using the equation $f = \frac{G}{1.5}$ cm. Give your answer to a suitable number of significant figures for this experiment.

$f = \dots\dots\dots$ [2]

(d) State two precautions that you would take in this experiment in order to obtain accurate results.

- 1.
-
- 2.
-

[2]

[Total: 11]

Permission to reproduce items where third-party owned material protected by copyright is included has been sought and cleared where possible. Every reasonable effort has been made by the publisher (UCLES) to trace copyright holders, but if any items requiring clearance have unwittingly been included, the publisher will be pleased to make amends at the earliest possible opportunity.

University of Cambridge International Examinations is part of the Cambridge Assessment Group. Cambridge Assessment is the brand name of University of Cambridge Local Examinations Syndicate (UCLES), which is itself a department of the University of Cambridge.