

Physics
Higher level
Paper 1

Friday 8 May 2015 (morning)

1 hour

Instructions to candidates

- Do not open this examination paper until instructed to do so.
- Answer all the questions.
- For each question, choose the answer you consider to be the best and indicate your choice on the answer sheet provided.
- A clean copy of the **physics data booklet** is required for this paper.
- The maximum mark for this examination paper is **[40 marks]**.

1. Which of the following expresses the ratio $\frac{\text{mass of a proton}}{\text{mass of a electron}}$ as a difference in orders of magnitude?
- A. –3
B. 0
C. 3
D. 6
2. A body moves in a straight line. In order for the equations for uniformly accelerated motion to be applied, which condition **must** be true?
- A. A constant net force acts on the body of fixed mass.
B. A constant net force acts on the body.
C. The body falls towards the surface of a planet.
D. The body has an initial velocity of zero.
3. The graph shows the variation with time of the velocity of a truck of fixed mass.

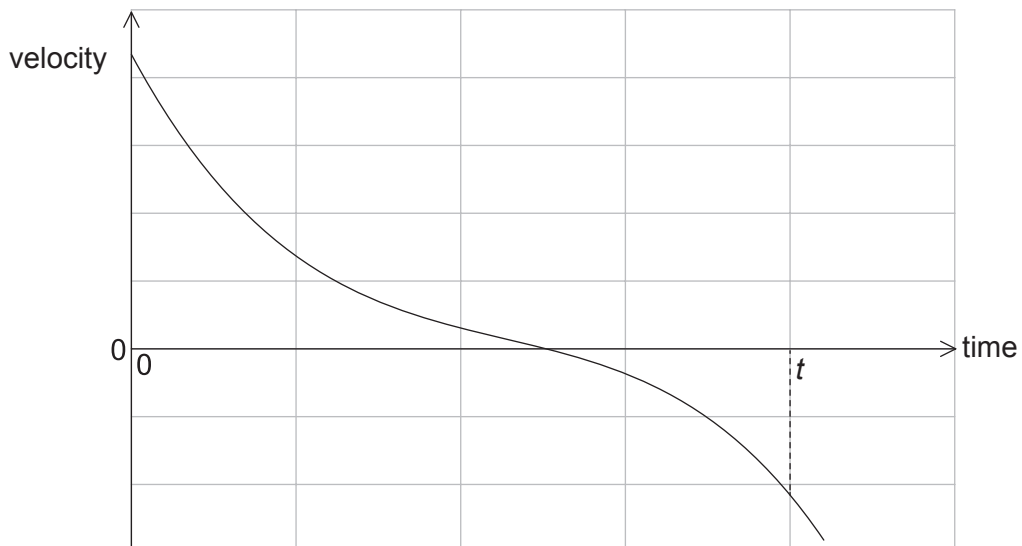

What can be deduced from the graph?

- A. The truck is always accelerating.
B. The truck is always moving.
C. The truck is always moving in one direction.
D. The displacement of the truck after time t is zero.

4. A girl is standing on a moving skateboard. She pushes backwards on the ground at intervals as shown on the graph.

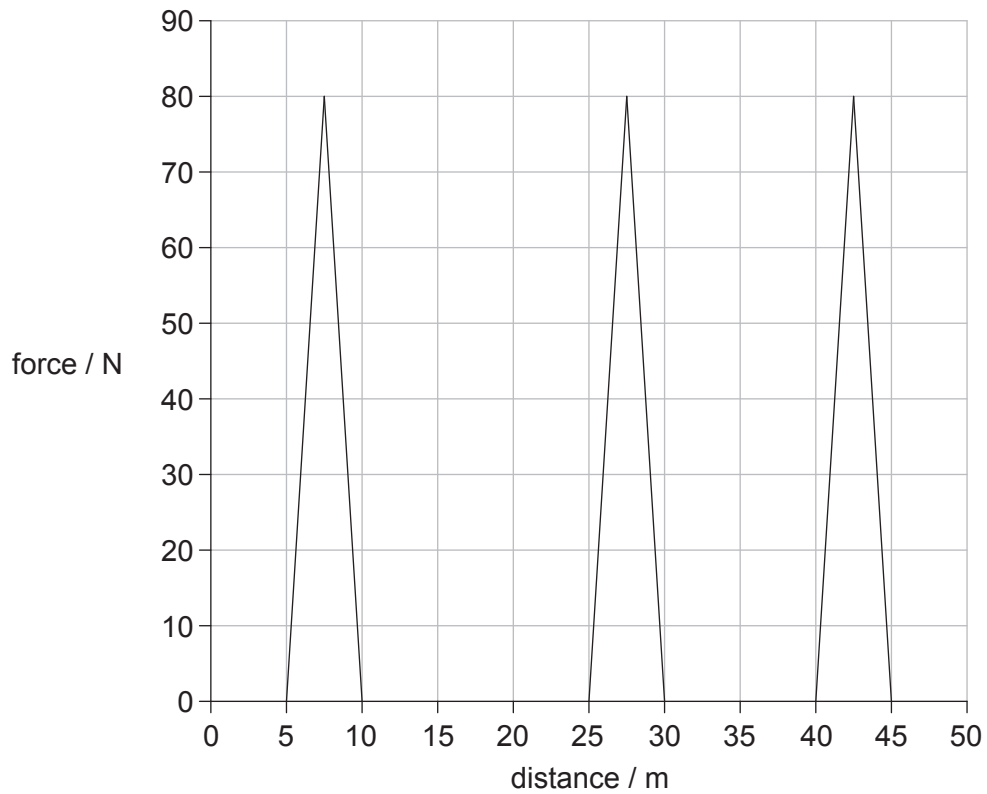

How much kinetic energy is gained by the girl during the period represented on the graph?
Frictional forces are negligible.

- A. 200 J
- B. 400 J
- C. 600 J
- D. 1200 J

5. An electron moves with uniform circular motion in a region of magnetic field. Which diagram shows the acceleration a and velocity v of the electron at point P?

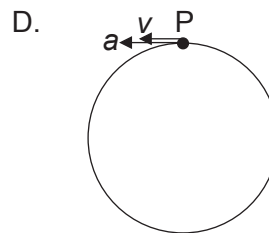
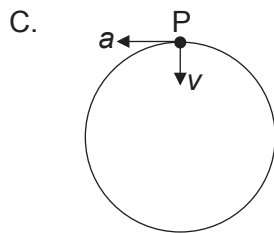
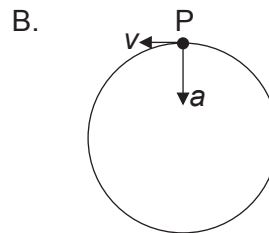
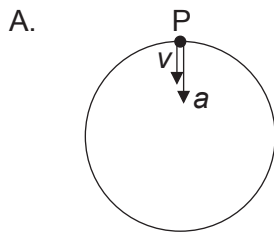

6. Equal masses of water at 80°C and paraffin at 20°C are mixed in a container of negligible thermal capacity. The specific heat capacity of water is twice that of paraffin. What is the final temperature of the mixture?

- A. 30°C
 B. 40°C
 C. 50°C
 D. 60°C

7. Which of the following is an assumption of the kinetic model of an ideal gas?

- A. The gas is at high pressure.
 B. There are weak forces of attraction between the particles in the gas.
 C. The collisions between the particles are elastic.
 D. The energy of the particles is proportional to the absolute temperature.

8. An ideal gas undergoes adiabatic expansion from state X to a new state of volume V . During this process the work done by the gas is W . What is the change in internal energy and the work done in an **isothermal** expansion of this gas from X to V ?

	Change in internal energy	Work done
A.	0	greater than W
B.	0	less than W
C.	greater than 0	less than W
D.	less than 0	same as W

9. A block of ice at 0°C is placed on a surface and allowed to melt completely to give water at 0°C . During this process the entropy of the
- molecules in the block has decreased.
 - surroundings has increased.
 - universe has increased.
 - universe has decreased.
10. A liquid in a U-tube is given an initial displacement and allowed to oscillate. The motion of the liquid is recorded using a motion sensor. Which graph shows the variation with time t of the velocity v of the liquid?

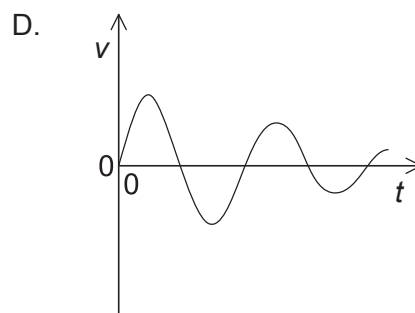
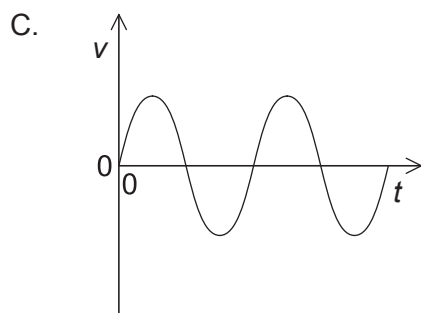
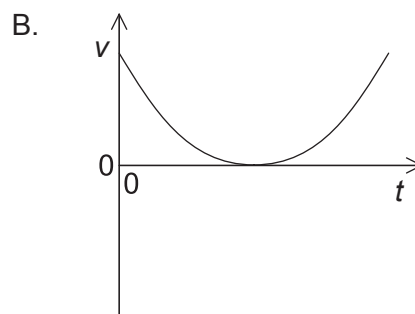
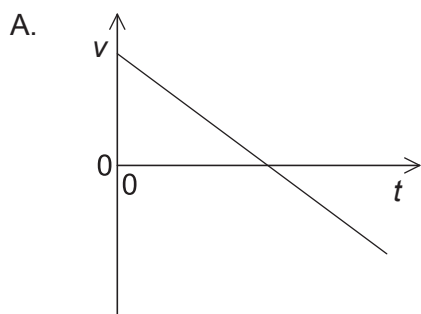

11. The bob of a pendulum has an initial displacement x_0 to the right. The bob is released and allowed to oscillate. The graph shows how the displacement varies with time. At which point is the velocity of the bob at maximum towards the right?

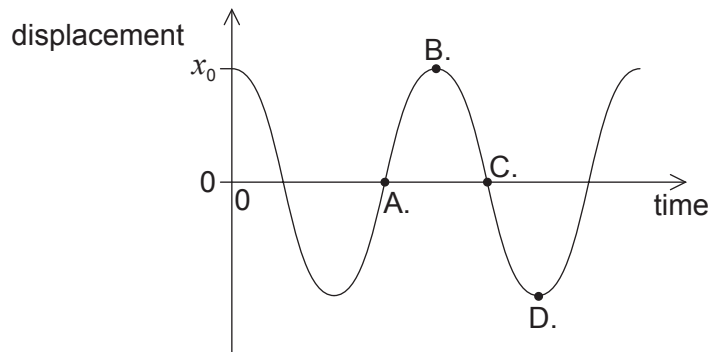

12. A wave pulse is sent along a light string which is attached to a heavy rope as shown. The diagrams are not to scale.



Which diagram shows the shape of the string and the rope after a short time?

- A.
- B.
- C.
- D.

13. A standing (stationary) sound wave is set up inside a narrow glass tube which has both ends open. The fundamental (first harmonic) frequency of the standing wave is 500 Hz. What is the fundamental frequency of the sound wave if the length of the tube is halved and one end is closed?
- A. 250 Hz
- B. 500 Hz
- C. 1000 Hz
- D. 2000 Hz

14. An object emitting a sound of frequency 100 Hz orbits in a horizontal circle at a rate of two revolutions per second.

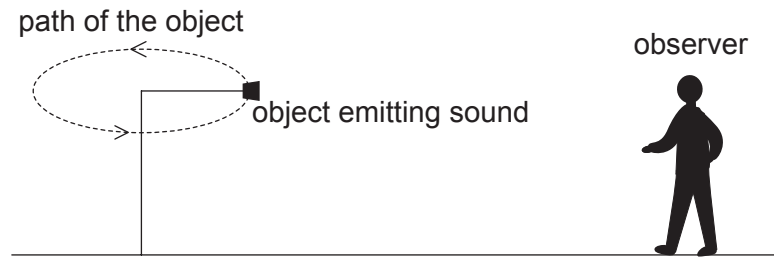

An observer standing a short distance away from the object is able to hear the sound. Which of the following describes the sound the observer is able to hear?

- A. A sound of constant frequency but varying in amplitude
 - B. A sound of constantly varying frequency
 - C. A sound with a frequency of 50 Hz
 - D. A sound with a frequency of 200 Hz
15. Green light is emitted by two point sources. The light passes through a narrow slit and is received by an observer. The images of the two sources just fail to be resolved. Which change allows for the images to be resolved?
- A. Replacing the narrow slit with a circular aperture of same size.
 - B. Moving the two sources further from the aperture.
 - C. Using red light.
 - D. Using violet light.

16. Two cylindrical copper wires, W_1 and W_2 , are held at the same temperature. W_2 is twice as long and has half the diameter of W_1 .

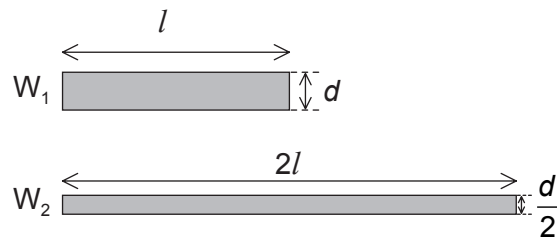

What is the ratio $\frac{\text{resistance of } W_2}{\text{resistance of } W_1}$?

- A. 1
- B. 2
- C. 4
- D. 8

17. The diagram shows an electric circuit containing a potentiometer of maximum resistance R . The potentiometer is connected in series with a resistor also of resistance R . The electromotive force (emf) of the battery is 6V and its internal resistance is negligible.

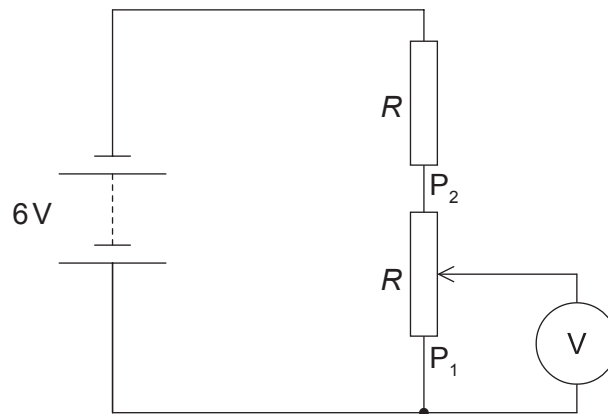

The slider on the potentiometer is moved from P_1 to P_2 . Which graph shows the variation of the voltmeter V reading with slider distance d ?

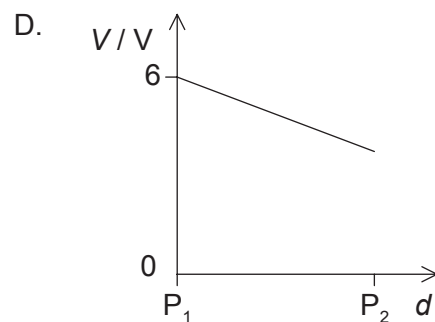
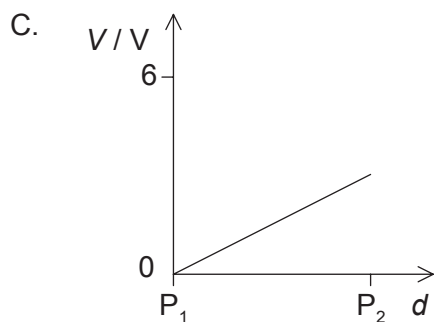
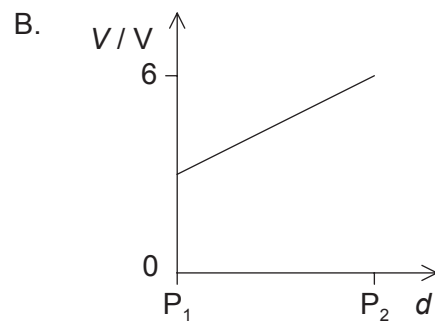
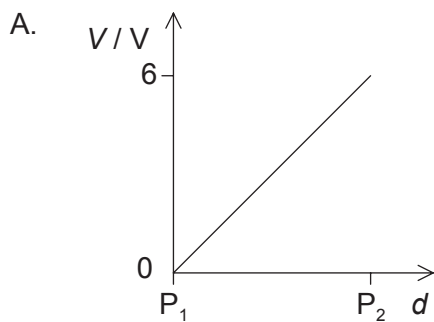

18. A magnet oscillates above a solenoid as shown.

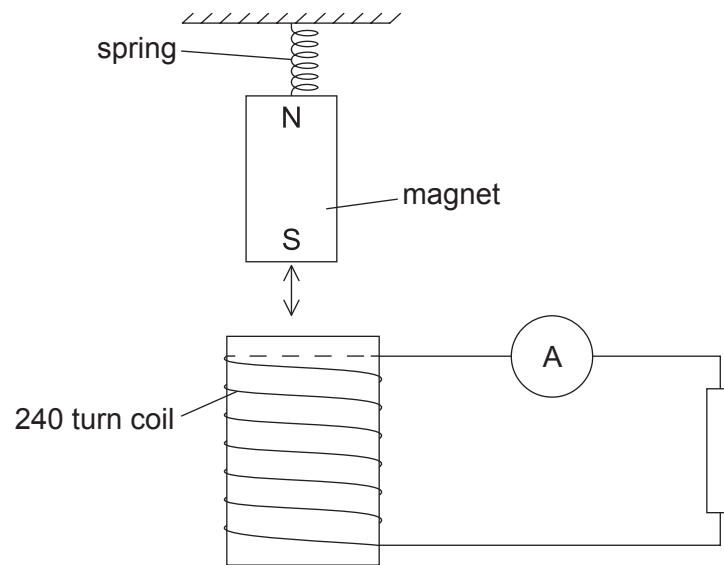

The magnet is displaced vertically and released from its highest position at time $t=0$. Which graph shows the variation with time t of the current I in the resistor?

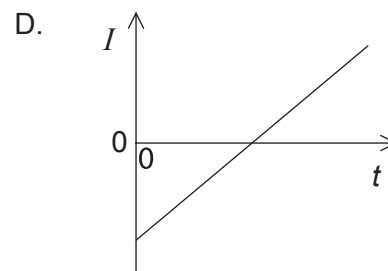
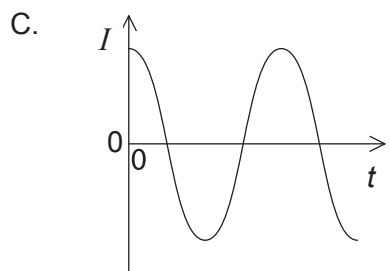
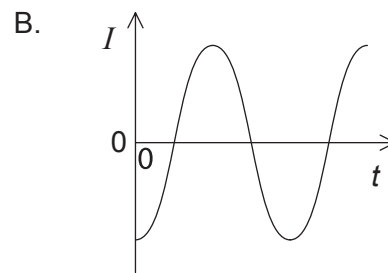
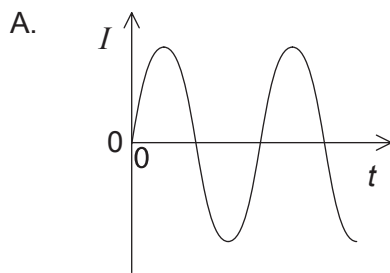

19. Two identical resistors R are connected in series to an alternating current (ac) power supply. The power supply has a root mean squared (rms) voltage of V and an rms current of I . What is the maximum power developed in **one** of the resistors in the circuit?

- A. $\sqrt{2}VI$
 B. VI
 C. $2VI$
 D. $\frac{VI}{\sqrt{2}}$

20. The diagram shows two point charges P and Q. At which position is the electric field strength equal to zero?

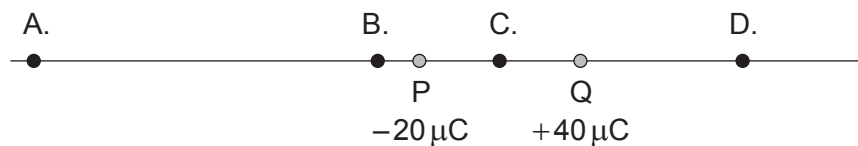

21. An electron is held close to the surface of a negatively charged sphere and then released. Which describes the velocity and the acceleration of the electron after it is released?

	Velocity	Acceleration
A.	decreasing	constant
B.	decreasing	decreasing
C.	increasing	constant
D.	increasing	decreasing

22. A long, straight, current-carrying wire is placed between a pair of magnets as shown. What is the direction of the force on the wire?

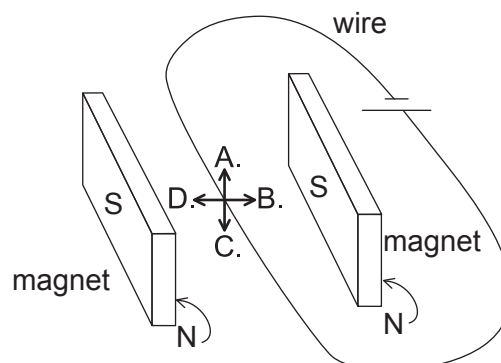

23. The horizontal component v_h and the vertical component v_v of velocity of an object are shown on the graphs. Air resistance is negligible.

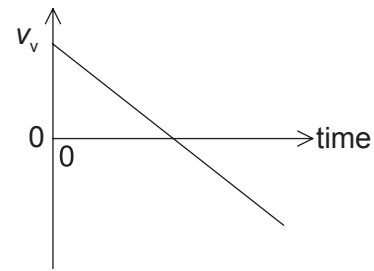
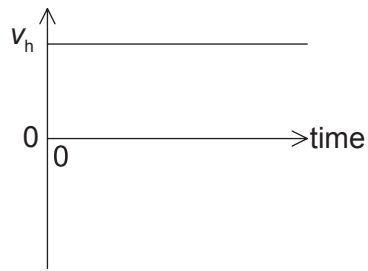

These graphs could represent the motion of an object fired from a cliff

- A. vertically upwards.
 B. at an angle above the horizontal.
 C. horizontally.
 D. at an angle below the horizontal.
24. Two spherical objects of mass M are held a small distance apart. The radius of each object is r .

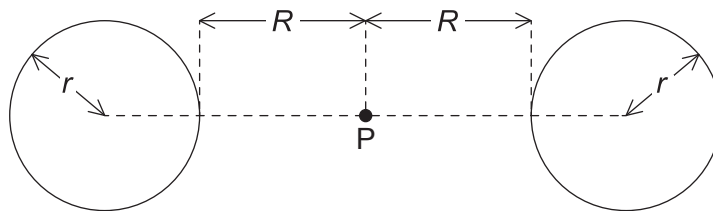

Point P is the midpoint between the objects and is a distance R from the surface of each object. What is the gravitational potential at point P?

- A. $-\frac{GM}{(r+R)^2}$
 B. $-2\frac{GM}{r+R}$
 C. $-\frac{GM}{r+R}$
 D. 0

25. The diagram shows equipotential lines around two sources.

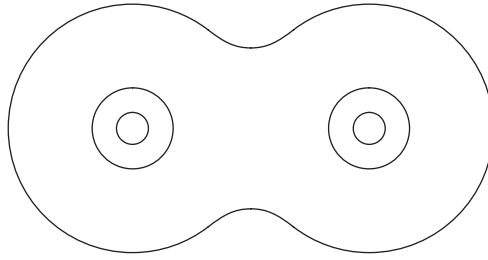

Possible sources are

- I. two equal masses
- II. two equal charges of same sign
- III. two equal charges of opposite sign.

What is/are the possible source(s) for the equipotential lines?

- A. I and II only
- B. I and III only
- C. II only
- D. III only

26. The structure of the atom was investigated by firing alpha particles from a source at a thin foil of gold. The basic set-up of the apparatus is shown.

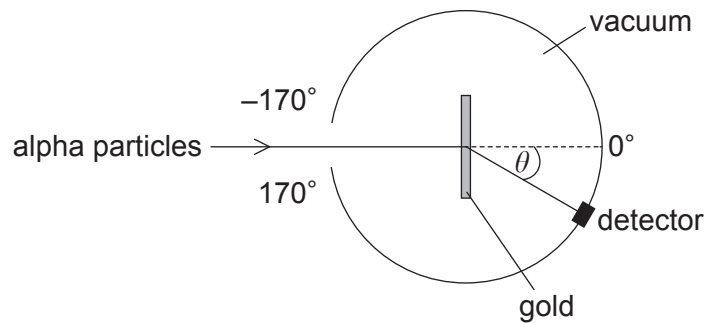

Which graph shows the variation in the number of scattered alpha particles with scattering angle θ ?

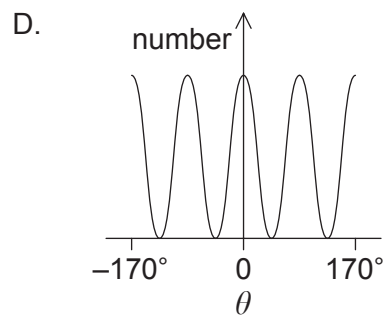
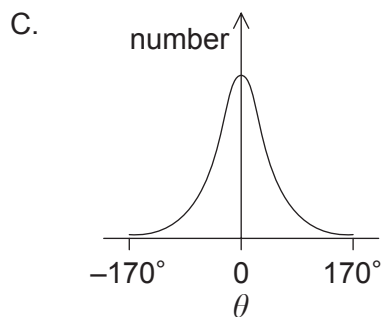
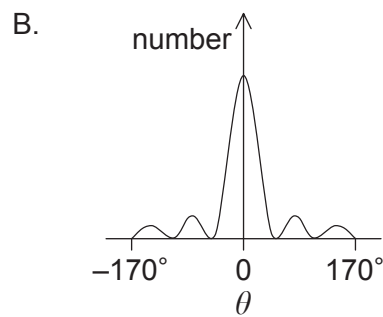
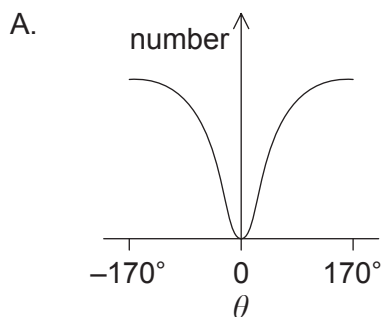

27. Which of the following shows an example of artificial (induced) transmutation?

- A. $\text{Am} \rightarrow \text{Np} + \alpha$
 B. $\text{Al} + \alpha \rightarrow \text{P} + \text{n}$
 C. $\text{C} \rightarrow \text{B} + \text{e} + \bar{\nu}$
 D. $\text{n} \rightarrow \text{p} + \text{e} + \bar{\nu}$

28. Red light incident on a metal surface produces photoelectrons.

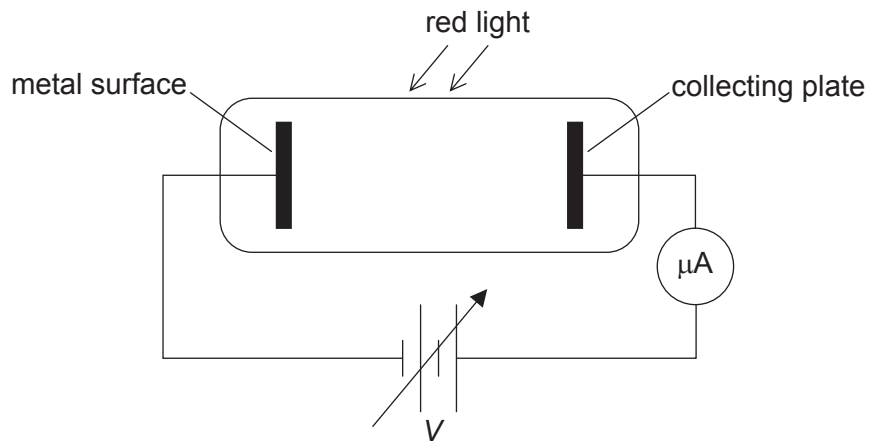

The potential V of the supply is varied and the current is measured. The results are shown on the graph.

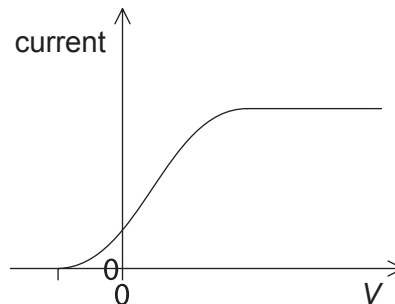

The light source is changed to blue. This blue source emits the same number of photons per second as the red source. Which graph shows the variation with potential of current for blue light? The results for the red light are shown as a dashed line.

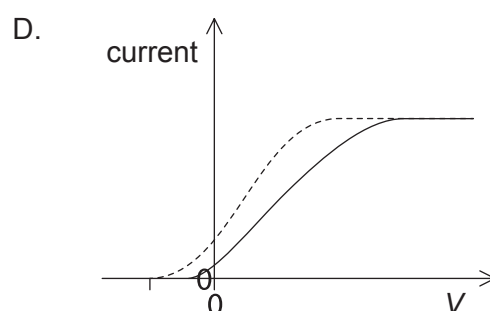
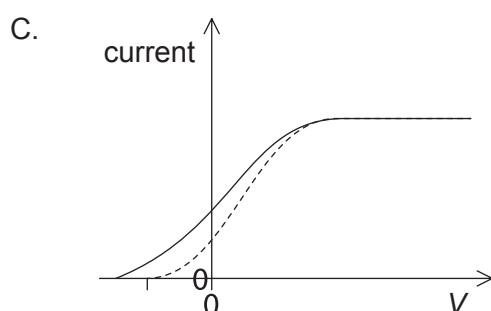
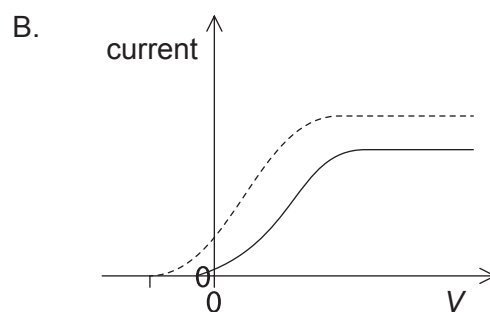
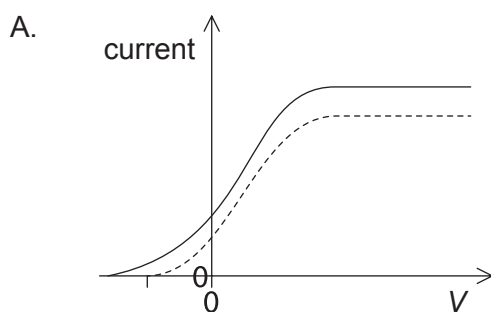

29. An electron accelerated through a potential V has a de Broglie wavelength of λ . What will be the de Broglie wavelength when the electron is accelerated through a potential of $4V$?
- A. $\frac{\lambda}{4}$
- B. $\frac{\lambda}{2}$
- C. 2λ
- D. 4λ
30. According to the “electron in a box” model, what is **not** a permitted value for the momentum of an electron moving in a box of length L ?
- A. $\frac{2h}{L}$
- B. $\frac{h}{L}$
- C. $\frac{h}{2L}$
- D. $\frac{h}{4L}$
31. A small particle with mass m and charge $+q$ enters a mass spectrometer at a speed v . The magnetic field strength inside the mass spectrometer is B . The particle moves in a uniform circle with radius r . A second particle also moves inside the mass spectrometer. This second particle moves with the same radius r . Which of the following conditions applies to this situation?

	Mass	Charge	Speed
A.	m	$2q$	$\frac{v}{2}$
B.	$2m$	$2q$	v
C.	$2m$	q	$\frac{v}{2}$
D.	$2m$	$2q$	$\frac{v}{2}$

32. The following observations are made during nuclear decays.

- I. Discrete energy of alpha particles
- II. Continuous energy of beta particles
- III. Discrete energy of gamma rays

Which of the observations provide evidence of the existence of nuclear energy levels?

- A. I only
 - B. II only
 - C. I and III only
 - D. I, II and III
33. What is the approximate percentage of the world's energy needs that are provided by renewable energy sources?
- A. 10 %
 - B. 30 %
 - C. 50 %
 - D. 70 %
34. An ocean-wave energy converter is located in a region where the average wave amplitude is A and the wave speed is v . The average power output of this converter is P .

What is the average power output of this converter when the wave amplitude is $\frac{A}{2}$ and the wave speed is $2v$?

- A. $\frac{P}{2}$
- B. P
- C. $2P$
- D. $4P$

35. Which of the following lists snow, desert and ocean in increasing order of magnitude of albedo?

	Lowest albedo	—————>	Highest albedo
A.	snow	desert	ocean
B.	snow	ocean	desert
C.	ocean	desert	snow
D.	desert	ocean	snow

36. The graph shows the variation with wavelength of intensity of radiation emitted by two bodies X and Y. X and Y have the same surface area.

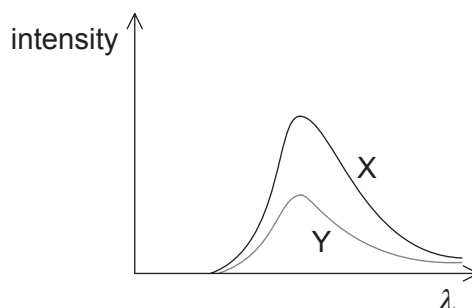

How do the temperature and the emissivity of X compare with the temperature and the emissivity of Y?

	Temperature	Emissivity
A.	different	different
B.	equal	different
C.	different	equal
D.	equal	equal

37. Methane and carbon dioxide are both greenhouse gases that are believed to cause global warming. The reason for this is that these gases
- absorb incoming radiation from the Sun.
 - transmit the incoming radiation from the Sun and radiation from the Earth.
 - reflect incoming radiation from the Sun.
 - transmit incoming radiation from the Sun and absorb outgoing radiation from the Earth.

38. How many different states can be represented by a 4-bit binary number?
- A. 4
 - B. 8
 - C. 15
 - D. 16
39. Which of the following expresses the units of capacitance in terms of fundamental units?
- A. $\text{s}^4 \text{A}^2 \text{m}^{-2} \text{kg}^{-1}$
 - B. $\text{s}^2 \text{A m}^{-2} \text{kg}^{-1}$
 - C. $\text{s}^4 \text{A}^2 \text{m}^{-2}$
 - D. $\text{s}^2 \text{A m}^{-2}$
40. N photons are incident onto a pixel of a charge-coupled device (CCD). The CCD has a quantum efficiency of η . The capacitance of one pixel is C . What will be the potential difference across the pixel?
- A. $\frac{\eta Ne}{C}$
 - B. $\frac{NeC}{\eta}$
 - C. $\frac{Ne}{\eta C}$
 - D. $\frac{\eta N}{eC}$
-