

Physics
Standard level
Paper 1

Friday 8 May 2015 (morning)

45 minutes

Instructions to candidates

- Do not open this examination paper until instructed to do so.
- Answer all the questions.
- For each question, choose the answer you consider to be the best and indicate your choice on the answer sheet provided.
- A clean copy of the **physics data booklet** is required for this paper.
- The maximum mark for this examination paper is **[30 marks]**.

1. Which of the following expresses the watt in terms of fundamental units?
- A. kgm^2s
- B. $\text{kgm}^2\text{s}^{-1}$
- C. $\text{kgm}^2\text{s}^{-2}$
- D. $\text{kgm}^2\text{s}^{-3}$
2. The graph shows a set of experimental results to determine the density of oil. The results have systematic errors and random errors.

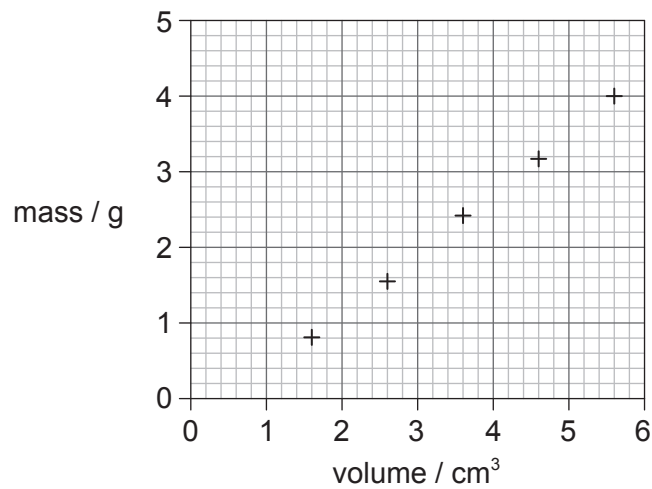

Using the information on the graph, what can be said about the measurements used to find the density of oil?

	Systematic errors	Random errors
A.	small	small
B.	small	large
C.	large	small
D.	large	large

3. A body moves in a straight line. In order for the equations for uniformly accelerated motion to be applied, which condition **must** be true?
- A. A constant net force acts on the body of fixed mass.
 - B. A constant net force acts on the body.
 - C. The body falls towards the surface of a planet.
 - D. The body has an initial velocity of zero.
4. The graph shows the variation with time of the velocity of a truck of fixed mass.

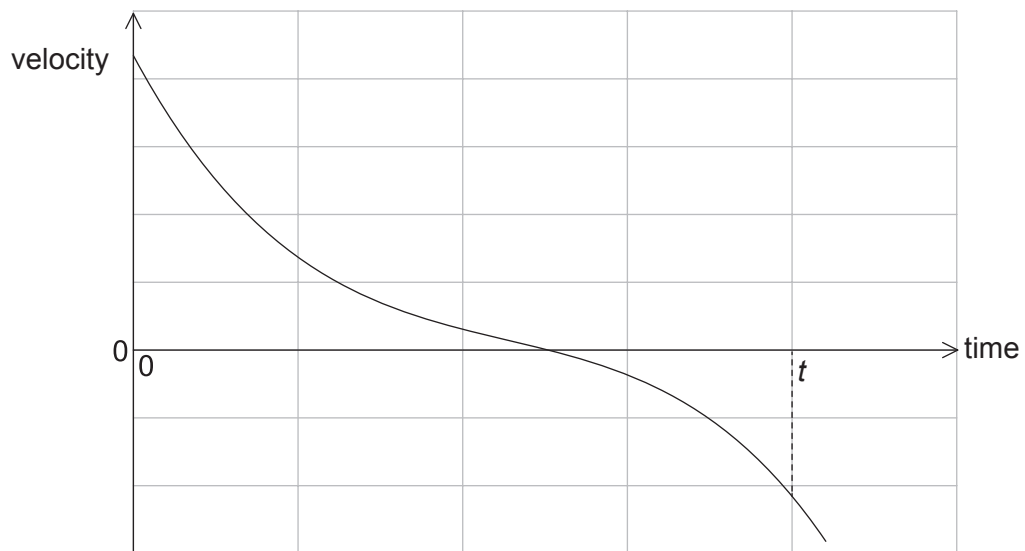

What can be deduced from the graph?

- A. The truck is always accelerating.
- B. The truck is always moving.
- C. The truck is always moving in one direction.
- D. The displacement of the truck after time t is zero.

5. A student of mass m is in an elevator which is accelerating downwards at an acceleration a .

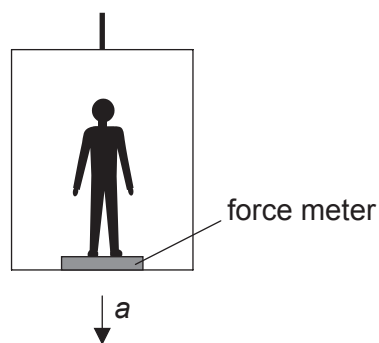

What is the reading on the force meter?

- A. mg
 B. $mg - ma$
 C. $mg + ma$
 D. $ma - mg$
6. An electric motor is used to lift a heavy load. The Sankey diagram shows the energy transformations involved in the process.

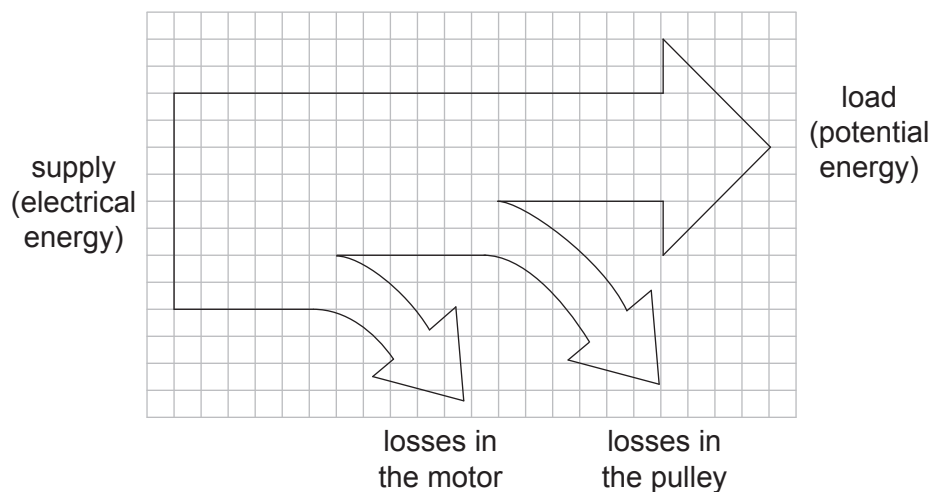

What is the efficiency of the motor?

- A. 33 %
 B. 50 %
 C. 67 %
 D. 75 %

7. An electron moves with uniform circular motion in a region of magnetic field. Which diagram shows the acceleration a and velocity v of the electron at point P?

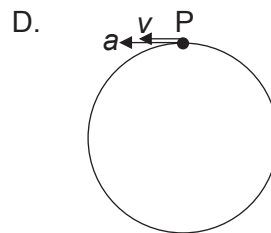
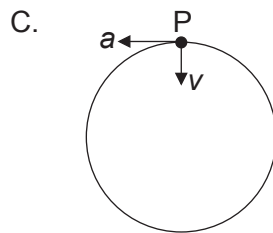
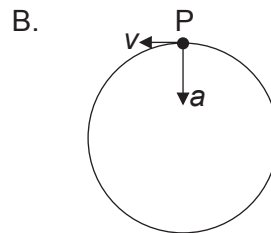
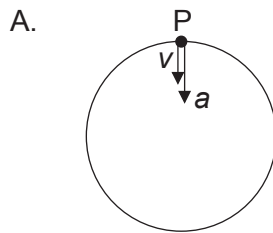

8. Which of the following is equivalent to a temperature of -100°C ?

- A. -373K
B. -173K
C. 173K
D. 373K

9. A sample of solid copper is heated beyond its melting point. The graph shows the variation of temperature with time.

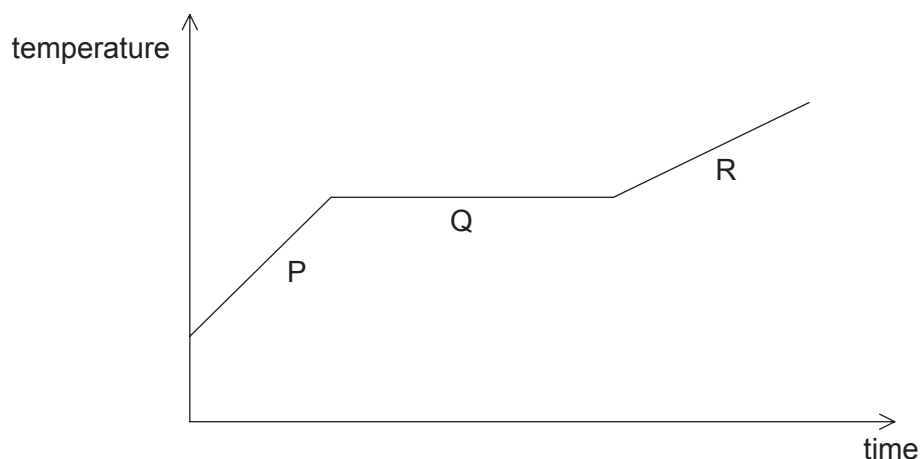

During which stage(s) is/are there an increase in the internal energy of the copper?

- A. P, Q and R
- B. Q only
- C. P and R only
- D. Q and R only
10. Equal masses of water at 80°C and paraffin at 20°C are mixed in a container of negligible thermal capacity. The specific heat capacity of water is twice that of paraffin. What is the final temperature of the mixture?
- A. 30°C
- B. 40°C
- C. 50°C
- D. 60°C
11. Which of the following is an assumption of the kinetic model of an ideal gas?
- A. The gas is at high pressure.
- B. There are weak forces of attraction between the particles in the gas.
- C. The collisions between the particles are elastic.
- D. The energy of the particles is proportional to the absolute temperature.

12. The bob of a pendulum has an initial displacement x_0 to the right. The bob is released and allowed to oscillate. The graph shows how the displacement varies with time. At which point is the velocity of the bob at maximum towards the right?

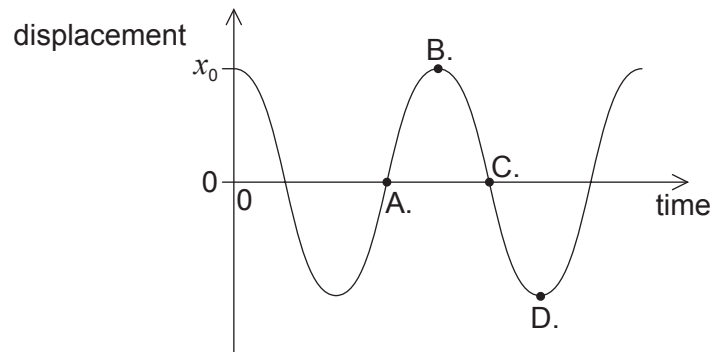

13. The effects of resonance should be avoided in
- A. quartz oscillators.
 - B. vibrations in machinery.
 - C. microwave generators.
 - D. musical instruments.

14. A water wave entering a harbour passes suddenly from deep to shallow water. In deep water, the wave has frequency f_1 and speed v_1 . In shallow water, the wave has frequency f_2 and speed v_2 .

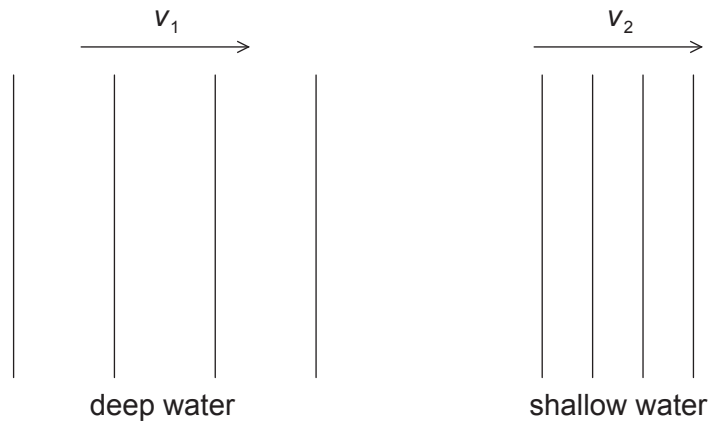

Which of the following compares the frequencies and speeds of the wave between deep water and shallow water?

	Frequencies	Wave speeds
A.	$f_1 = f_2$	$v_1 > v_2$
B.	$f_1 = f_2$	$v_1 < v_2$
C.	$f_1 > f_2$	$v_1 = v_2$
D.	$f_1 < f_2$	$v_1 > v_2$

15. Two wave pulses move towards each other as shown in the diagram.

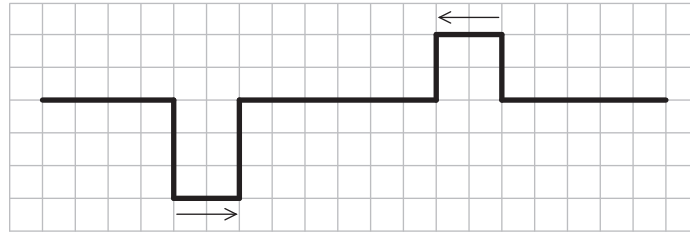

Which diagram shows a possible combination of the two pulses after a short time?

A.

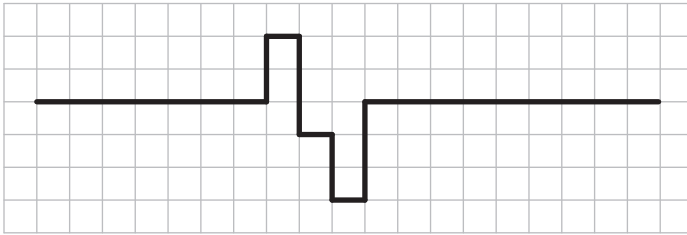

B.

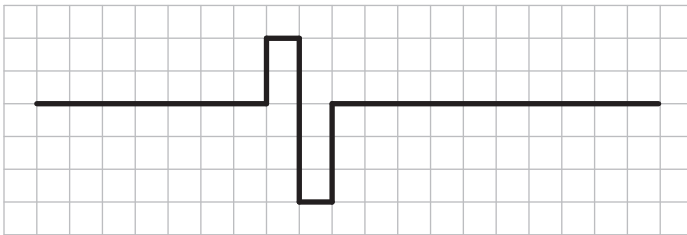

C.

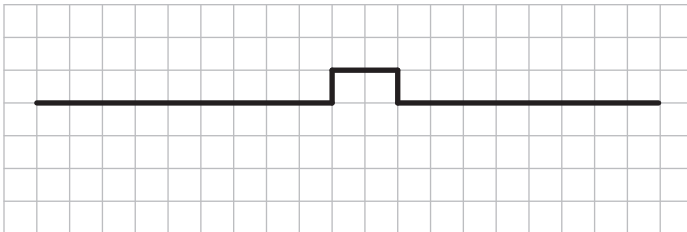

D.

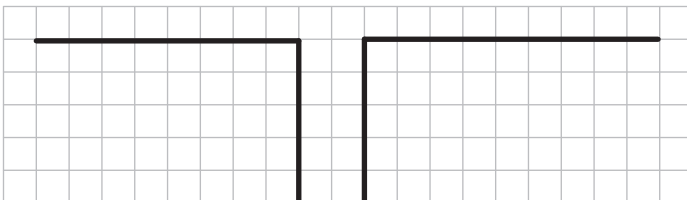

16. What is the definition of electric current?
- A. The ratio of potential difference across a component to the resistance of the component
 - B. The power delivered by a battery per unit potential difference
 - C. The rate of flow of electric charge
 - D. The energy per unit charge dissipated in a power supply
17. Two cylindrical copper wires, W_1 and W_2 , are held at the same temperature. W_2 is twice as long and has half the diameter of W_1 .

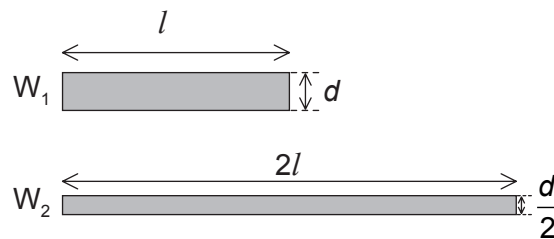

What is the ratio $\frac{\text{resistance of } W_2}{\text{resistance of } W_1}$?

- A. 1
- B. 2
- C. 4
- D. 8

18. The diagram shows a circuit used to investigate internal resistance of a cell.

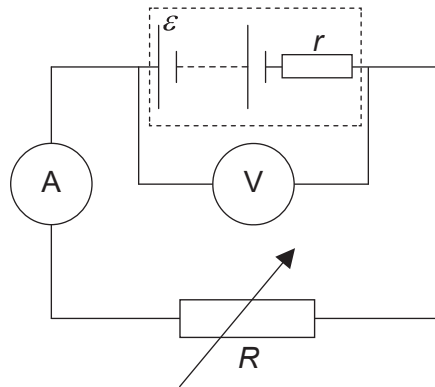

The variable resistor R is adjusted and the values of potential difference V across the cell and current I are recorded. Which graph shows the variation of V with I ?

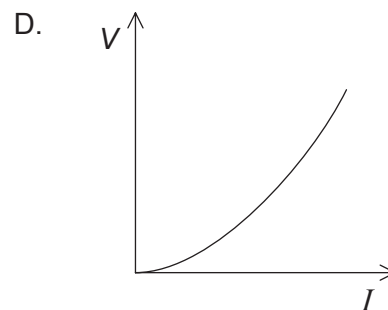
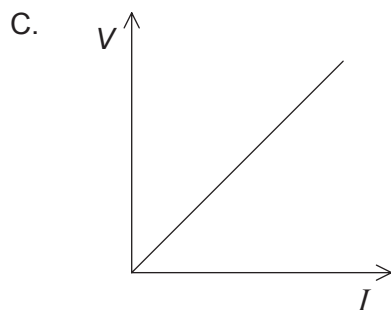
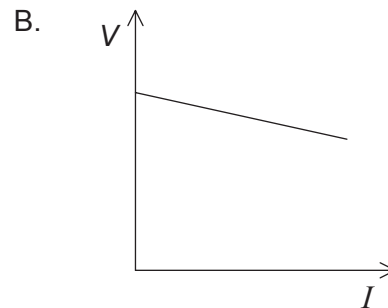
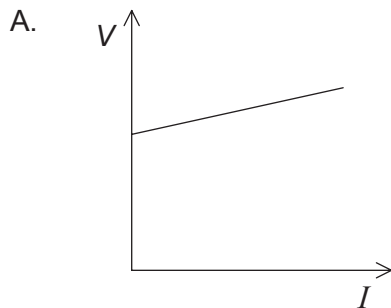

19. A planet has half the mass and half the radius of the Earth. What is the gravitational field strength at the surface of the planet? The gravitational field strength at the surface of the Earth is 10 N kg^{-1} .
- A. 2.5 N kg^{-1}
 B. 5.0 N kg^{-1}
 C. 10 N kg^{-1}
 D. 20 N kg^{-1}

20. An electron is held close to the surface of a negatively charged sphere and then released. Which describes the velocity and the acceleration of the electron after it is released?

	Velocity	Acceleration
A.	decreasing	constant
B.	decreasing	decreasing
C.	increasing	constant
D.	increasing	decreasing

21. A long, straight, current-carrying wire is placed between a pair of magnets as shown. What is the direction of the force on the wire?

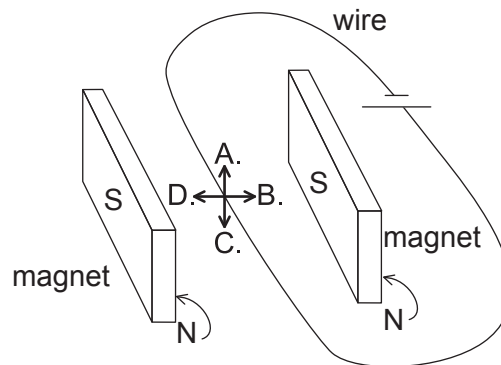

22. What is the relationship between nucleon number A , proton number Z and neutron number N ?
- A. $A = Z = N$
- B. $A + Z = N$
- C. $A - Z = N$
- D. $Z - A = N$

23. Which of the following shows an example of artificial (induced) transmutation?
- A. $\text{Am} \rightarrow \text{Np} + \alpha$
 - B. $\text{Al} + \alpha \rightarrow \text{P} + \text{n}$
 - C. $\text{C} \rightarrow \text{B} + \text{e} + \bar{\nu}$
 - D. $\text{n} \rightarrow \text{p} + \text{e} + \bar{\nu}$
24. The initial number of atoms in a pure radioactive sample is N . The radioactive half-life of the sample is defined as the
- A. time taken for one atom to undergo decay.
 - B. probability for $\frac{N}{2}$ atoms to undergo decay.
 - C. time taken for $\frac{N}{2}$ atoms to undergo decay.
 - D. probability that one atom will decay per unit time.
25. What is the approximate percentage of the world's energy needs that are provided by renewable energy sources?
- A. 10%
 - B. 30%
 - C. 50%
 - D. 70%
26. What is the purpose of the moderator in a nuclear power station?
- A. To absorb fast moving neutrons
 - B. To slow down fast moving neutrons
 - C. To initiate a chain reaction
 - D. To transfer the heat generated to a heat exchanger

27. An ocean-wave energy converter is located in a region where the average wave amplitude is A and the wave speed is v . The average power output of this converter is P .

What is the average power output of this converter when the wave amplitude is $\frac{A}{2}$ and the wave speed is $2v$?

- A. $\frac{P}{2}$
 B. P
 C. $2P$
 D. $4P$

28. Which of the following lists snow, desert and ocean in increasing order of magnitude of albedo?

	Lowest albedo \longrightarrow Highest albedo		
A.	snow	desert	ocean
B.	snow	ocean	desert
C.	ocean	desert	snow
D.	desert	ocean	snow

29. What are the units of surface heat capacity?

- A. $\text{J kg}^{-1} \text{K}^{-1}$
 B. $\text{J m}^{-2} \text{K}^{-1}$
 C. J m^{-2}
 D. $\text{J m}^{-3} \text{K}^{-1}$

30. Methane and carbon dioxide are both greenhouse gases that are believed to cause global warming. The reason for this is that these gases

- A. absorb incoming radiation from the Sun.
 B. transmit the incoming radiation from the Sun and radiation from the Earth.
 C. reflect incoming radiation from the Sun.
 D. transmit incoming radiation from the Sun and absorb outgoing radiation from the Earth.
-