



No part of this product may be reproduced in any form or by any electronic or mechanical means, including information storage and retrieval systems, without written permission from the IB.

Additionally, the license tied with this product prohibits commercial use of any selected files or extracts from this product. Use by third parties, including but not limited to publishers, private teachers, tutoring or study services, preparatory schools, vendors operating curriculum mapping services or teacher resource digital platforms and app developers, is not permitted and is subject to the IB's prior written consent via a license. More information on how to request a license can be obtained from <http://www.ibo.org/contact-the-ib/media-inquiries/for-publishers/guidance-for-third-party-publishers-and-providers/how-to-apply-for-a-license>.

Aucune partie de ce produit ne peut être reproduite sous quelque forme ni par quelque moyen que ce soit, électronique ou mécanique, y compris des systèmes de stockage et de récupération d'informations, sans l'autorisation écrite de l'IB.

De plus, la licence associée à ce produit interdit toute utilisation commerciale de tout fichier ou extrait sélectionné dans ce produit. L'utilisation par des tiers, y compris, sans toutefois s'y limiter, des éditeurs, des professeurs particuliers, des services de tutorat ou d'aide aux études, des établissements de préparation à l'enseignement supérieur, des fournisseurs de services de planification des programmes d'études, des gestionnaires de plateformes pédagogiques en ligne, et des développeurs d'applications, n'est pas autorisée et est soumise au consentement écrit préalable de l'IB par l'intermédiaire d'une licence. Pour plus d'informations sur la procédure à suivre pour demander une licence, rendez-vous à l'adresse <http://www.ibo.org/fr/contact-the-ib/media-inquiries/for-publishers/guidance-for-third-party-publishers-and-providers/how-to-apply-for-a-license>.

No se podrá reproducir ninguna parte de este producto de ninguna forma ni por ningún medio electrónico o mecánico, incluidos los sistemas de almacenamiento y recuperación de información, sin que medie la autorización escrita del IB.

Además, la licencia vinculada a este producto prohíbe el uso con fines comerciales de todo archivo o fragmento seleccionado de este producto. El uso por parte de terceros —lo que incluye, a título enunciativo, editoriales, profesores particulares, servicios de apoyo académico o ayuda para el estudio, colegios preparatorios, desarrolladores de aplicaciones y entidades que presten servicios de planificación curricular u ofrezcan recursos para docentes mediante plataformas digitales— no está permitido y estará sujeto al otorgamiento previo de una licencia escrita por parte del IB. En este enlace encontrará más información sobre cómo solicitar una licencia: <http://www.ibo.org/es/contact-the-ib/media-inquiries/for-publishers/guidance-for-third-party-publishers-and-providers/how-to-apply-for-a-license>.

Physics
Higher level
Paper 1

Friday 17 May 2019 (afternoon)

1 hour

Instructions to candidates

- Do not open this examination paper until instructed to do so.
- Answer all the questions.
- For each question, choose the answer you consider to be the best and indicate your choice on the answer sheet provided.
- A clean copy of the **physics data booklet** is required for this paper.
- The maximum mark for this examination paper is **[40 marks]**.

1. A student measures the radius R of a circular plate to determine its area. The absolute uncertainty in R is ΔR .

What is the **fractional** uncertainty in the area of the plate?

- A. $\frac{2\Delta R}{R}$
- B. $\left(\frac{\Delta R}{R}\right)^2$
- C. $\frac{2\pi\Delta R}{R}$
- D. $\pi\left(\frac{\Delta R}{R}\right)^2$
2. A proton has momentum 10^{-20} Ns and the uncertainty in the position of the proton is 10^{-10} m. What is the minimum **fractional** uncertainty in the momentum of this proton?
- A. 5×10^{-25}
- B. 5×10^{-15}
- C. 5×10^{-5}
- D. 2×10^4
3. A boy throws a ball horizontally at a speed of 15 m s^{-1} from the top of a cliff that is 80 m above the surface of the sea. Air resistance is negligible.

What is the distance from the bottom of the cliff to the point where the ball lands in the sea?

- A. 45 m
- B. 60 m
- C. 80 m
- D. 240 m

4. A book is at rest on a table. What is a pair of action–reaction forces for this situation according to Newton’s third law of motion?

	Force 1	Force 2
A.	the force of the book on the table	the force of the book on the Earth
B.	the force of the table on the Earth	the force of the book on the table
C.	the force of the Earth on the book	the force of the book on the Earth
D.	the force of the Earth on the book	the force of the table on the book

5. An object has a weight of $6.10 \times 10^2 \text{ N}$. What is the change in gravitational potential energy of the object when it moves through 8.0 m vertically?
- A. 5 kJ
B. 4.9 kJ
C. 4.88 kJ
D. 4.880 kJ

6. The graph shows the variation of momentum with time for an object.

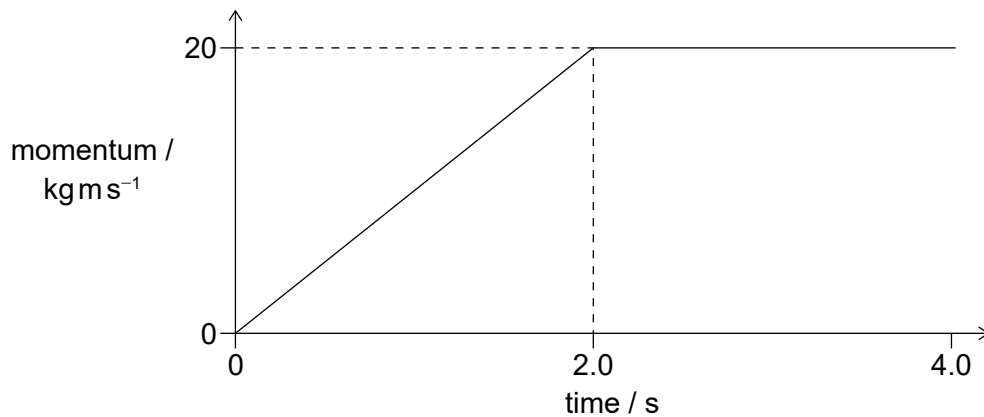

What net force acts on the object for the first 2.0 s and for the second 2.0 s of the motion?

	Force for first 2.0 s / N	Force for second 2.0 s / N
A.	10	0
B.	20	40
C.	10	40
D.	20	0

7. A table-tennis ball of mass 3 g is fired with a speed of 10 m s^{-1} from a stationary toy gun of mass 0.600 kg. The gun and ball are an isolated system.

What are the recoil speed of the toy gun and the total momentum of the system immediately after the gun is fired?

	Recoil speed of the toy gun / m s^{-1}	Total momentum of the system / kg m s^{-1}
A.	0.05	0
B.	0.05	0.03
C.	0.5	0
D.	0.5	0.03

8. A block of weight W slides down a ramp at constant velocity. A friction force F acts between the bottom of the block and the surface of the ramp. A normal reaction N acts between the ramp and the block. What is the free-body diagram for the forces that act on the block?

A.

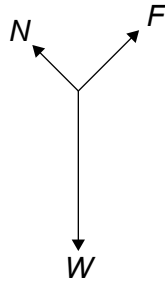

B.

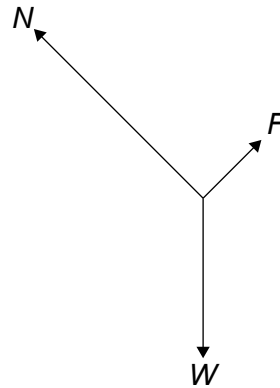

C.

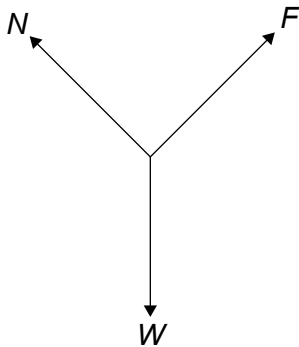

D.

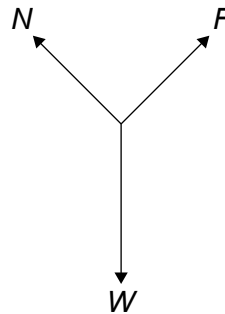

9. A substance changes from the solid phase to the gas phase without becoming a liquid and without a change in temperature.

What is true about the internal energy of the substance and the total intermolecular potential energy of the substance when this phase change occurs?

	Internal energy of the substance	Total intermolecular potential energy of the substance
A.	increases	no change
B.	no change	no change
C.	increases	increases
D.	no change	increases

10. Satellite X is in orbit around the Earth. An identical satellite Y is in a higher orbit. What is correct for the total energy and the kinetic energy of the satellite Y compared with satellite X?

	Total energy of satellite X	Kinetic energy of satellite X
A.	larger	larger
B.	smaller	larger
C.	larger	smaller
D.	smaller	smaller

11. The escape speed from a planet of radius R is v_{esc} . A satellite orbits the planet at a distance R from the surface of the planet. What is the orbital speed of the satellite?

- A. $\frac{1}{2}v_{\text{esc}}$
- B. $\frac{\sqrt{2}}{2}v_{\text{esc}}$
- C. $\sqrt{2}v_{\text{esc}}$
- D. $2v_{\text{esc}}$

12. A liquid of mass m and specific heat capacity c cools. The rate of change of the temperature of the liquid is k . What is the rate at which thermal energy is transferred from the liquid?

- A. $\frac{mc}{k}$
- B. $\frac{k}{mc}$
- C. $\frac{1}{kmc}$
- D. kmc

13. The equation $\frac{pV}{T} = \text{constant}$ is applied to a real gas where p is the pressure of the gas, V is its volume and T is its temperature.

What is correct about this equation?

- A. It is empirical.
 - B. It is theoretical.
 - C. It cannot be tested.
 - D. It cannot be disproved.
14. Cylinder X has a volume V and contains 3.0 mol of an ideal gas. Cylinder Y has a volume $\frac{V}{2}$ and contains 2.0 mol of the same gas.

The gases in X and Y are at the same temperature T . The containers are joined by a valve which is opened so that the temperatures do not change.

What is the change in pressure in X?

- A. $+\frac{1}{3}\left(\frac{RT}{V}\right)$
- B. $-\frac{1}{3}\left(\frac{RT}{V}\right)$
- C. $+\frac{2}{3}\left(\frac{RT}{V}\right)$
- D. $-\frac{2}{3}\left(\frac{RT}{V}\right)$

15. The graph shows the variation of the displacement of a wave with distance along the wave. The wave speed is 0.50 m s^{-1} .

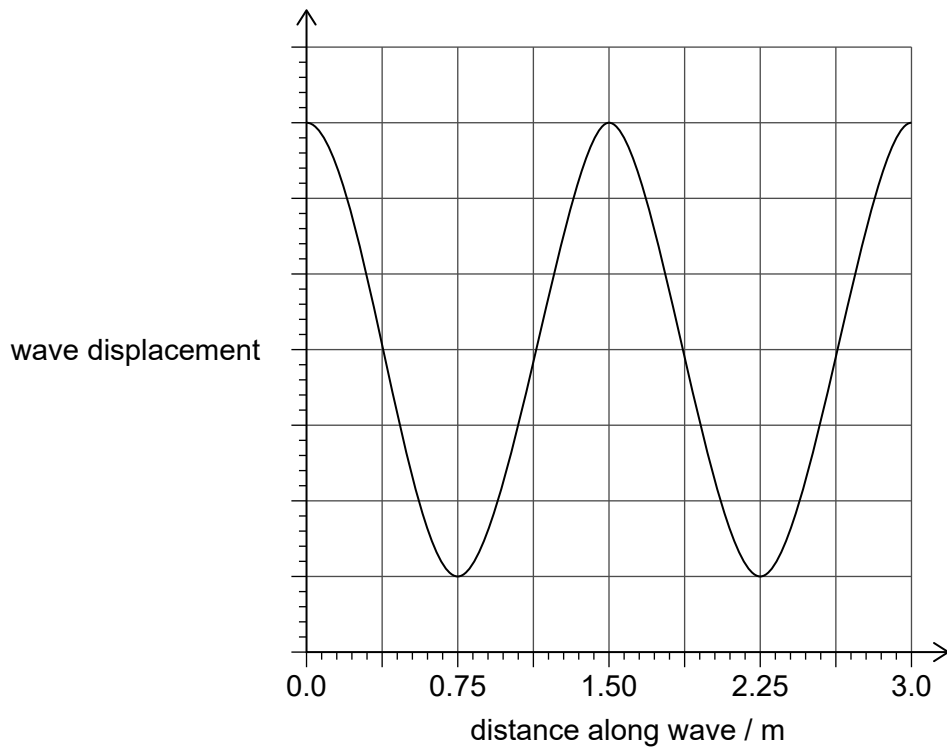

What is the period of the wave?

- A. 0.33 s
- B. 1.5 s
- C. 3.0 s
- D. 6.0 s

16. An object at the end of a spring oscillates vertically with simple harmonic motion (shm). The graph shows the variation with time t of the displacement x of the object.

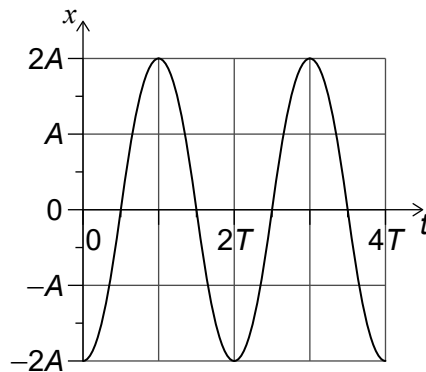

What is the velocity of the object?

- A. $-\frac{2\pi A}{T} \sin\left(\frac{\pi t}{T}\right)$
- B. $\frac{2\pi A}{T} \sin\left(\frac{\pi t}{T}\right)$
- C. $-\frac{2\pi A}{T} \cos\left(\frac{\pi t}{T}\right)$
- D. $\frac{2\pi A}{T} \cos\left(\frac{\pi t}{T}\right)$
17. A mass on a spring is displaced from its equilibrium position. Which graph represents the variation of acceleration with displacement for the mass after it is released?

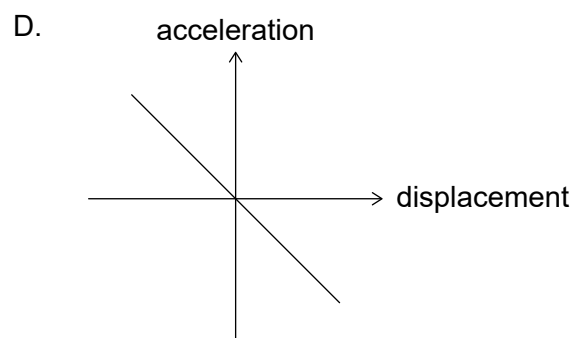
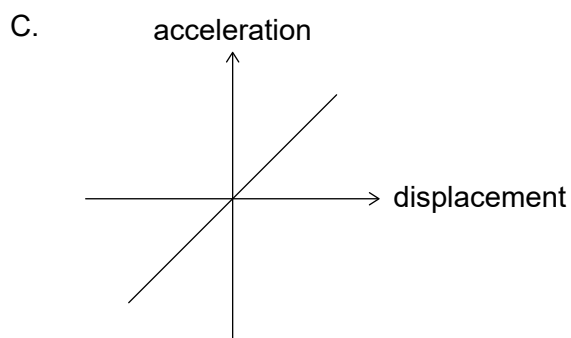
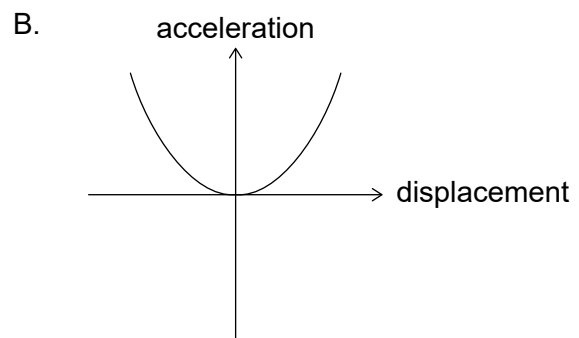
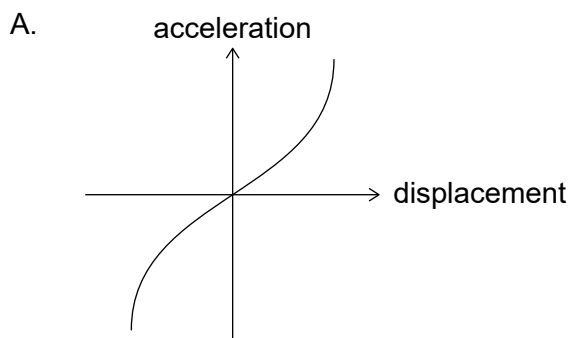

18. Unpolarized light is incident on two polarizers. The axes of polarization of both polarizers are initially parallel. The second polarizer is then rotated through 360° as shown.

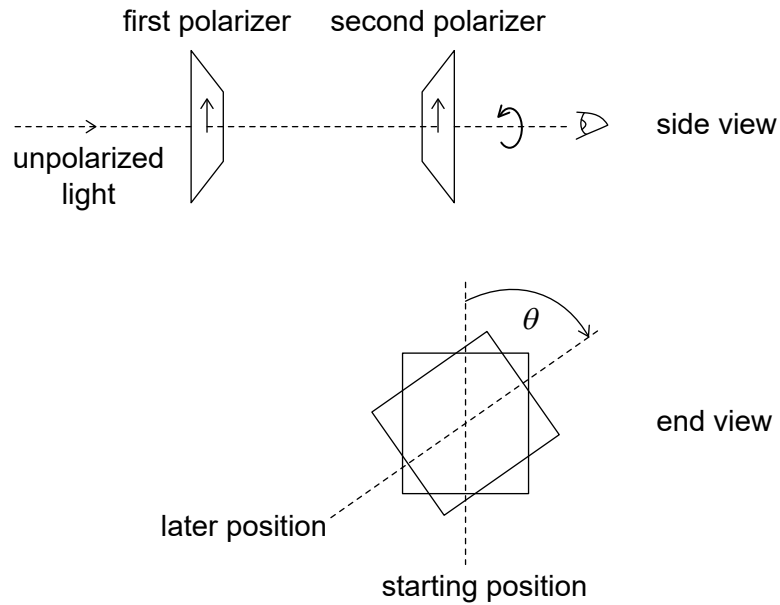

Which graph shows the variation of intensity with angle θ for the light leaving the second polarizer?

A.

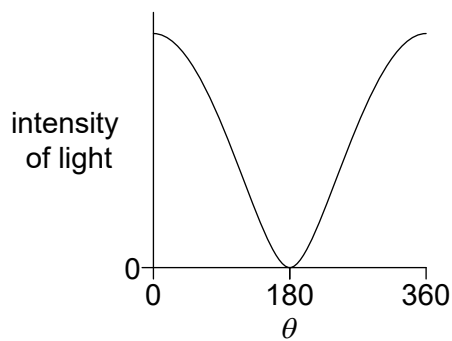

B.

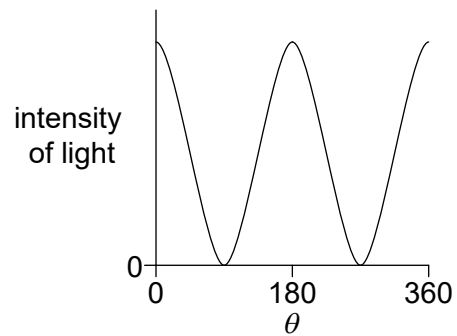

C.

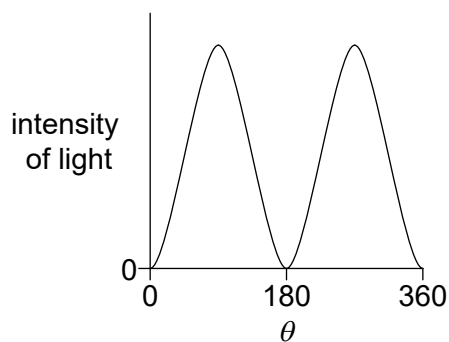

D.

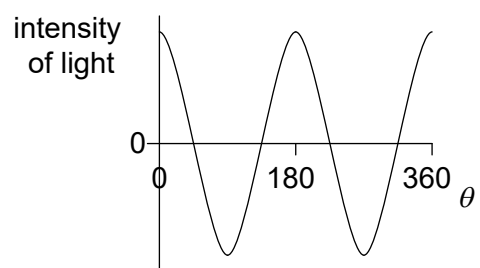

19. A student blows across the top of a cylinder that contains water. A first-harmonic standing sound wave is produced in the air of the cylinder. More water is then added to the cylinder. The student blows so that a first-harmonic standing wave is produced with a different frequency.

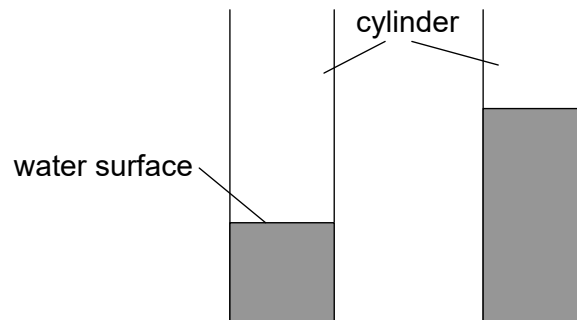

What is the nature of the displacement in the air at the water surface and the change in frequency when the water is added?

	Nature of displacement	Change in frequency
A.	antinode	decrease
B.	antinode	increase
C.	node	decrease
D.	node	increase

20. A third-harmonic standing wave of wavelength 0.80 m is set up on a string fixed at both ends. Two points on the wave are separated by a distance of 0.60 m. What is a possible phase difference between the two points on the wave?

- A. $\frac{\pi}{4}$ rad
- B. $\frac{\pi}{2}$ rad
- C. π rad
- D. $\frac{3\pi}{2}$ rad

21. A train approaches a station and sounds a horn of constant frequency and constant intensity. An observer waiting at the station detects a frequency f_{obs} and an intensity I_{obs} . What are the changes, if any, in I_{obs} and f_{obs} as the train slows down?

	I_{obs}	f_{obs}
A.	no change	decreases
B.	increases	increases
C.	no change	increases
D.	increases	decreases

22. Two stars are viewed with a telescope using a green filter. The images of the stars are just resolved. What is the change, if any, to the angular separation of the images of the stars and to the resolution of the images when the green filter is replaced by a violet filter?

	Angular separation of the stars	Resolution of the images
A.	no change	remains resolved
B.	decreases	no longer resolved
C.	decreases	remains resolved
D.	no change	no longer resolved

23. A particle with a charge ne is accelerated through a potential difference V .

What is the magnitude of the work done on the particle?

- A. eV
 B. neV
 C. $\frac{nV}{e}$
 D. $\frac{eV}{n}$

24. In an experiment to determine the resistivity of a material, a student measures the resistance of several wires made from the pure material. The wires have the same length but different diameters.

Which quantities should the student plot on the x -axis and the y -axis of a graph to obtain a straight line?

	x -axis	y -axis
A.	diameter ²	resistance
B.	diameter	resistance
C.	diameter ²	$\frac{1}{\text{resistance}}$
D.	diameter	$\frac{1}{\text{resistance}}$

25. Three resistors of resistance 1.0Ω , 6.0Ω and 6.0Ω are connected as shown. The voltmeter is ideal and the cell has an emf of 12V with negligible internal resistance.

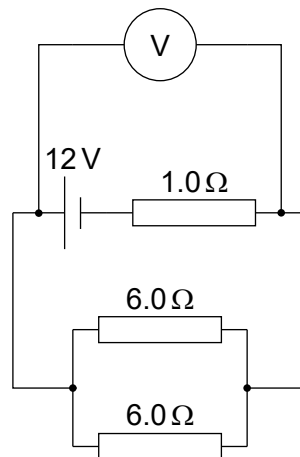

What is the reading on the voltmeter?

- A. 3.0V
- B. 4.0V
- C. 8.0V
- D. 9.0V

26. The input to a diode bridge rectification circuit is sinusoidal with a time period of 20 ms.

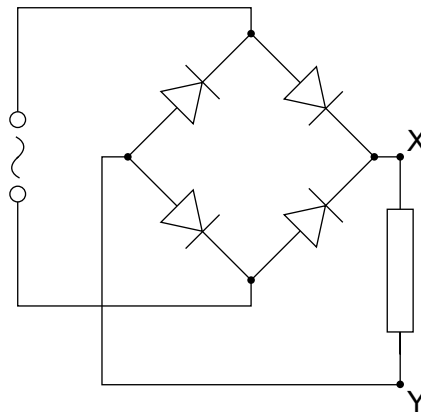

Which graph shows the variation with time t of the output voltage V_{out} between X and Y?

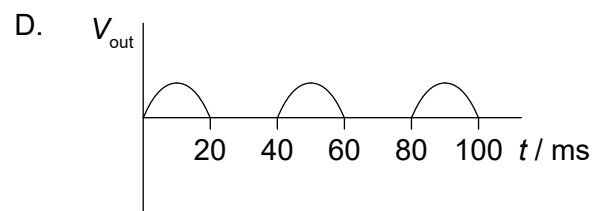
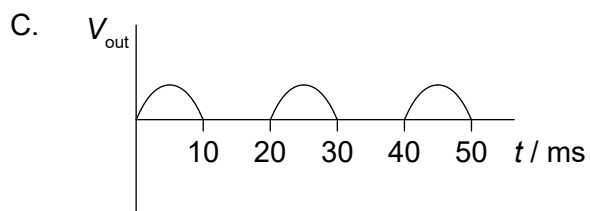
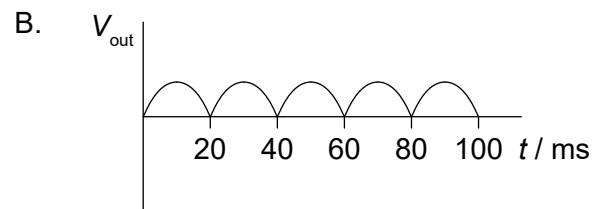
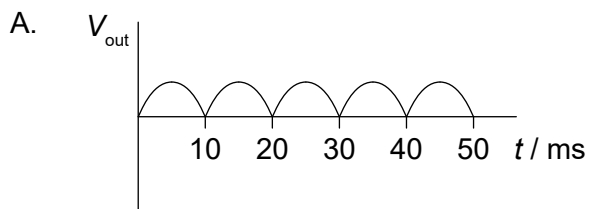

27. Three identical capacitors are connected in series. The total capacitance of the arrangement is $\frac{1}{9}$ mF. The three capacitors are then connected in parallel. What is the capacitance of the parallel arrangement?

- A. $\frac{1}{3}$ mF
 B. 1 mF
 C. 3 mF
 D. 81 mF

28. A transformer with 600 turns in the primary coil is used to change an alternating root mean square (rms) potential difference of $240V_{\text{rms}}$ to $12V_{\text{rms}}$.

When connected to the secondary coil, a lamp labelled “120W, 12V” lights normally. The current in the primary coil is 0.60A when the lamp is lit.

What are the number of secondary turns and the efficiency of the transformer?

	Number of secondary turns	Efficiency
A.	12000	99 %
B.	30	99 %
C.	12000	83 %
D.	30	83 %

29. A circular coil of wire moves through a region of uniform magnetic field directed out of the page.

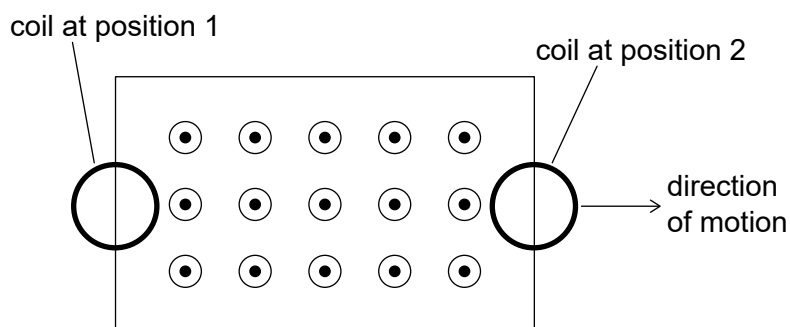

What is the direction of the induced conventional current in the coil for the marked positions?

	Position 1	Position 2
A.	clockwise	clockwise
B.	counterclockwise	clockwise
C.	clockwise	counterclockwise
D.	counterclockwise	counterclockwise

30. An electron is fixed in position in a uniform electric field. What is the position for which the electrical potential energy of the electron is greatest?

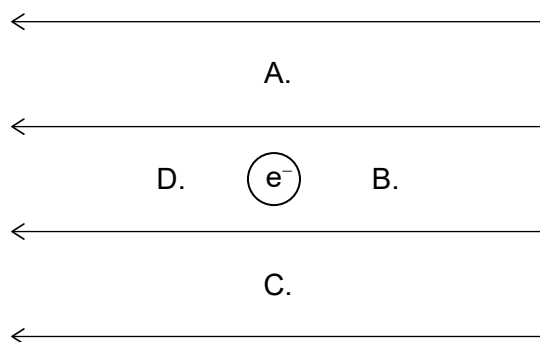

31. A proton of velocity v enters a region of electric and magnetic fields. The proton is not deflected. An electron and an alpha particle enter the same region with velocity v . Which is correct about the paths of the electron and the alpha particle?

	Path of electron	Path of alpha particle
A.	deflected	deflected
B.	deflected	not deflected
C.	not deflected	deflected
D.	not deflected	not deflected

32. A particle of mass 0.02 kg moves in a horizontal circle of diameter 1 m with an angular velocity of $3\pi \text{ rad s}^{-1}$.

What is the magnitude and direction of the force responsible for this motion?

	Magnitude of force / N	Direction of force
A.	0.03π	away from centre of circle
B.	0.03π	towards centre of circle
C.	$0.09\pi^2$	away from centre of circle
D.	$0.09\pi^2$	towards centre of circle

33. A radioactive nuclide with atomic number Z undergoes a process of beta-plus (β^+) decay. What is the atomic number for the nuclide produced and what is another particle emitted during the decay?

	Atomic number	Particle
A.	$Z - 1$	neutrino
B.	$Z + 1$	neutrino
C.	$Z - 1$	anti-neutrino
D.	$Z + 1$	anti-neutrino

34. The π^+ meson contains an up (u) quark. What is the quark structure of the π^- meson?

- A. ud
 B. $u\bar{d}$
 C. $\bar{u}d$
 D. $\bar{u}\bar{d}$

35. Three conservation laws in nuclear reactions are

- I. conservation of charge
 II. conservation of baryon number
 III. conservation of lepton number.

The reaction

$$n \rightarrow \pi^- + e^+ + \bar{\nu}_e$$

is proposed.

Which conservation laws are violated in the proposed reaction?

- A. I and II only
 B. I and III only
 C. II and III only
 D. I, II and III

36. A neutron collides head-on with a stationary atom in the moderator of a nuclear power station. The kinetic energy of the neutron changes as a result. There is also a change in the probability that this neutron can cause nuclear fission.

What are these changes?

	Change in kinetic energy of the neutron	Change in probability of causing nuclear fission
A.	increase	increase
B.	decrease	increase
C.	increase	decrease
D.	decrease	decrease

37. The orbital radius of the Earth around the Sun is 1.5 times that of Venus. What is the intensity of solar radiation at the orbital radius of Venus?

- A. 0.6 kW m^{-2}
 B. 0.9 kW m^{-2}
 C. 2 kW m^{-2}
 D. 3 kW m^{-2}

38. Photons of a certain frequency incident on a metal surface cause the emission of electrons from the surface. The intensity of the light is constant and the frequency of photons is increased. What is the effect, if any, on the number of emitted electrons and the energy of emitted electrons?

	Number of emitted electrons	Energy of emitted electrons
A.	no change	no change
B.	decrease	increase
C.	decrease	no change
D.	no change	increase

39. Three possible features of an atomic model are

- I. orbital radius
- II. quantized energy
- III. quantized angular momentum.

Which of these are features of the Bohr model for hydrogen?

- A. I and II only
 - B. I and III only
 - C. II and III only
 - D. I, II, and III
40. Photons of discrete energy are emitted during gamma decay. This is evidence for
- A. atomic energy levels.
 - B. nuclear energy levels.
 - C. pair annihilation.
 - D. quantum tunneling.
-