

OCR

Oxford Cambridge and RSA

H**GCSE (9–1) Mathematics****J560/04** Paper 4 (Higher Tier)**Tuesday 6 November 2018 – Morning****Time allowed: 1 hour 30 minutes****You may use:**

- a scientific or graphical calculator
- geometrical instruments
- tracing paper



First name

Last name

Centre
numberCandidate
number**INSTRUCTIONS**

- Use black ink. You may use an HB pencil for graphs and diagrams.
- Complete the boxes above with your name, centre number and candidate number.
- Answer **all** the questions.
- Read each question carefully before you start to write your answer.
- Where appropriate, your answers should be supported with working. Marks may be given for a correct method even if the answer is incorrect.
- Write your answer to each question in the space provided. Additional paper may be used if required but you must clearly show your candidate number, centre number and question number(s).
- Do **not** write in the barcodes.

INFORMATION

- The total mark for this paper is **100**.
- The marks for each question are shown in brackets [].
- Use the π button on your calculator or take π to be 3.142 unless the question says otherwise.
- This document consists of **20** pages.

2

Answer **all** the questions.

- 1 Shari buys a box of 60 candles for £125.
She sells the candles for £2.25 each.

Calculate her percentage profit.

..... % [4]

- 2 Hector can run 400 metres in 66 seconds.

(a) Use this information to show that he could run 5 kilometres in less than 14 minutes. [4]

(b) Hector tries to run 5 kilometres in less than 14 minutes.

Give one reason why he might not achieve this.

.....
..... [1]

3

3 Here is Mario's answer to a question.

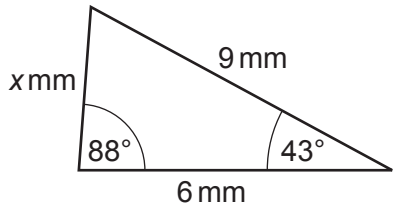
<p>Question 3</p>  <p>Work out the value of x.</p>	<p>Answer</p> $x = \sqrt{9^2 - 6^2}$ $x = \sqrt{45}$ $x = 6.708 \text{ (3 d.p.)}$
--	---

Explain the error in Mario's method.

.....

..... [1]

4

4 Here are the interest rates for two bank accounts.

Northern Savings Bank (NSB)

2.5% per year
compound interest

Central Alliance Bank (CAB)

2.7% per year
simple interest

Mia puts £6400 in each account.

Calculate the difference in value between the two accounts after 8 years.
Give your answer correct to the nearest penny.

£ [6]

5

- 5 Marcin buys 7 rulers and 15 crayons for £7.
A ruler costs 12p more than a crayon.

Find the cost of one crayon.

cost of one crayon = p [5]

6

6 The diagram shows a cylinder and a sphere.

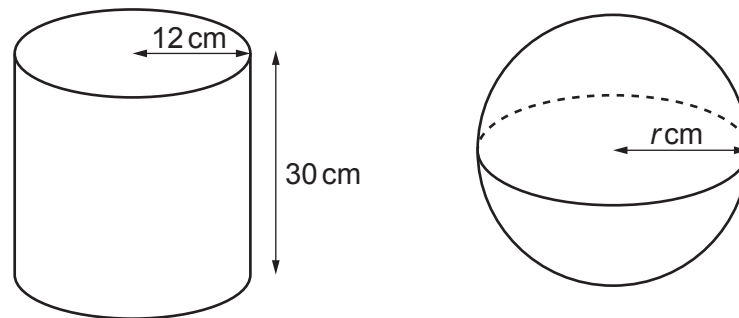

The cylinder has radius 12 cm and height 30 cm.
The cylinder and the sphere have the same volume.

Work out the radius r cm of the sphere.

[The volume V of a sphere with radius r is $V = \frac{4}{3}\pi r^3$.]

..... cm [5]

7

7 The diagram shows triangle ABC.

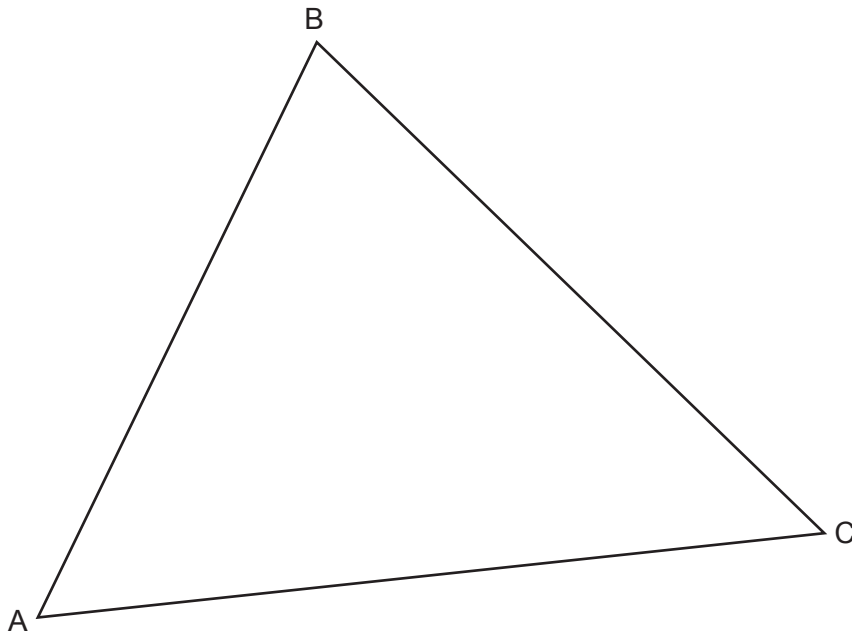

- (a) Construct the bisector of angle BAC. [2]
- (b) Construct the perpendicular bisector of AC. [2]
- (c) Shade the region inside triangle ABC that is
- nearer to AC than to AB
 - nearer to A than to C.
- [1]

8

- 8 (a) Two numbers, P and Q , are written as products of their prime factors.

$$P = 2^5 \times 3^2 \times 5^3 \times 11 \qquad Q = 2^4 \times 3 \times 5^4 \times 7$$

- (i) Find the lowest common multiple (LCM) of P and Q .

(a)(i) [2]

- (ii) The number C is written as the product of its prime factors.

$$C = 2^3 \times 3 \times 5^2$$

Work out $P \div C$, leaving your answer as a product of powers of prime numbers.

(ii) [2]

- (b) (i) Write 450 as a product of its prime factors.

(b)(i) [3]

- (ii) Find the highest common factor (HCF) of 270 and 450.

(ii) [3]

9 72 children are asked whether they have a laptop or an iPad.

- 31 have a laptop.
- 48 have an iPad.
- 12 have both.
- 5 have neither.

(a) Represent this information on a Venn diagram.

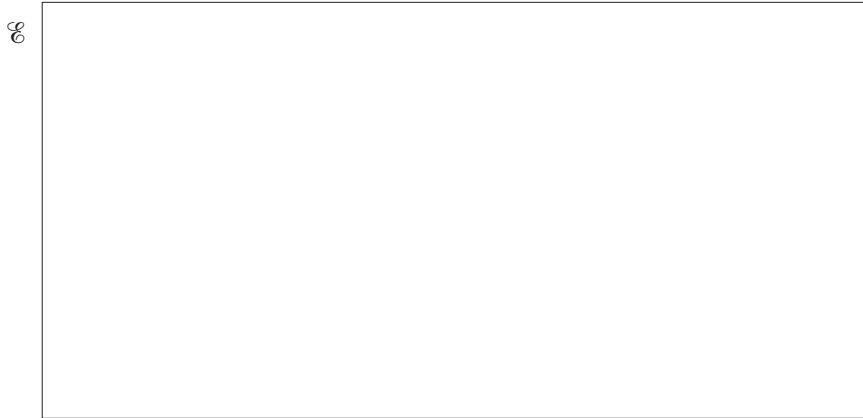

[3]

(b) One of the children is chosen at random.

Write down the probability that they have an iPad but not a laptop.

(b) [2]

10

10 Here is the graph of $y = x^2 + x - 6$.

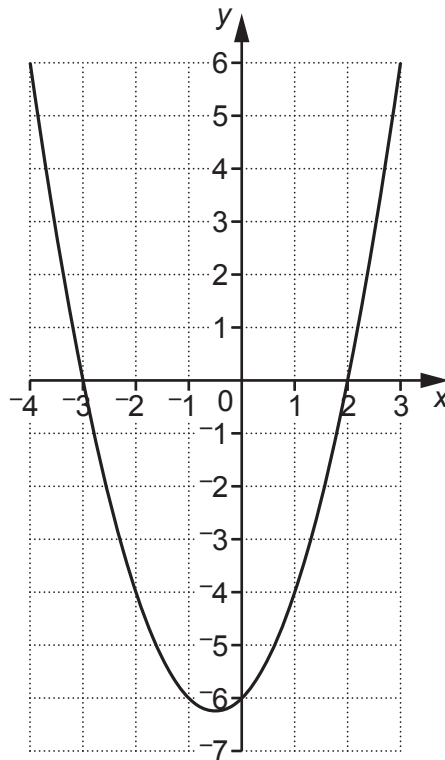

Use the graph to solve the equation $x^2 + x - 6 = 0$.

$x = \dots\dots\dots$ or $x = \dots\dots\dots$ [2]

11 Here are two functions.

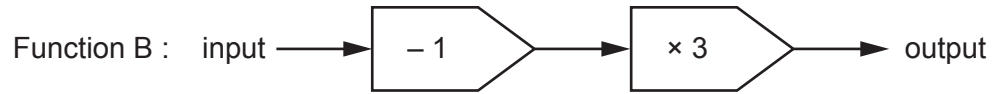

Composite function C is shown below.



(a) The output from function C is 54.

Work out the input.

(a) [2]

(b) The input to function C is x .

Find an expression, in terms of x , for the output from function C.

(b) [2]

12

- 12 30 students completed a puzzle and their times were recorded. All of the students completed the puzzle in less than 50 seconds. The histogram shows information about some of their times.

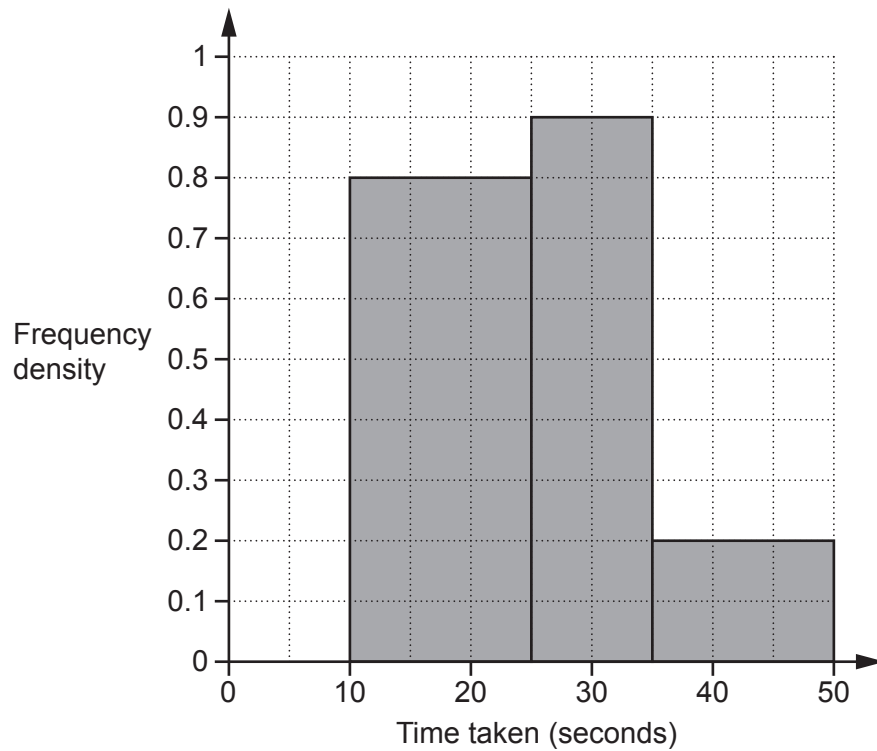

Complete the histogram for those completing the puzzle in less than 10 seconds.

[5]

13 Tenzin is given this question.

Factorise fully.

$$2x^2 + 6x$$

Here is his answer.

$$2x^2 + 6x = x(2x + 6)$$

Explain why Tenzin's answer is not correct.

.....
..... [1]

14 y is inversely proportional to the square root of x .
 y is 40 when x is 9.

Find a formula linking x and y .

..... [3]

15 The box plot shows the distribution of the runs scored by David in some cricket matches.

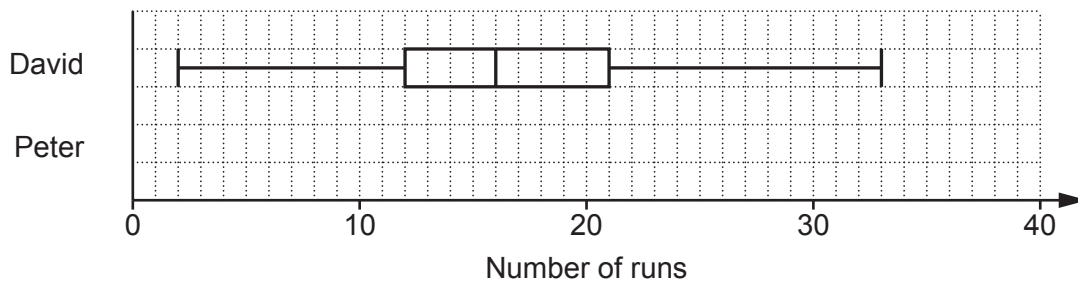

(a) Another player, Peter, has

- a median score of 26
- a highest score of 39
- a lowest score of 8
- a lower quartile of 14
- an inter-quartile range of 18.

Show the distribution of Peter’s scores as a box plot on the diagram above.

[2]

(b) Decide whether David or Peter best satisfies each of these questions. Give a reason for each of your decisions.

(i) Who scored more runs on average?

..... because
 [1]

(ii) Whose scores were more consistent?

..... because
 [1]

15

16 Solve by factorisation.

$$2x^2 - 19x - 33 = 0$$

$$x = \dots\dots\dots \text{ or } x = \dots\dots\dots \quad [3]$$

17 Here are the first four terms of a quadratic sequence.

2 15 34 59

The n th term is $an^2 + bn + c$.

Find the values of a , b and c .

$$a = \dots\dots\dots$$

$$b = \dots\dots\dots$$

$$c = \dots\dots\dots \quad [4]$$

16

18 P is the point (0, -1) and Q is the point (5, 9).

Find the equation of the line through P that is perpendicular to the line PQ.

..... [5]

17

19 Two cylinders, A and B, are mathematically similar.

Cylinder A has volume 2400 cm^3 and height 12 cm.
Cylinder B has volume 750 cm^3 .

Find the height of cylinder B.
Give your answer correct to an appropriate degree of accuracy.

.....cm [5]

18

20 The diagram shows a right-angled triangular prism ABCDEF.

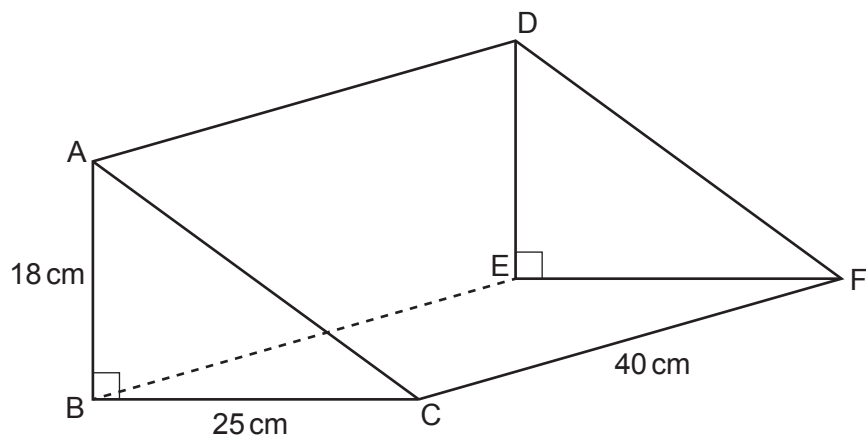

Calculate angle AFB.

..... ° [6]

19

- 21 The number of gannets on an island is assumed to follow this exponential growth model.

$$N = 0.45 \times 1.07^x$$

N is the number of gannets, in thousands.

x is the number of years after 1st January 2010.

- (a) Complete the table for $N = 0.45 \times 1.07^x$.

x	0	5	10	15	20
N	0.45	0.63		1.24	

[2]

- (b) Draw the graph of $N = 0.45 \times 1.07^x$.

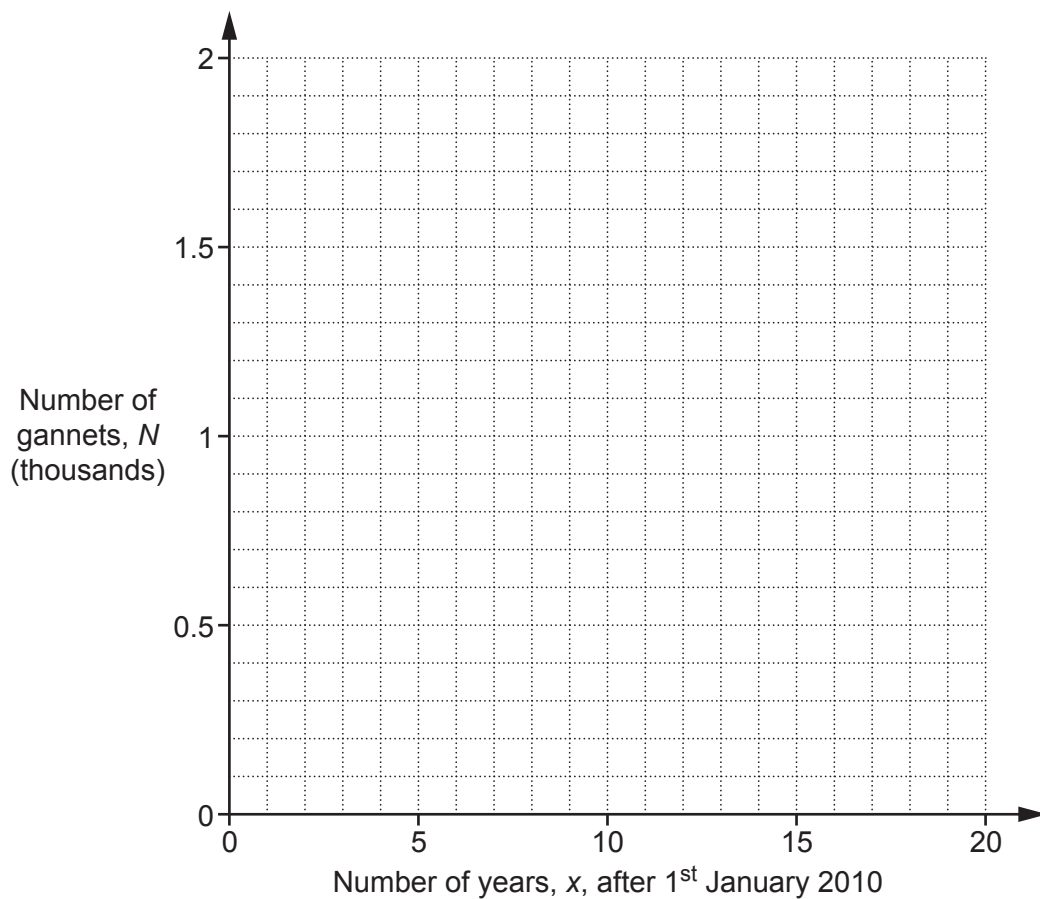

[2]

- (c) Use the graph to find **the year** when the gannet population is predicted to reach 1000.

(c) [2]

Turn over for Question 22

20

22 In a village the ratio of males to females is 2 : 1.

40% of the people in the village are right-handed males.
25% of the people in the village are right-handed females.

Show that the proportion of females who are right-handed is greater than the proportion of males who are right-handed. [6]

END OF QUESTION PAPER

OCR

Oxford Cambridge and RSA

Copyright Information

OCR is committed to seeking permission to reproduce all third-party content that it uses in its assessment materials. OCR has attempted to identify and contact all copyright holders whose work is used in this paper. To avoid the issue of disclosure of answer-related information to candidates, all copyright acknowledgements are reproduced in the OCR Copyright Acknowledgements Booklet. This is produced for each series of examinations and is freely available to download from our public website (www.ocr.org.uk) after the live examination series.

If OCR has unwittingly failed to correctly acknowledge or clear any third-party content in this assessment material, OCR will be happy to correct its mistake at the earliest possible opportunity.

For queries or further information please contact The OCR Copyright Team, The Triangle Building, Shaftesbury Road, Cambridge CB2 8EA.

OCR is part of the Cambridge Assessment Group; Cambridge Assessment is the brand name of University of Cambridge Local Examinations Syndicate (UCLES), which is itself a department of the University of Cambridge.