

Write your name here

Surname

Other names

Pearson Edexcel Certificate
Pearson Edexcel
International GCSE

Centre Number

--	--	--	--	--	--

Candidate Number

--	--	--	--	--	--

Mathematics A

Paper 2F



Foundation Tier

Wednesday 15 January 2014 – Morning
Time: 2 hours

Paper Reference
4MA0/2F
KMA0/2F

You must have:

Ruler graduated in centimetres and millimetres, protractor, compasses, pen, HB pencil, eraser, calculator. Tracing paper may be used.

Total Marks

Instructions

- Use **black** ink or ball-point pen.
- **Fill in the boxes** at the top of this page with your name, centre number and candidate number.
- Answer **all** questions.
- Without sufficient working, correct answers may be awarded no marks.
- Answer the questions in the spaces provided
– *there may be more space than you need.*
- **Calculators may be used.**
- You must **NOT** write anything on the formulae page.
Anything you write on the formulae page will gain NO credit.

Information

- The total mark for this paper is 100.
- The marks for **each** question are shown in brackets
– *use this as a guide as to how much time to spend on each question.*

Advice

- Read each question carefully before you start to answer it.
- Check your answers if you have time at the end.

Turn over ►

P42939A

©2014 Pearson Education Ltd.

5/6/1/1/



P 4 2 9 3 9 A 0 1 2 0

PEARSON
PAPACAMBRIDGE

International GCSE MATHEMATICS
FORMULAE SHEET – FOUNDATION TIER

Pythagoras' Theorem
 $a^2 + b^2 = c^2$

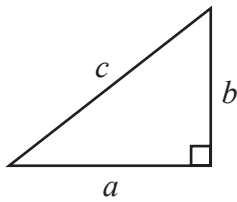

Area of a trapezium = $\frac{1}{2}(a + b)h$

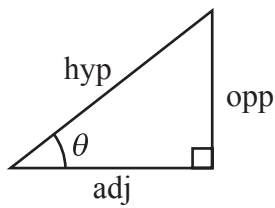
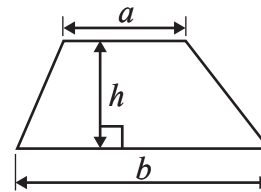

adj = hyp \times cos θ
opp = hyp \times sin θ
opp = adj \times tan θ

Volume of prism = area of cross section \times length

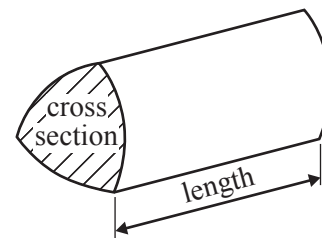

or $\sin \theta = \frac{\text{opp}}{\text{hyp}}$

$\cos \theta = \frac{\text{adj}}{\text{hyp}}$

$\tan \theta = \frac{\text{opp}}{\text{adj}}$

Circumference of circle = $2\pi r$

Area of circle = πr^2

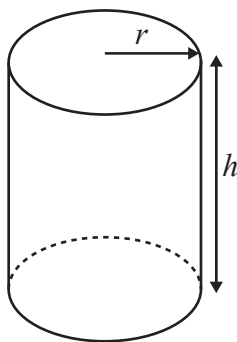

Volume of cylinder = $\pi r^2 h$

Curved surface area
of cylinder = $2\pi r h$

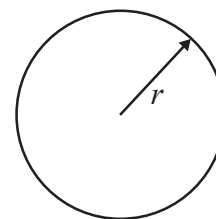

Answer ALL TWENTY TWO questions.

Write your answers in the spaces provided.

You must write down all the stages in your working.

- 1** One day, Robin recorded the number of people getting on his bus at each of six stops.
Here are his results.

14 4 8 11 12 10

From these numbers, write down

- (i) the odd number
 (ii) the multiple of 3
 (iii) the square number
 (iv) the factor of 30

(Total for Question 1 is 4 marks)

2

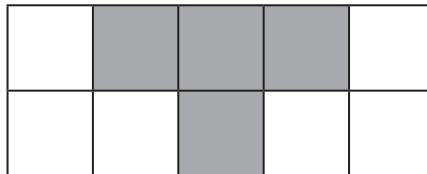

- (i) What percentage of this shape is shaded?
 %
- (ii) Write your answer to part (i) as a decimal.

(Total for Question 2 is 2 marks)

Do NOT write in this space.



- 3 (a) Work out the number which is exactly halfway between 1.2 and 1.4

.....
(1)

- (b) Here is a scale which shows a weight in kilograms.
What is the reading on the scale?

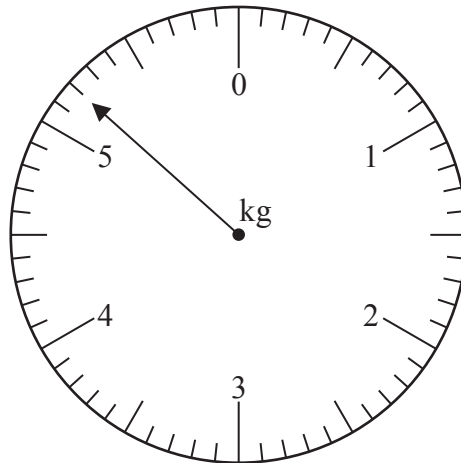

..... kg
(1)

- (c) On the scale below, mark with an arrow a reading of 0.4 kilograms.

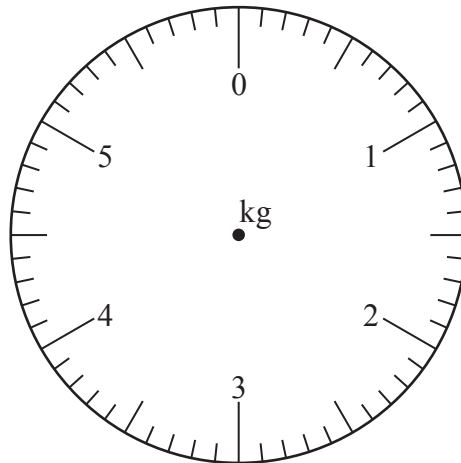

(1)







- (d) Change 0.4 kilograms to grams.

..... grams
(1)

(Total for Question 3 is 4 marks)



- 4 The pictogram shows information about the number of people who visited a cafe on each of six days.

Monday	
Tuesday	
Wednesday	
Thursday	
Friday	
Saturday	

- (a) On which day did the greatest number of people visit the cafe?

.....
(1)

On Monday, 60 people visited the cafe.

- (b) (i) How many people does  represent?

- (ii) Find the number of people who visited the cafe on Tuesday.

- (iii) Find the number of people who visited the cafe on Friday.

.....
(3)

On Saturday, 65% of people who visited the cafe were female.

- (c) What percentage of people who visited the cafe on Saturday were not female?

..... %
(1)

- (d) Write 65% as a fraction.
Give your answer in its simplest form.

.....
(2)

(Total for Question 4 is 7 marks)



5 Complete the following sentences by writing a sensible metric unit on each of the dotted lines.

- (i) The distance from Paris to Madrid is 1053
- (ii) The area of a basketball court is 420
- (iii) The volume of a can of cola is 330

(Total for Question 5 is 3 marks)

6 The diagram shows a fair spinner with 6 sections.

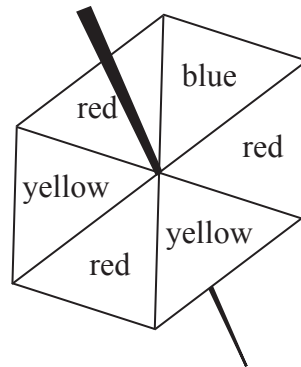

Three sections are red, two sections are yellow and one section is blue.
David spins the spinner once.

On the probability scale, mark with a cross (×) the probability that

- (i) the spinner lands on red.
Label this cross R.
- (ii) the spinner lands on blue.
Label this cross B.
- (iii) the spinner lands on green.
Label this cross G.

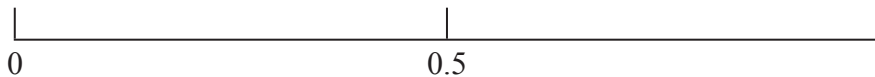

(Total for Question 6 is 3 marks)

Do NOT write in this space.



7 The table shows the temperatures at 2 pm in five French ski resorts.

Ski resort	Temperature ($^{\circ}\text{C}$)
Alpe d'Huez	- 5
Risoul	- 2
Tignes	- 8
Meribel	3
Chamonix	- 1

(a) Which ski resort had the highest temperature?

.....
(1)

(b) Work out the difference in temperature between Alpe d'Huez and the ski resort with the lowest temperature.

..... $^{\circ}\text{C}$
(2)

By midnight, the temperature in Risoul had fallen by 14°C .

(c) (i) Work out the temperature in Risoul at midnight.

..... $^{\circ}\text{C}$

(ii) Work out the length of time between 2 pm and midnight.

..... hours
(3)

(Total for Question 7 is 6 marks)

Do NOT write in this space.



8 Budget Taxis use this rule to work out the cost, in euros (€), for taxi journeys.

3 euros
plus
2 euros for each kilometre travelled

- (a) Claude travelled 4 kilometres in a Budget Taxi.
What was the cost of Claude's journey?

€
(2)

- (b) Bridgette travelled in a Budget Taxi.
The cost was 35 euros.
How many kilometres did Bridgette travel?

..... km
(2)

Economy Taxis use this rule to work out their cost, in euros (€), for taxi journeys.

8 euros
plus
1 euro for each kilometre travelled

- (c) Find the distance, in kilometres, for which the cost of a journey in a Budget Taxi is the same as the cost of a journey in an Economy Taxi.

..... km
(2)

(Total for Question 8 is 6 marks)



9 Usain runs in a race.

The graph shows his speed, in metres per second (m/s), during the first 10 seconds of the race.

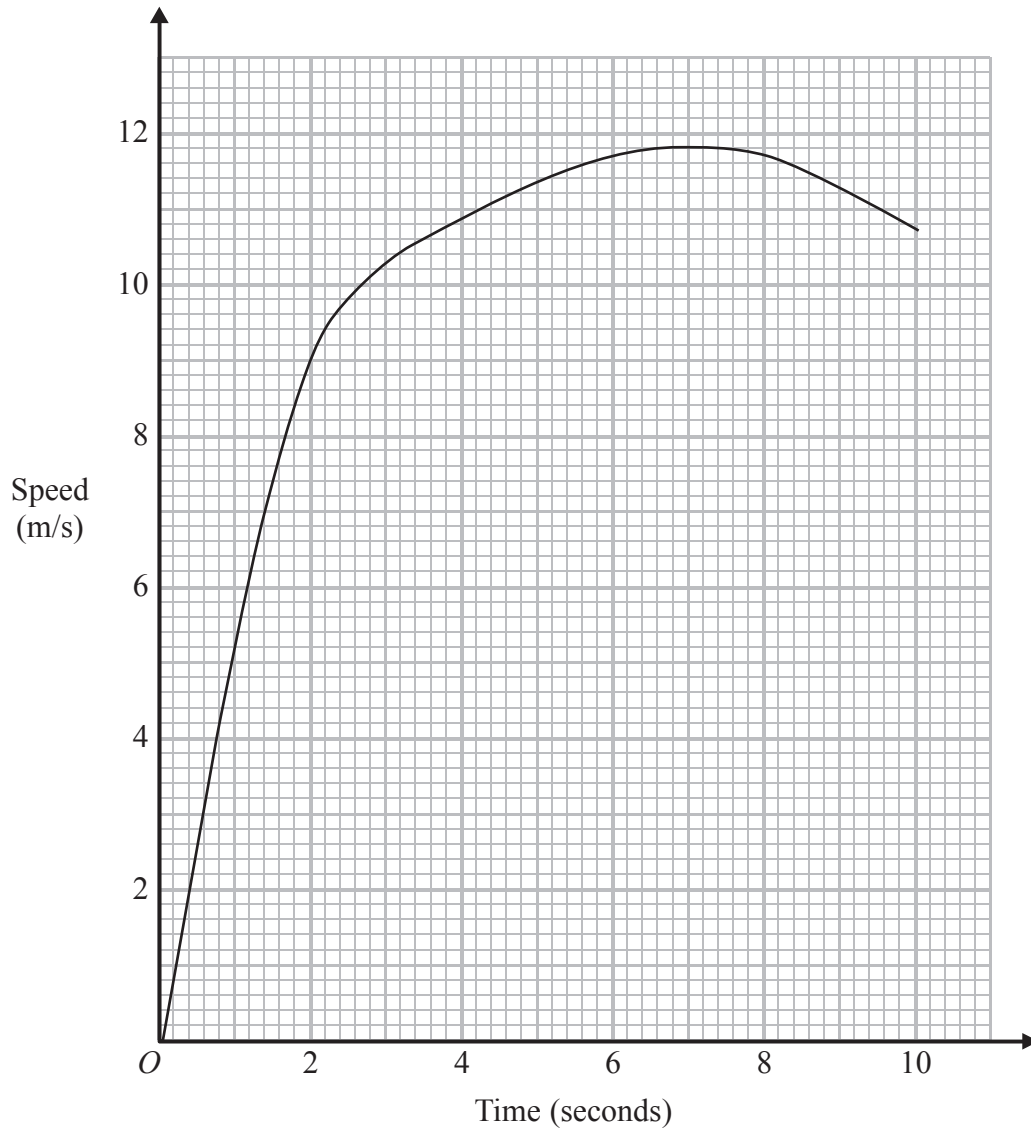

(a) Write down Usain's speed at 2 seconds.

..... m/s
(1)

(b) Write down Usain's greatest speed.

..... m/s
(1)

(c) Write down the time at which Usain's speed was 7 m/s.

..... seconds
(1)

(Total for Question 9 is 3 marks)



- 10 The pie chart shows information about the use of water by people in a village in Zambia on one day.

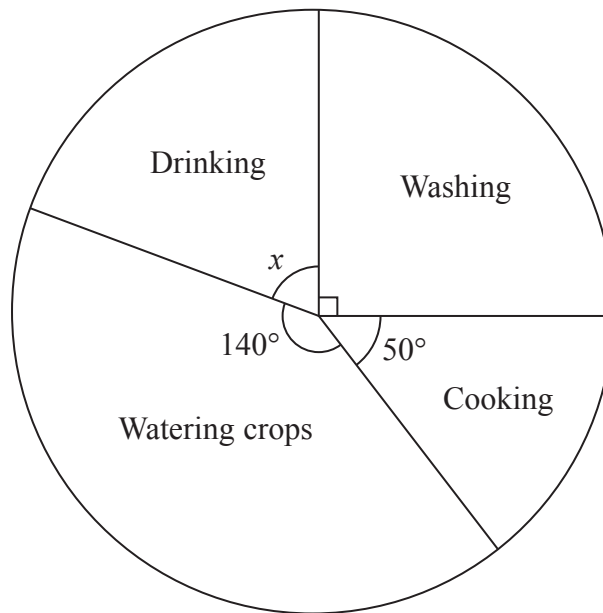

Diagram **NOT** accurately drawn

- (a) (i) Calculate the size of angle x .

.....

- (ii) Explain how you found your answer.

.....
(2)

- (b) 90 litres of water were used for cooking.
How many litres were used for watering crops?

..... litres

(3)

(Total for Question 10 is 5 marks)

11

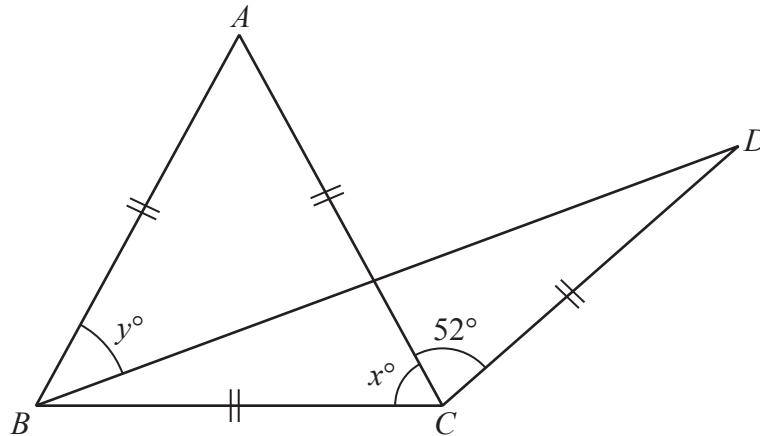
Diagram NOT
accurately drawn

The diagram shows an equilateral triangle ABC and an isosceles triangle BCD .

$AB = AC = BC = CD$.

Angle $ACD = 52^\circ$

Angle $ACB = x^\circ$

(i) Find the value of x .

Angle $ABD = y^\circ$

$x = \dots\dots\dots$

(ii) Work out the value of y .

$y = \dots\dots\dots$

(Total for Question 11 is 4 marks)

Do NOT write in this space.



- 12 (a) Write these numbers in order of size.
Start with the smallest number.

$$65\% \qquad \frac{5}{8} \qquad 0.66 \qquad \frac{2}{3} \qquad \frac{3}{5}$$

.....
(3)

- (b) Work out the square root of $\frac{1}{16}$ giving your answer as a fraction.

.....
(1)

- (c) Show that $\frac{11}{12} - \frac{3}{4} = \frac{1}{6}$

.....
(2)

(Total for Question 12 is 6 marks)

- 13 Solve $6(3y + 5) = 39$
Show clear algebraic working.

$y =$

(Total for Question 13 is 3 marks)

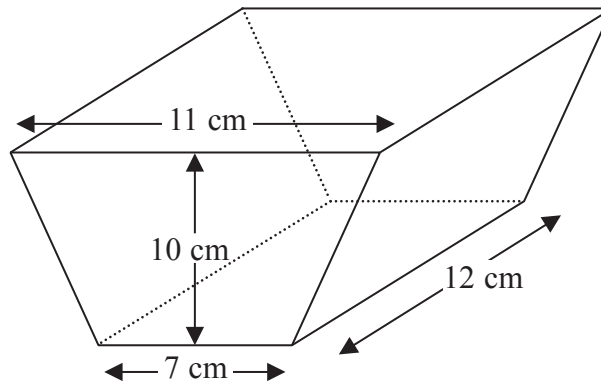

14

Diagram NOT
accurately drawn

The diagram shows a solid prism.
 The cross section of the prism is a trapezium.
 The lengths of the parallel sides of the trapezium are 11 cm and 7 cm.
 The perpendicular distance between the parallel sides of the trapezium is 10 cm.
 The length of the prism is 12 cm.

(a) How many faces has this prism?

.....
(1)

(b) How many vertices has this prism?

.....
(1)

(c) Work out the area of the trapezium.

..... cm²
(2)

(d) Work out the volume of the prism.

..... cm³
(2)

(Total for Question 14 is 6 marks)



- 15 The table gives information about the numbers of goals scored by a football team in 30 matches.

Number of goals scored	Frequency
0	2
1	10
2	7
3	6
4	3
5	2

- (a) Find the median number of goals scored.

.....
(2)

- (b) Find the mean number of goals scored.

.....
(3)

(Total for Question 15 is 5 marks)

Do NOT write in this space.



16 The diagram shows a shape **P**, a shape **Q** and a line AB .

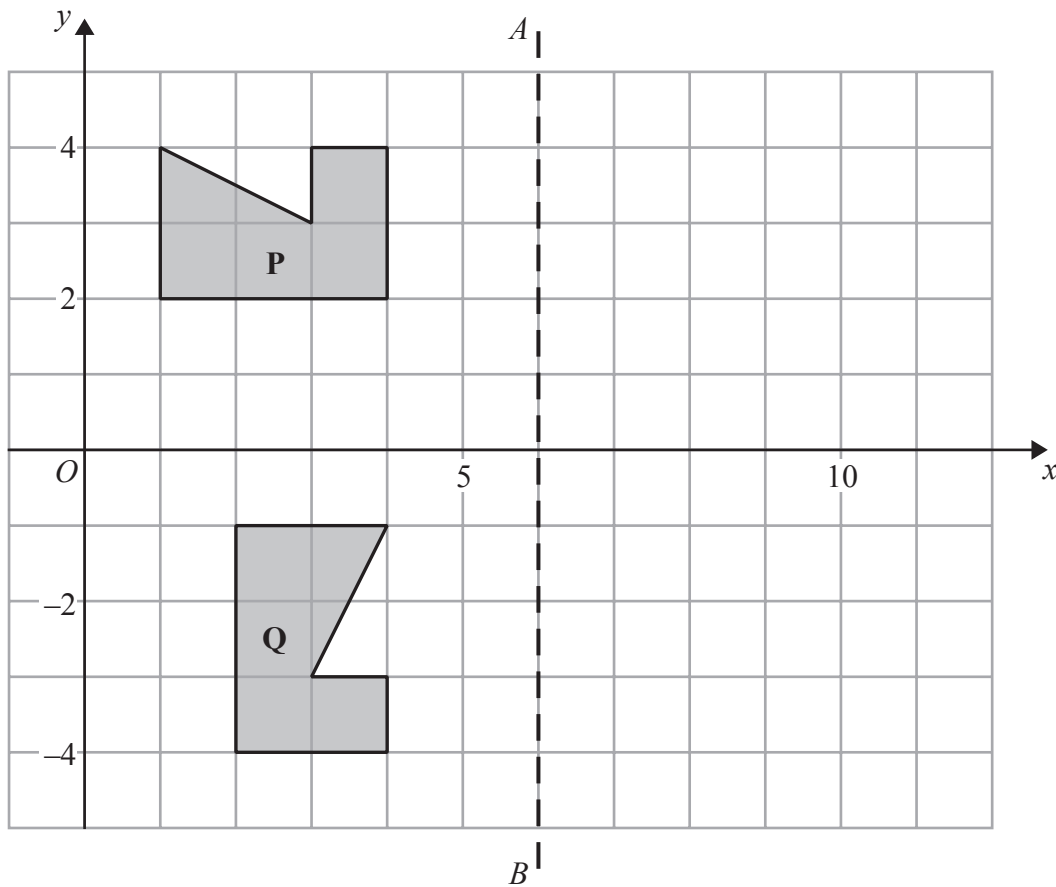

(a) Write down an equation of the line AB .

.....
(1)

(b) Reflect shape **P** in the line AB .

(2)

(c) Describe fully the single transformation which maps shape **P** onto shape **Q**.

.....
.....
(3)

(Total for Question 16 is 6 marks)

Do NOT write in this space.

17 (a) Simplify $k \times k \times k \times k \times k$

.....
(1)

(b) Expand $2(7t - 3)$

.....
(1)

(c) Expand and simplify fully

(i) $4(2y + 6) - 3(2y - 7)$

(ii) $(x - 6)(x - 4)$

.....
(4)

(d) Simplify fully $\frac{v^4 \times v^7}{v^5}$

.....
(2)

(Total for Question 17 is 8 marks)

Do NOT write in this space.



18 A school has 840 pupils and 40 teachers.

- (a) Find the ratio of the number of pupils to the number of teachers.
Give your ratio in the form $n : 1$

..... : 1
(2)

In Year 11 at the school, the ratio of the number of pupils who study Chemistry to the number of pupils who study Physics is 3 : 2

- (b) 105 pupils in Year 11 study Chemistry.
Work out the number of pupils in Year 11 who study Physics.

.....
(2)

For the 105 pupils who study Chemistry, the ratio of the number of boys to the number of girls is 4 : 3

- (c) Work out the number of girls in Year 11 who study Chemistry.

.....
(2)

(Total for Question 18 is 6 marks)

Do NOT write in this space.



19 A square hole is cut from a circular piece of card.

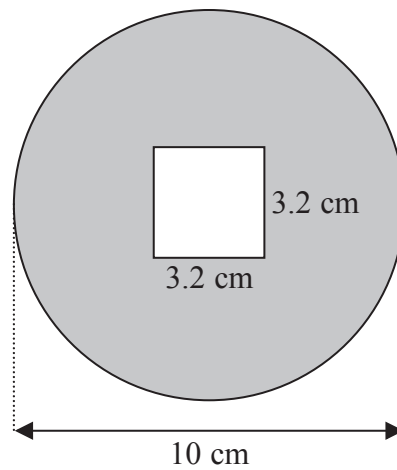

Diagram **NOT**
accurately drawn

The square has sides of length 3.2 cm.
The diameter of the circular piece of card is 10 cm.

Work out the area of the shaded region.
Give your answer correct to 3 significant figures.

..... cm²

(Total for Question 19 is 4 marks)

20 Express 825 as a product of its prime factors.

.....

(Total for Question 20 is 3 marks)



- 21 $\mathcal{E} = \{\text{positive whole numbers less than } 13\}$
 $A = \{\text{even numbers}\}$
 $B = \{\text{multiples of } 3\}$
 $C = \{\text{prime numbers}\}$

(a) List the members of the set

(i) $A \cap B$

.....

(ii) $B \cup C$

.....

(2)

(b) Is it true that $14 \in A$?

Tick (\checkmark) the appropriate box.

Yes

No

Explain your answer.

.....

(1)

(Total for Question 21 is 3 marks)

- 22 The mean of four numbers is 2.6
 One of the four numbers is 5

Find the mean of the other three numbers.

.....

(Total for Question 22 is 3 marks)

TOTAL FOR PAPER IS 100 MARKS



P 4

PAPACAMBRIDGE



2 0

BLANK PAGE

Do NOT write on this page.