

Surname	Centre Number	Candidate Number
Other Names		0



**GCSE – NEW**

3400U10-1



S17-3400U10-1

**BIOLOGY – Unit 1:  
Cells, Organ Systems and Ecosystems**

**FOUNDATION TIER**

WEDNESDAY, 14 JUNE 2017 – MORNING

1 hour 45 minutes

For Examiner's use only		
Question	Maximum Mark	Mark Awarded
1.	7	
2.	8	
3.	8	
4.	9	
5.	10	
6.	12	
7.	6	
8.	8	
9.	12	
<b>Total</b>	<b>80</b>	

3400U101  
01

**ADDITIONAL MATERIALS**

In addition to this paper you may require a calculator and a ruler.

**INSTRUCTIONS TO CANDIDATES**

Use black ink or black ball-point pen.

Write your name, centre number and candidate number in the spaces at the top of this page.

Answer **all** questions.

Write your answers in the spaces provided in this booklet.

**INFORMATION FOR CANDIDATES**

The number of marks is given in brackets at the end of each question or part-question.

Question 7 is a quality of extended response (QER) question where your writing skills will be assessed.

Answer all questions.

1. The diagram below shows a section through a plant cell as seen with a light microscope.

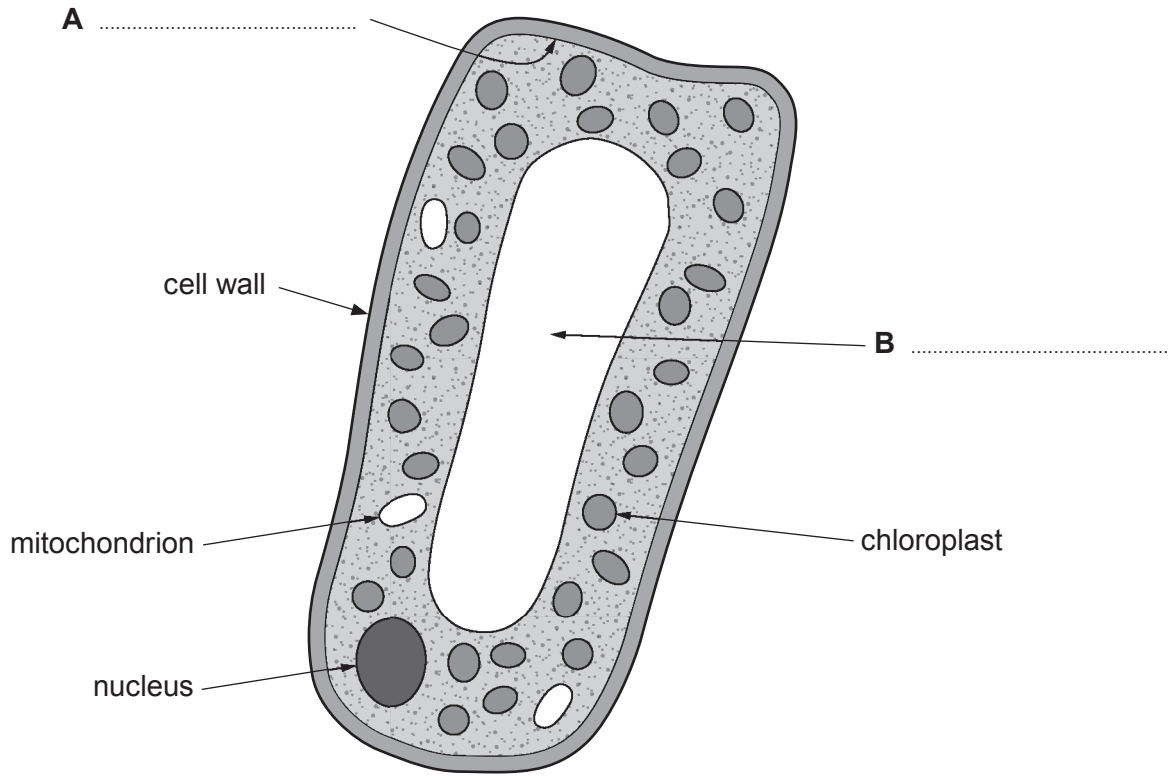

- (a) (i) Label parts **A** and **B** on the diagram. [2]  
 (ii) Complete the table below. [3]

Part of cell	Function	Cell part present (✓) or absent (×) in animal cell
.....	photosynthesis	.....
mitochondrion	.....	✓
.....	contains the chromosomes	.....

(b) The photograph below shows some plant cells as seen under a light microscope.

The group of cells labelled **Z** has been treated using a procedure to make their cell walls more clearly visible.

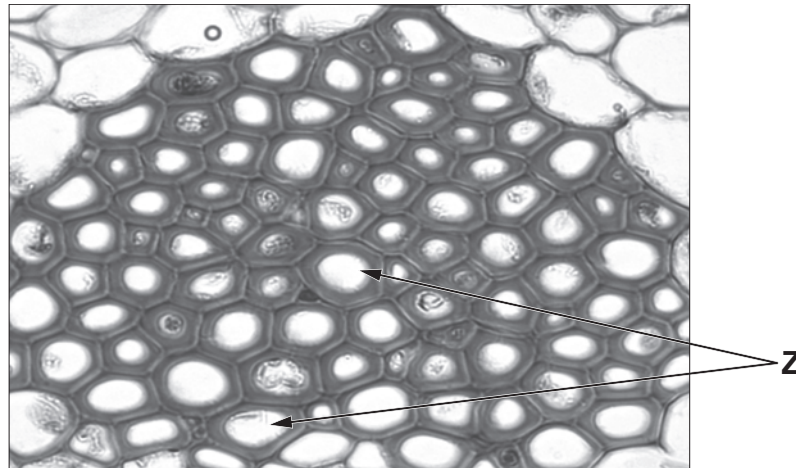

(i) What was the procedure carried out on these plant cells while they were prepared for viewing under the microscope? [1]

.....

(ii) When the microscope was used to view these plant cells the magnification of the eyepiece lens was  $\times 10$  and the magnification of the objective lens used was  $\times 10$ .

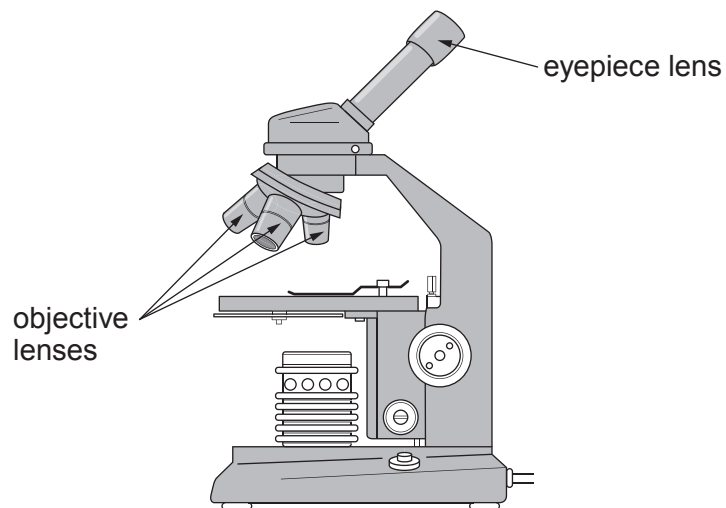

Using this information, calculate the total magnification of the image. [1]

Magnification =  $\times$  .....

2. The diagram below shows a food web.

Examiner  
only

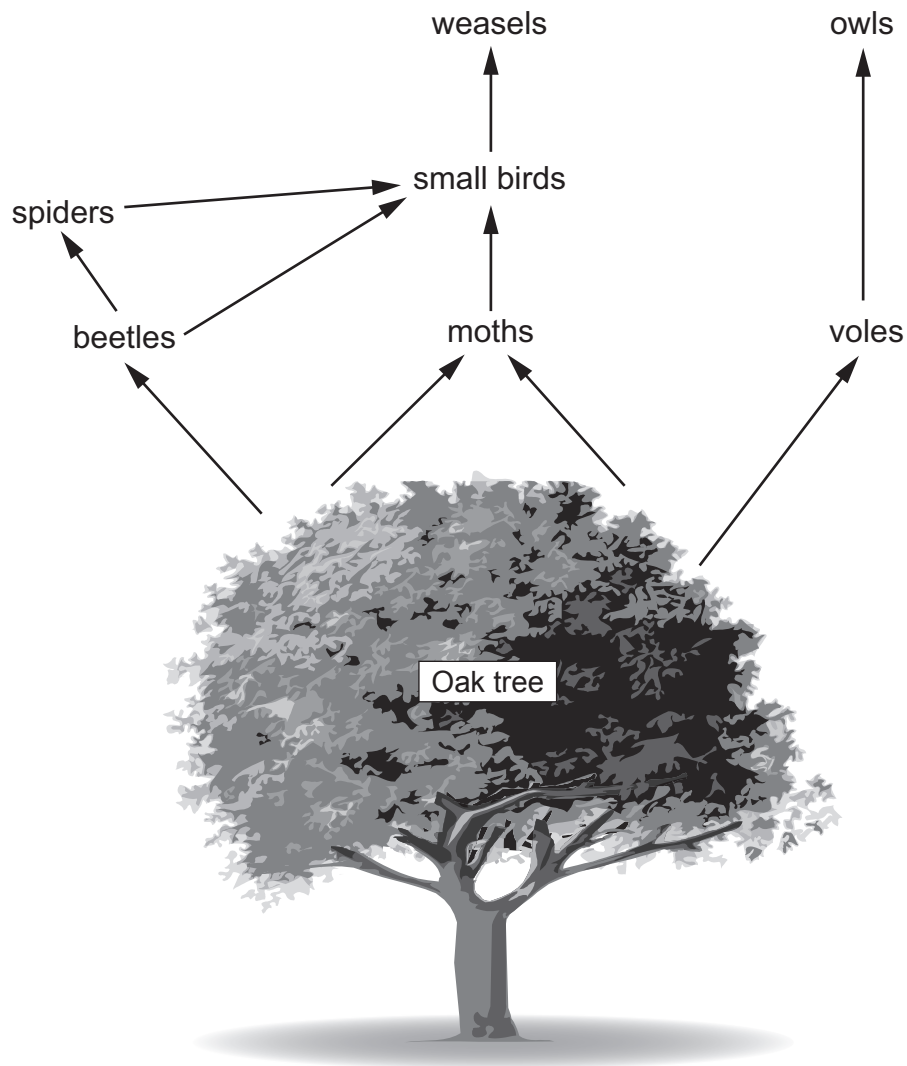

(a) (i) State the source of energy for the food web. [1]

.....

(ii) State **one** way in which energy can be lost from the food web. [1]

.....

(b) Circle *true* or *false* in the table for each of the following statements about this food web. [3]

Statement			
1	Moths and voles are first stage consumers.	true	false
2	Owls are third stage consumers.	true	false
3	Small birds are both third stage and second stage consumers.	true	false
4	Weasels and spiders are second stage consumers.	true	false
5	The oak tree is the only producer.	true	false

(c) (i) Complete the flow diagram below to show **one food chain** from the food web. [1]

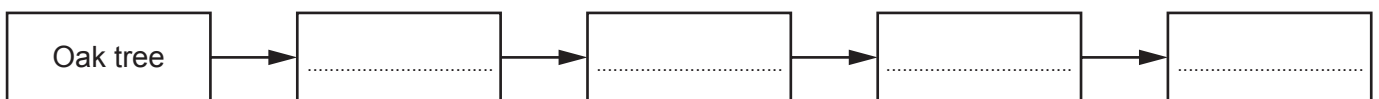

(ii) **Draw a pyramid of biomass** to represent this food chain, in the space below.

Label each level in the pyramid with the name of the organism.

[2]

8

3400U101  
05

3. Read the information about seagrass and use it to answer the questions.



**Seagrass growing on the sea bed**

Seagrass is a green plant which lives in the sea. It covers large areas of the sea bed.

Human activities such as dredging, building and industrial development can destroy seagrass. In the 1950s the loss of seagrass was 1.5% per year but since 1990 scientists have calculated the loss to be 7% per year.

Fisheries need sea grass. In the Mediterranean Sea, between 30% and 40% of the fish caught feed on seagrass and in Indonesian seas this is 60%.

Seagrass is important in the carbon cycle, taking in carbon dioxide to produce glucose. This is converted into another carbon compound which can be stored in its large roots. Carbon dioxide makes sea water acidic which is harmful to sea organisms.

(a) Answer the following questions using only the information given.

- (i) Give **one** reason why areas of seagrass are lost. [1]

- (ii) Which of the following statements describes the rate at which seagrass has been lost since 1950? [1]

- A** It has been constant every year
- B** It has increased
- C** It has decreased
- D** It has increased in some years and decreased in others.

Answer

(b) Answer the following questions using only the information given.

(i) Which statement describes how much the fishing industry depends on seagrass? [1]

- A Mediterranean and Indonesian fisheries depend totally on seagrass.
- B Mediterranean fisheries depend on seagrass for most of their fish.
- C Indonesian fisheries depend on seagrass for less than half of their fish.
- D Indonesian and Mediterranean fisheries depend on seagrass for some of their fish.

Answer

(ii) Apart from providing food, explain how seagrass is helpful to other species which live in the sea. [2]

.....

.....

(c) Answer the following questions using the information given and your own knowledge.

(i) Complete the diagram below which shows part of the carbon cycle, by naming processes X and Y. [2]

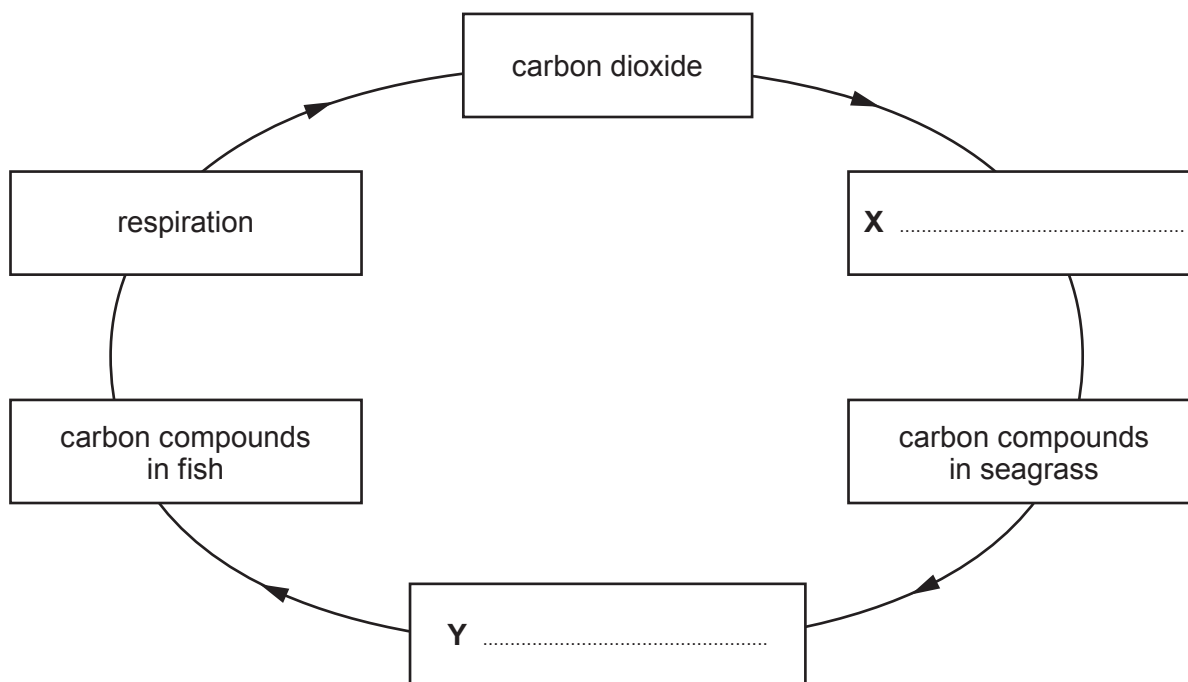

(ii) Name the carbon compound stored in the roots of seagrass. [1]

.....

4. (a) The diagram below is a section through the human thorax during expiration (breathing out).

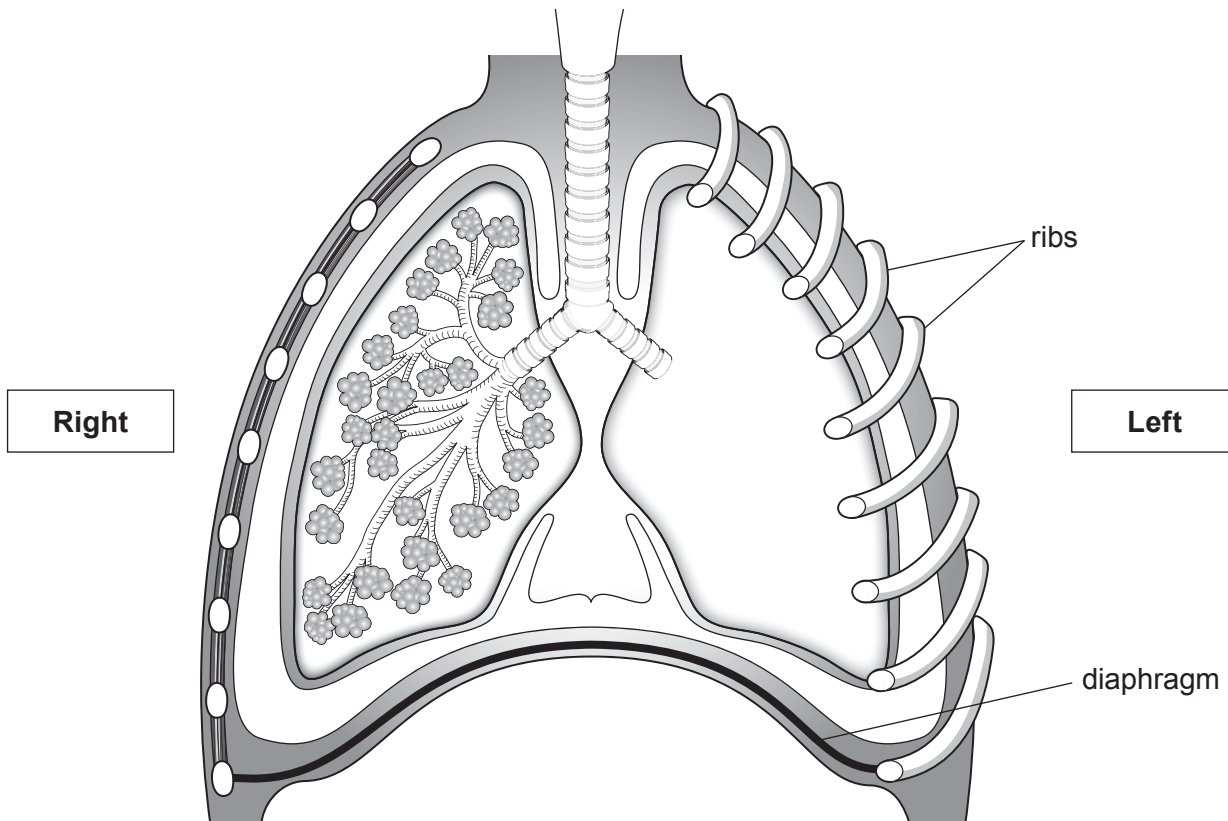

On the diagram, **draw**

- (i) **a line** to show the shape of the diaphragm at the end of inspiration (breathing in); [1]
- (ii) **an arrow** on the diagram to show the path taken by air passing from the trachea to a bronchiole in the **right** lung. [1]



(b) The diagram below shows a single alveolus.

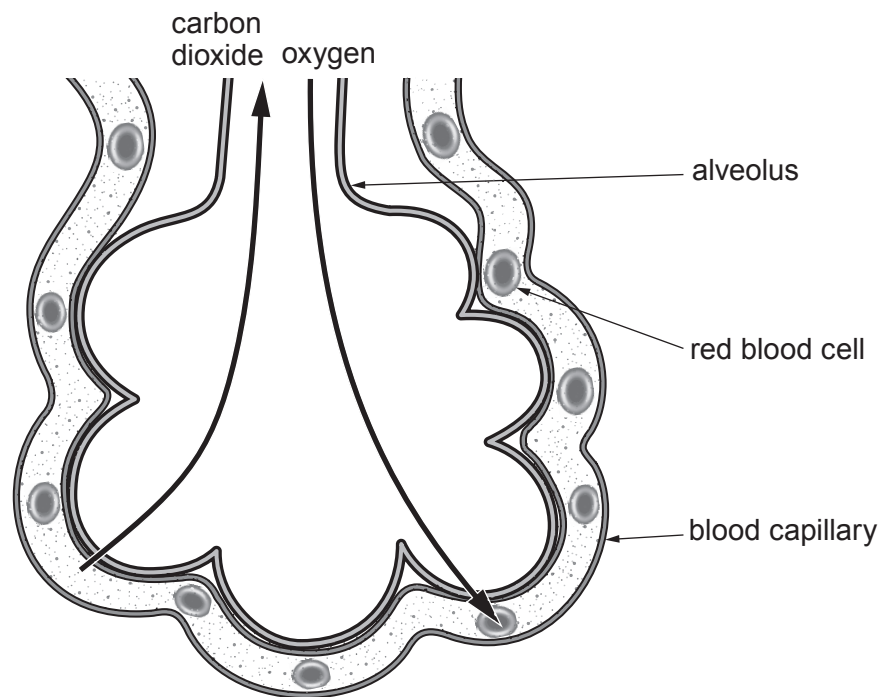

Gas exchange between the alveolus and the blood in the capillary occurs through the wall of the alveolus.

Answer the following questions using information from the alveolus diagram above and your own knowledge.

(i) Name the process by which gas exchange occurs. [1]

.....

(ii) Describe **two** ways in which the structure of the alveolus is adapted for this function. [2]

1. ....

2. ....

- (c) Cigarette smoking damages the lungs and causes lung cancer. In 2009, doctors investigated lung cancer and cigarette smoking in men in a city in the UK. The highest proportion of smokers was found to be in the age range 20-29. The cases of lung cancer are shown in the graph below.

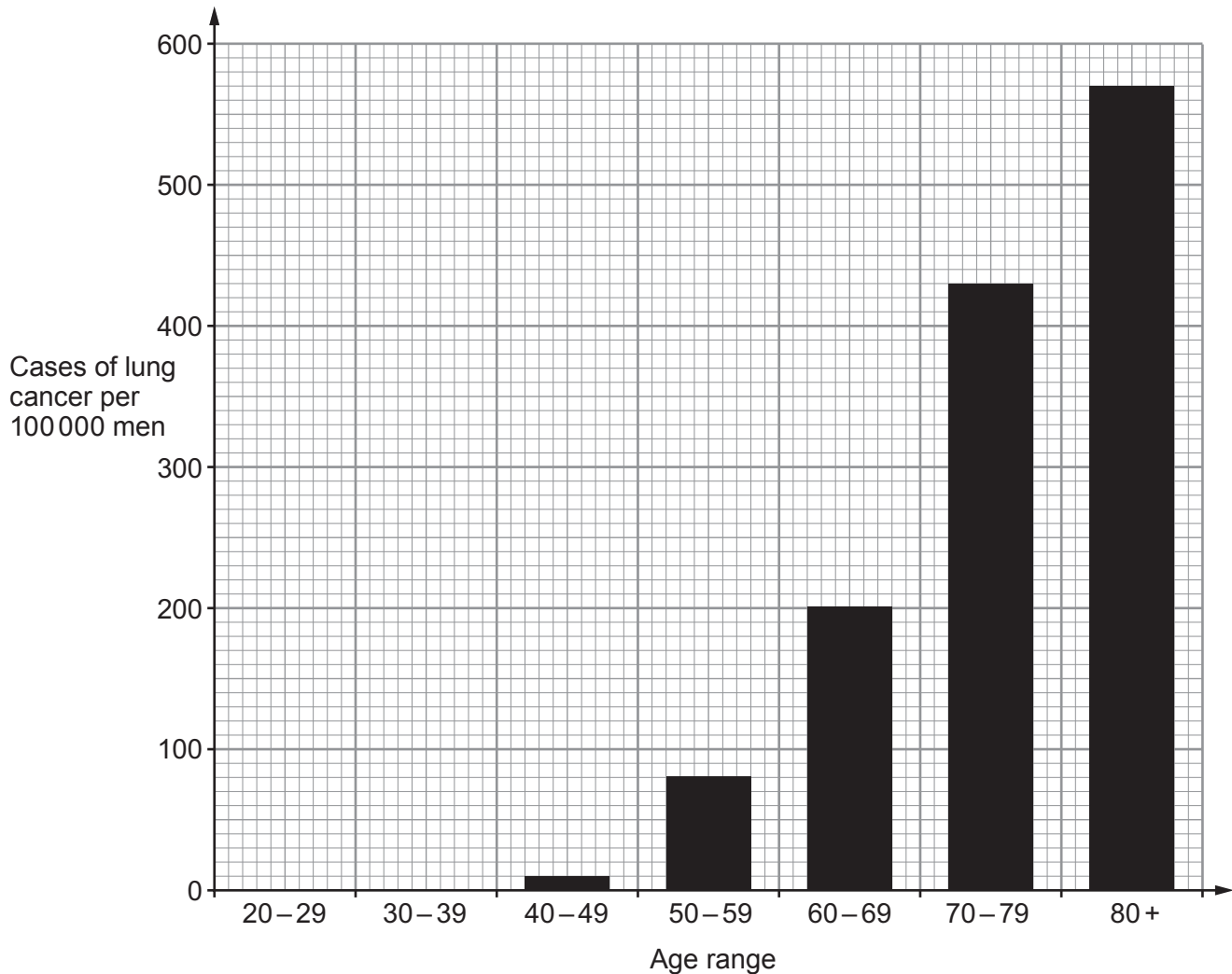

- (i) State the conclusion the doctors should reach using the data given in the graph. [1]

- (ii) What is the evidence that lung cancer takes a long time to develop? [1]

Examiner  
only

(iii) State **two** ways in which this investigation could be improved so that the doctors could be more confident that their results were representative of the whole of the population of the UK. [2]

1. ....

2. ....

9

3400U101  
11

5. A sample of human blood was placed in a test tube and the contents were separated by spinning the tube at high speed in a laboratory centrifuge. The diagram below shows the results.

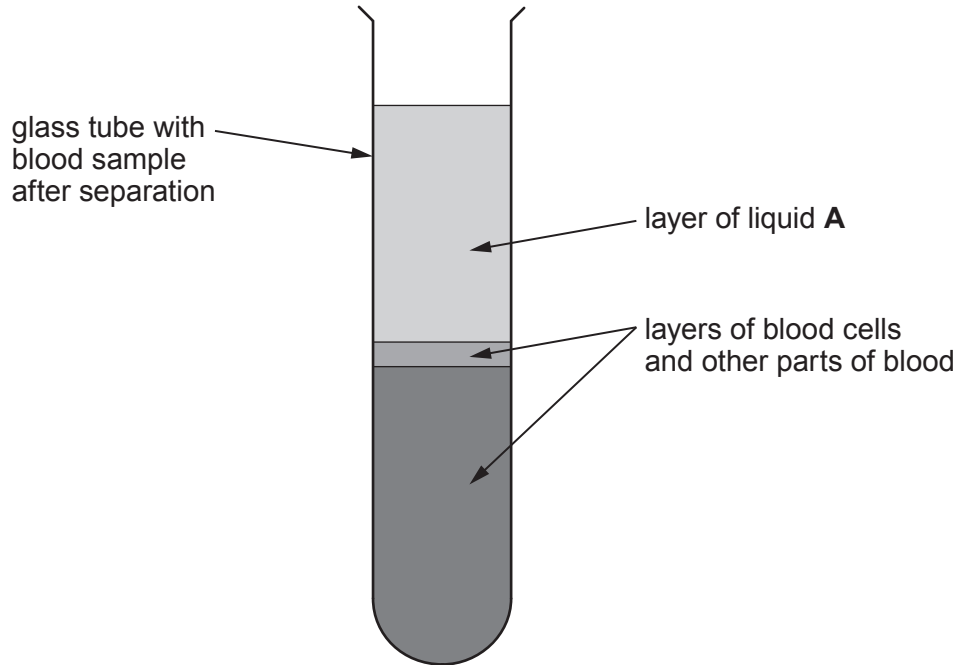

- (a) (i) The drawing below shows a red blood cell.

In the space, draw **another** type of cell which would be found in the sample.

State the name of the cell and its function.

[3]

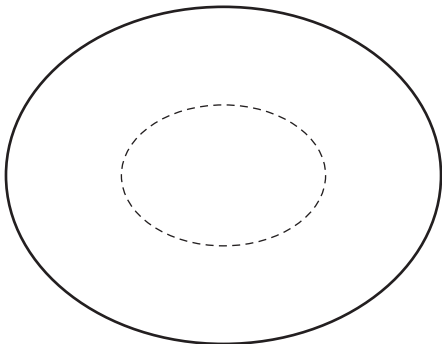
<p>Red blood cell</p>  <p>Function – carries oxygen</p>	<p>Name of cell .....</p> <p>Function .....</p>
--	---

Examiner  
only

- (ii) Name the liquid in layer **A** in the sample and state **two** substances which it transports. [3]

Name of liquid .....

Substances transported

1. ....

2. ....

- (iii) The volume of the blood sample was  $20\text{ cm}^3$ . Liquid **A** accounts for 45% of this volume.  
Calculate the volume of liquid **A**. [2]

Volume = .....  $\text{cm}^3$

- (b) A laboratory technician was working on some blood samples. She noticed that if the samples were left to stand for five minutes before placing them in the centrifuge, they could not be separated properly, as they had started to solidify.

Use your knowledge of the functions of the parts of blood to explain this observation. [2]

.....  
.....  
.....

10

6. Respiration is a series of enzyme controlled reactions which release energy. The word equation for aerobic respiration is shown below.



Bethan investigated the effects of temperature on the rate of aerobic respiration in yeast. She used the apparatus below.

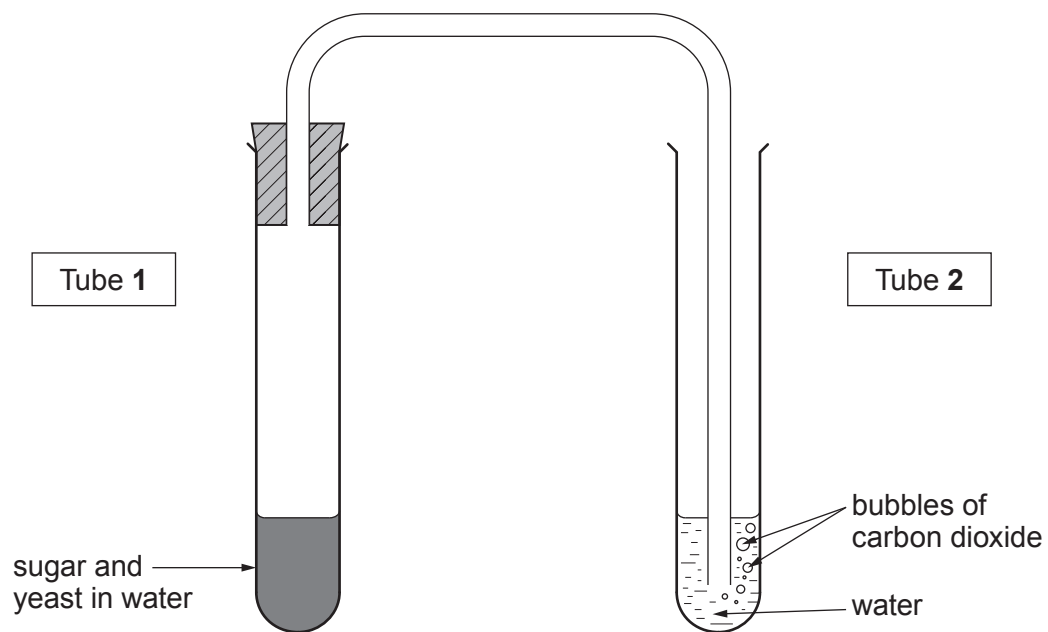

Bethan carried out the investigation at a range of temperatures from 15 °C to 45 °C.

- (a) Name the apparatus she could use in order to control the temperature.

[1]

.....

(b) The table shows the results from the investigation.

Temperature (°C)	Rate of respiration (bubbles / minute)
15	19
25	50
30	64
35	80
40	84
45	67

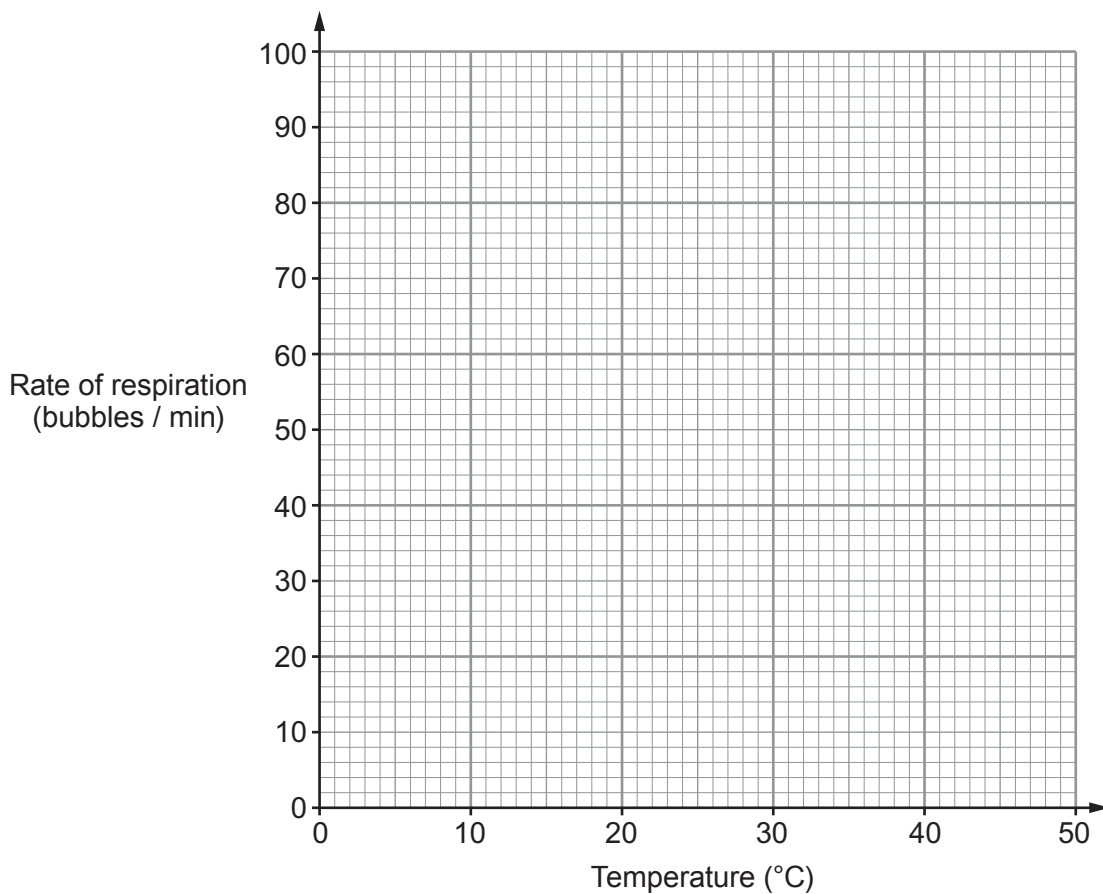

(i) Produce a graph of the results by:

[3]

- I. Plotting the values from the table.
- II. Drawing a line to join your plots using a ruler.

Examiner  
only

(ii) I. Describe how the rate of respiration changes as the temperature is increased. [2]

.....  
.....

II. Explain the reason for the change in the rate between 25°C and 35°C. [2]

.....  
.....

(c) Bethan was told that she could improve her investigation by confirming that the bubbles of gas given off by the yeast actually were carbon dioxide.

(i) Name the solution she could use in tube **2** of the apparatus to test for carbon dioxide and state the positive result. [2]

.....  
.....

(ii) State **two** factors which she should have kept constant in tube **1** throughout the investigation to ensure that it was a fair test. [2]

1. ....

2. ....

12





8. Shoots from two different species of plants, **A** and **B**, were placed in water in boiling tubes as shown below.

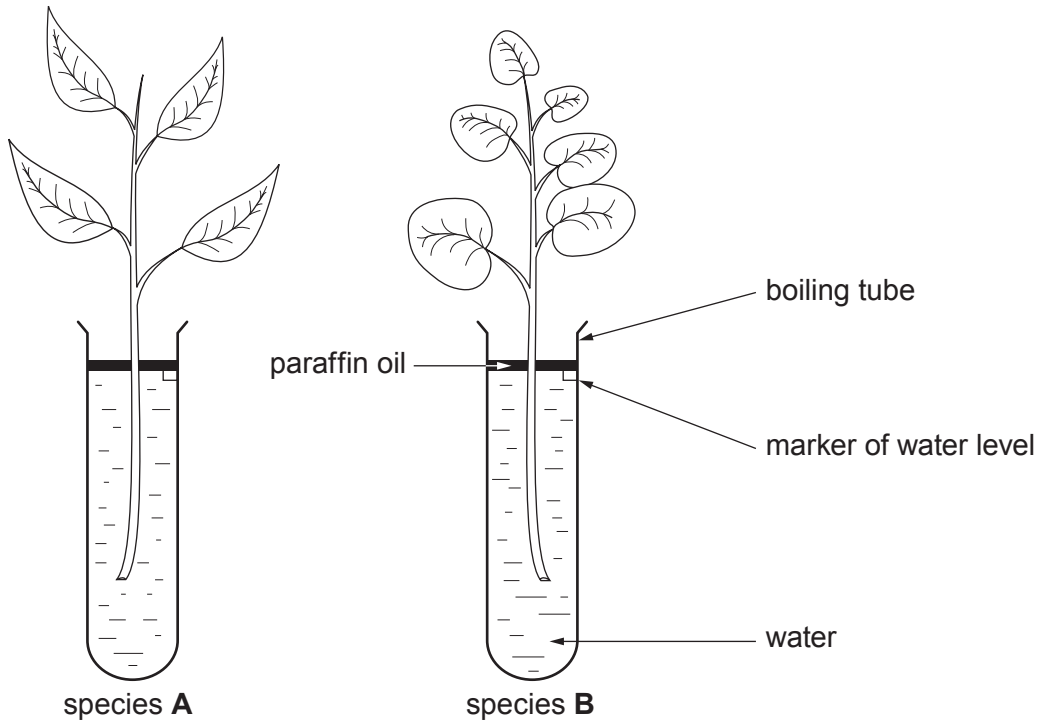

Both species were kept in the same conditions and their mass recorded at hourly intervals for eight hours. The results were recorded as line graphs shown below.

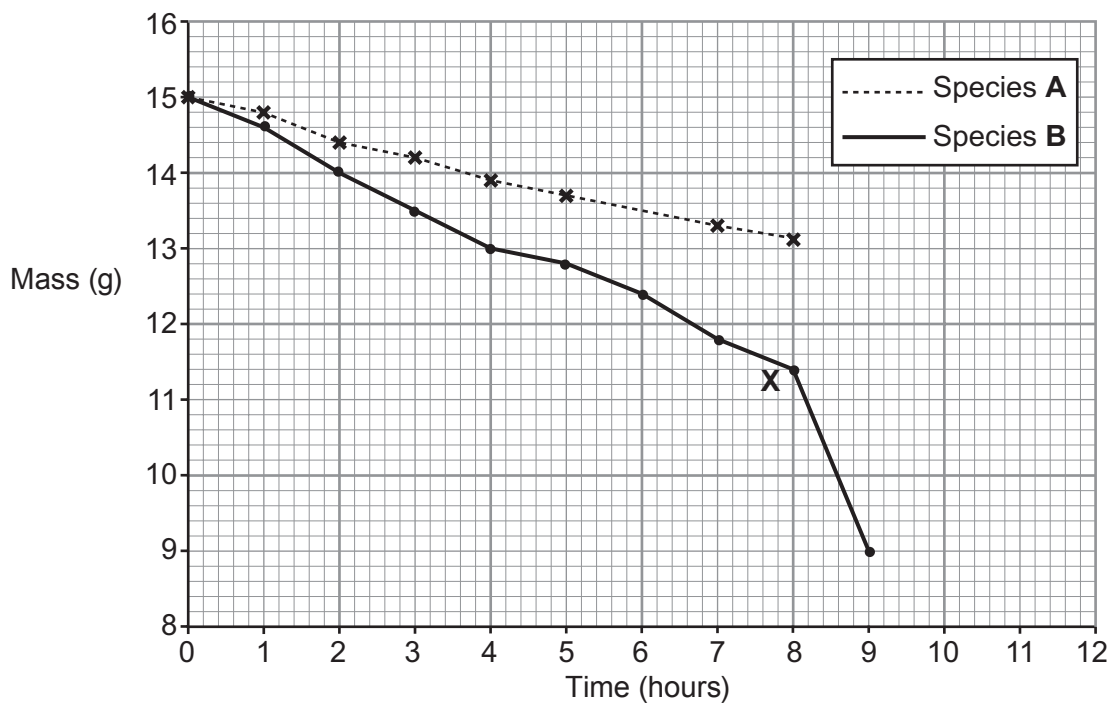

- (a) (i) Use the data to calculate the difference in the loss in mass between species **A** and **B** at 8 hours. [1]

Difference in loss of mass = ..... g

- (ii) State the term given to the process responsible for this loss of mass in plants. [1]
- .....

- (iii) Suggest **two** reasons for the difference in loss of mass between the two different species, **A** and **B**. [2]

1. ....

2. ....

- (iv) State the purpose of the paraffin oil in the boiling tubes. [1]
- .....
- .....

- (b) Which **one** of the following treatments was applied to species **B**, at point **X** on the graph, to produce the result shown at 9 hours?

Underline the correct answer. [1]

**Enclosed in a bell jar**

**Upper surface of leaves coated with Vaseline**

**Half the leaves removed**

**Air directed at the leaves by a fan**

- (c) What would you expect to happen to the rate of loss of mass if species **A** and **B** had roots? Give a reason for your answer. [2]
- .....
- .....
- .....

9. The drawing shows the lining of part of the digestive system.

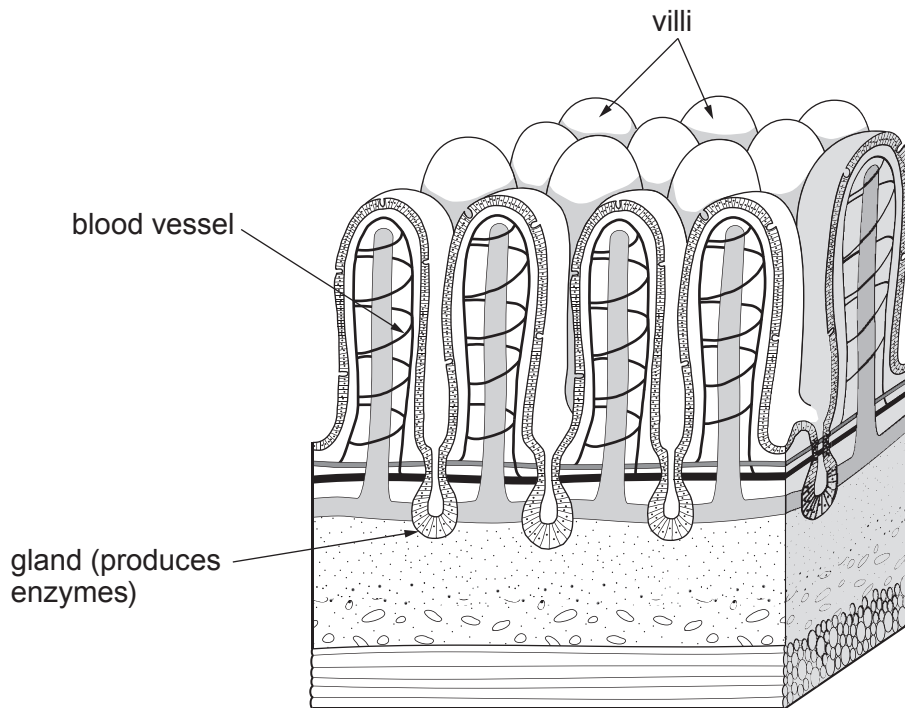

- (a) Name the part of the digestive system that has this lining. [1]

- (b) If the surface area of a single villus is  $5 \text{ mm}^2$ , calculate the total surface area of all the villi shown. Assume that all the villi are complete and include a unit in your answer. [1]

Total surface area = .....

unit = .....

- (c) State **two** functions carried out in this part of the digestive system. [2]

Function 1. ....

Function 2. ....

(d) State **one** feature of the digestive system which helps this part carry out each function named in (c). [2]

Function 1. ....

Function 2. ....

(e) Fresh pineapple is sometimes added to meat to make it tender. Fresh pineapple contains a protease enzyme.

Alan investigated how this took place. He used the following:

- fresh pineapple
- pineapple that had been heated to 100 °C and cooled
- a solid jelly made from protein called gelatin

Two samples of solid jelly were made and the pineapple was pushed into them. After 24 hours the results were shown below:

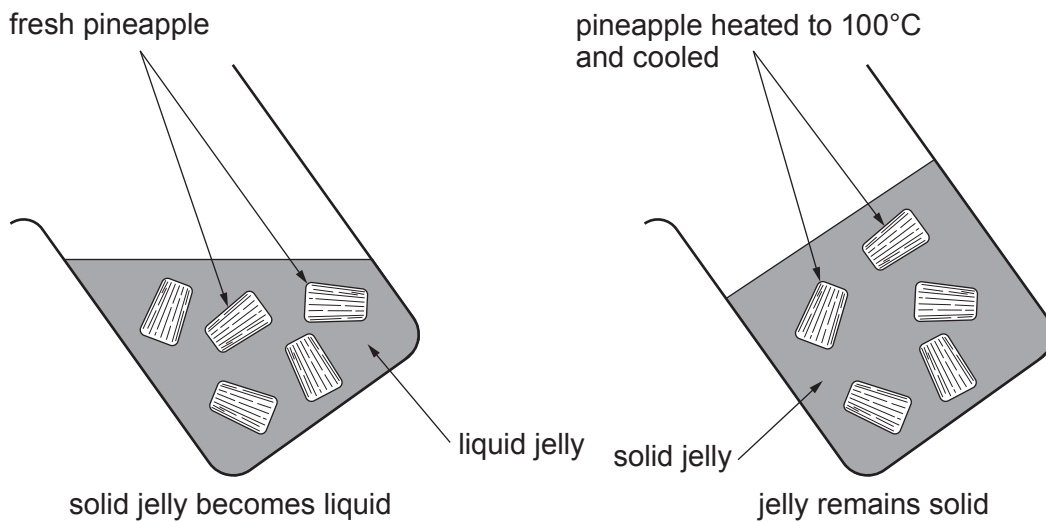

Explain the results with:

(i) fresh pineapple; [3]

.....

.....

.....

.....

.....

(ii) pineapple heated to 100 °C and cooled. [3]

.....

.....

.....

**BLANK PAGE**

**BLANK PAGE**